



G620a & A6301 Cameras

User's Manual



Revision: B

Issue Date: May - 2024

Teledyne Confidential; Commercially Sensitive Business Data

WARNING - This document contains technology subject to the Export Administration Regulations (EAR) (15 C.F.R. Sections 730- 774). Export or diversion contrary to law is prohibited. (EAR99)

<http://flir.custhelp.com>

www.flir.com

©2022 FLIR Systems, Inc.

Teledyne Confidential; Commercially Sensitive Business Data

G620a & A6301 Camera's User's Manual

WARNING – EAR Controlled Technology (EAR99)

Table of Contents

1	REVISION HISTORY	6
2	INTRODUCTION	7
2.1	Delivered Camera System Components.....	7
2.2	Camera Models.....	8
2.3	Camera Specifications.....	8
3	WARNINGS AND CAUTIONS.....	12
4	INSTALLATION	13
4.1	Camera Parts	13
4.1.1	Status/Indicator LEDs.....	13
4.1.2	PoE Connector	14
4.1.3	AUX Connector.....	15
4.1.4	Factory Reset Button.....	17
5	CONNECTING TO THE CAMERA FOR THE FIRST TIME	18
5.1	Forgot Username/Password.....	18
5.2	Forgot IP Address and/or Incorrect IP Settings.....	18
5.3	Default Network Configuration.....	19
6	CAMERA THEORY OF OPERATION	20
6.1	Basic Camera Components.....	20
6.2	Simplified Image Data Processing Pipeline.....	22
6.2.1	Calibration	22
6.2.2	AGC.....	24
6.2.3	Digital Zoom	27
6.2.4	Color Pallet.....	27
6.2.5	Radiometric vs Nonradiometric Data.....	28
6.2.6	RTSP	28
6.2.7	GigE Vision.....	28
6.3	Autofocus (G620a)	28
6.3.1	Autofocus ROI	28
6.4	Frame Latency	28
6.4.1	Frame Latency and the A6301	28
6.4.2	Frame Latency and the G620a.....	29

Teledyne Confidential; Commercially Sensitive Business Data

G620a & A6301 Camera's User's Manual

WARNING – EAR Controlled Technology (EAR99)

7	OPERATING THE CAMERA	30
7.1	Non-Radiometric Data Users.....	30
7.2	Radiometric Data Users.....	30
7.3	Using the REST API.....	30
7.4	Accessing the RTSP Video Streams.....	30
7.4.1	Opening Stream in VLC.....	31
8	WEB BROWSER	32
8.1	Home Page.....	32
8.2	Video Page.....	33
8.3	Thermal Page.....	35
8.4	I/O Page.....	38
8.5	OSD Page.....	40
8.6	Camera System Settings.....	41
8.6.1	Network Tab.....	41
8.6.2	Date & Time Tab.....	43
8.6.3	User's Tab.....	43
8.6.4	Temperature Tab.....	45
8.6.5	Cyber Tab.....	45
8.6.6	Firmware & Info Tab.....	49
9	FLIR CAMTOOLS	52
9.1	Camera IP Config.....	52
9.2	Camera PlayIR.....	53
9.2.1	Menu Bar Functions.....	53
9.3	Camera Controller.....	57
9.3.1	Hamburger Menu.....	59
9.3.2	Camera Controller – Setup Tab.....	59
9.3.3	Camera Controller – Digital I/O Tab.....	63
9.3.4	Camera Controller – Streaming Tab.....	64
10	MAINTENANCE	67
10.1	Camera Body, Cables, and Accessories.....	67
10.2	Lenses.....	67
APPENDIX A -	G620A MECHANICAL DIMENSIONS	68
APPENDIX B -	A6301 MECHANICAL DIMENSIONS	71

Teledyne Confidential; Commercially Sensitive Business Data

G620a & A6301 Camera's User's Manual

WARNING – EAR Controlled Technology (EAR99)

Teledyne Confidential; Commercially Sensitive Business Data

G620a & A6301 Camera's User's Manual

WARNING – EAR Controlled Technology (EAR99)

2 Introduction

Thank you for choosing the FLIR G620a or A6301 camera!

The FLIR G620a is an infrared camera for optical gas imaging (OGI) that allows oil and gas operators, and other industrial markets, a solution for continuous and autonomous leak detection. The FLIR G620a is used in industrial settings such as natural gas processing plants, biogas and power generation plants and helps to protect the environment by tracing leaks of methane.

The A6301 family of cameras offers a new level of thermal imaging capabilities to process control and quality assurance applications in the manufacturing industry. With the ability to detect small thermal variations and accurately measure temperatures on moving products, the new A6301 gives machine builders and integrators a cutting-edge tool to tackle the difficult machine vision applications. Simple standard GEV and GeniCam industry protocols make it easy to implement and the long-life cooler reduces the concerns for costly annual maintenance.

The G620a and A6301 camera families use the same base camera body with a slight difference in spectral range and lens option. These differences make the G620a ideal for OGI applications while the A6301 is best suited for Automation type applications. For this User's Guide, "the camera" refers to either camera whereas camera family specifics are addressed by the actual camera family, G620a or A6301.

2.1 Delivered Camera System Components

The Camera and its accessories are delivered in a box which typically contains the items below:

- Camera w/Lens
- Cable Assy: M12 X-code RJ45F, 0.3m
- Quick Start Guide
- Calibration Certificate

Additional accessories which may be useful, and can be purchased separately, are listed below:

Description	FLIR Part Number
Ethernet cable M12 to RJ45, 2 m	T911854ACC
Cable M12 to pigtail, 2 m	T911852ACC
Ethernet cable CAT-6, 2m/6.6 ft.	T951004ACC
Gigabit PoE injector 30 W	T912049ACC

2.2 Camera Models

The Camera can be ordered with different lens options. While the lenses are mechanically interchangeable, the camera comes factory calibrated with the delivered lens. Changing lenses will result in inaccurate temperature measurements.

G620a	Lens	FLIR Part Number
f/1.59 T2SLS: 3.2-3.4 μ m response	6° Motorized Lens	29434-201
	14.5° Motorized Lens	29434-202
	24° Motorized Lens	29434-203
A6301	Lens	FLIR Part Number
f/2.5 T2SLS: 3.0-5.0 μ m response	17mm Manual Lens	29433-206
	25mm Manual Lens	29433-207
	50mm Manual Lens	29433-208

2.3 Camera Specifications

Thermal Sensor	
Array Format	640x512
Frame Rate	30Hz (user selectable 1Hz - 30Hz)
Detector Type	Hot MWIR T2SLS
Sensor Cooling	FLIR FL100 Linear Cooler
Pixel Pitch	15 μ m
Spectral Range	G620a: 3.2 μ m – 3.4 μ m A6301: 3.0 μ m – 5.0 μ m
Sensitivity (NEΔT)	< 15mK Typical (33mS integration @ 25C)
Measurement Temperature Range	G620a: -10C to 120C A6301: -20C to 200C
Available Sub Ranges	G620a: -10C to 30C; 10C to 60C; 30C to 80C; 55C to 120C A6301: -20C to 55C; 35C to 150C; 80C to 200C

Teledyne Confidential; Commercially Sensitive Business Data

G620a & A6301 Camera's User's Manual

WARNING – EAR Controlled Technology (EAR99)

Ambient Drift Compensation	Yes		
Accuracy	$\leq 100^{\circ}\text{C}$: $\pm 2^{\circ}\text{C}$ $> 100^{\circ}\text{C}$: $\pm 2\%$ of reading		
Optics – G620a			
Model Number	29434-201	29434-202	29434-203
FOV	6.0°x4.8°	14.4°x11.5°	23.6°x19.0°
Focal Length	92mm	38mm	23mm
F/#	f/1.59		
Focus	Motorized		
Optical Zoom	No		
Optics – A6301			
Model Number	29433-206	29433-207	29433-208
FOV	31.5°x25.5°	21.7°x17.5°	11.0°x8.8°
Focal Length	17mm	25mm	50mm
F/#	f/2.5		
Focus	Manual		
Optical Zoom	No		
Video			
Video Type	IP (RTSP)	GigE Vision	
Pixel Value	8-bit, non-radiometric data	16-bit, radiometric data	
Number Streams	2	1	
IP Video Compression	H.264 / MJPEG	None	

Teledyne Confidential; Commercially Sensitive Business Data

G620a & A6301 Camera's User's Manual

WARNING – EAR Controlled Technology (EAR99)

Radiometric	No	Yes
Thermal Image Settings	Auto AGC – Linear, PE Manual - Linear	N/A (Handled by Host software)
Thermal AGC Region of Interest (ROI)	Default and user-definable to ensure optimal image quality on subjects of interest	
Digital Zoom	x1, x2, x4, x8	
Selectable Color Pallets	Yes	
Image Uniformity Optimization	Flat Field Correction (FFC) <ul style="list-style-type: none"> • Automatic <ul style="list-style-type: none"> ○ thermal and temporal triggers • Manual 	
System Integration		
Video Type	IP (RTSP)	GigE Vision
Provided Display and Control Software	Web Browser	FLIR Camera PlayIR
User Custom Control	REST API	GeniCam
Ethernet	100/1000 Mbps	
Digital I/O	Input: Two 24V inputs Output: Two relay Contacts	
General		
Primary Power Source	PoE: Type 2, 30W	
Optional DC Power Source	Rear Panel AUX connector	
Power Consumption	25W (cool down)	

Teledyne Confidential; Commercially Sensitive Business Data

G620a & A6301 Camera's User's Manual

WARNING – EAR Controlled Technology (EAR99)

DC Voltage Range	15V-56V
Environmental	
IP Rating (Dust & Water Ingress)	IP50
Operating Temperature	-20°C to 50°C
Shock	25g, 6ms; Half sine; +- 500 shocks; X,Y&Z (IAW MIL-STD-810H)
Vibration	MIL-STD-810H
Compliance & Certifications	
<ul style="list-style-type: none"> • EMC: 2014/30/EU, WEEE: 2012/19/EU • EN55032:2015/A11:2020 • EN55035:2017/A11:2020 • FCC Part 15, Subpart B Class A • KC C 9832 and KS C 9835 	

3 Warnings and Cautions

For best results and user safety, the following warnings and precautions should be followed when handling and operating the camera:

Warnings and Cautions

- **Do not open the camera body for any reason. Disassembly of the camera (including removal of the cover) can cause permanent damage and will void the warranty.**
- **Great care should be exercised with your camera optics. Refer to Chapter 10 for lens cleaning.**
- **Operating the camera outside of the specified input voltage range or the specified operating temperature range can cause permanent damage.**
- **The camera is not completely sealed. Avoid exposure to dust and moisture and replace the lens cap when not in use.**
- **Do not image extremely high intensity radiation sources, such as the sun, lasers, arc welders, etc.**
- **The camera contains static-sensitive electronics and should be handled appropriately.**



4 Installation

4.1 Camera Parts



Item	Description
1	Removable lens (G620a lens shown)
2	Base camera body
3	Ethernet/PoE connector, X-coded
4	Status/Indicator LEDs
5	Auxiliary Connector, A-coded
6	Factory Reset Button
7	microSD Card Slot (not currently implemented)



4.1.1 Status/Indicator LEDs

LED	Description
	Power – When illuminated, appropriate power has been applied to the camera and the camera is “on”.
	Ready – When illuminated, the camera has booted-up and ready to connect to a host.

Teledyne Confidential; Commercially Sensitive Business Data

G620a & A6301 Camera's User's Manual

WARNING – EAR Controlled Technology (EAR99)

	Ethernet – LED blinks indicating network connected and activity.
	Cold – When illuminated, indicates the detector has reached operational temperature and images are now valid.
	Fault – When illuminated, indicates the camera has detected a fault. Also tied to the Fault I/O on the Aux connector.

4.1.2 PoE Connector

The PoE connector is a X-coded Ethernet and Power over Ethernet (PoE) connector. An ethernet connection is required for camera operations. The PoE injection is not required as the camera can be powered via PoE or the Auxiliary connector's power input pins.

If a PoE injector is used, a PoE+, Type 2, 30W supply is required.

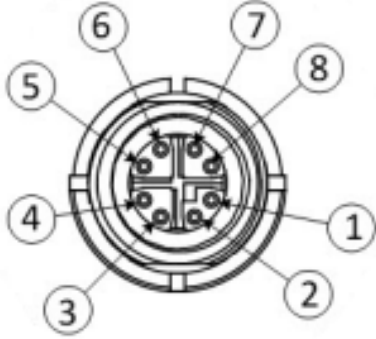
PoE Connector	Pin	Signal
	1	DA+
	2	DA-
	3	DB+
	4	DB-
	5	DD+
	6	DD-
	7	DC-
	8	DC+

4.1.3 AUX Connector

The AUX connector contains Digital I/O, Fault Indicator, External Sync, and optional power input.

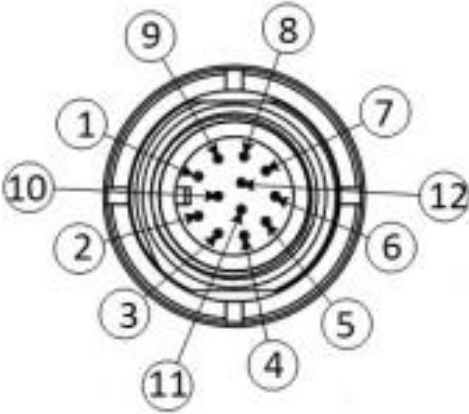
AUX Connector	Pin	Direction	Signal
	1	Input	- Aux Pwr
	2	Input	+ Aux Pwr (18-56V, 25W)
	3	See Figure 1	Fault A
	4	See Figure 1	Fault B
	5	See Figure 1	Dig Out 0, A
	6	See Figure 1	Dig Out 0, B
	7	See Figure 1	Dig Out 1, A
	8	See Figure 1	Dig Out 1, B
	9	Input	Dig in 0, 24V (isolated)
	10	Input	Dig in 1, 24V (isolated)
	11	Input	External Sync, 24V (isolated)
	12	Input	GND (isolated)

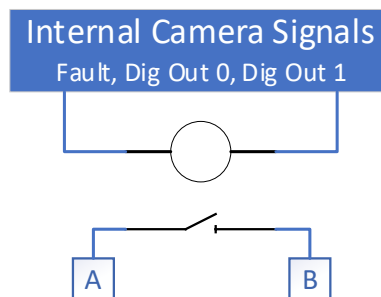



Figure 1: Logical Function of Output A and B Pins

4.1.3.1 AUX Pigtail Cable, T911852ACC

The T911852ACC is a pigtail cable that can be purchased separately for use with the camera's AUX connector.

T911852-B Pigtail Connector	Pin	Wire Color	Signal
	1	Black	- Aux Pwr
	2	Red	+ Aux Pwr (18-56V, 25W)
	3	Green	Fault A
	4	Purple	Fault B
	5	Yellow	Dig Out 0, A
	6	Pink	Dig Out 0, B
	7	Orange	Dig Out 1, A
	8	Brown	Dig Out 1, B
	9	White	Dig in 0, 24V (isolated)
	10	Gray	Dig in 1, 24V (isolated)
	11	Light Blue	External Sync, 24V (isolated)
	12	Blue	GND (isolated)

4.1.4 Factory Reset Button

Pressing, and holding, the Factory Reset Button on the rear panel performs the following functions:

Hold Button for	Results
Less than 1 second	Nothing
Greater than 1 second but less than 4 seconds	Reboot – Reboots the camera and returns to its last saved settings
Greater than 4 seconds but less than 10 seconds	Partial Reset – Resets the camera settings to its factory default settings, but preserves the IP configurations
Greater than 10 seconds	Full Reset – Resets the camera to its factory default settings, including all IP configurations

5 Connecting to the Camera for the First Time

Step 1 – Connect the camera to the host computer using an ethernet cable.

Use a PoE Injector (PoE+, Type 2, 30W) to power the camera. If powering the camera via the external power supply input on the AUX connect instead, refer to Section 0 for pin-outs.

Use the supplied M12 X-code RJ45F adapter cable if using a standard ethernet cable.

Step 2 – Wait for the Ready LED to illuminate.

Step 3 – Open a Web Browser and enter the camera's IP address in the Address Bar

See Section 5.3 for the default settings including IP address and Hostname.

Optionally, instead of using the camera's IP address, <Hostname>.local can be used

If you do not know the IP address or Hostname, or if they do not work, use Camera IP Config to get the camera's IP address (see Section 5.2)

Step 4 – Log-In

When logging in for the first time, the user will be prompted to enter a new username and password. See Section 5.3 for the default.

If the username and/or password do not work, then you may need to perform a Hard Reset of the camera. See Section 5.1.

Step 5 – Configure the camera's IP settings for your network

Refer to Section 8.6.

5.1 *Forgot Username/Password*

If you have forgotten your username and/or password, reset the camera by holding the rear panel reset button for more than 10 seconds (see Section 0)

5.2 *Forgot IP Address and/or Incorrect IP Settings*

If you do not know the camera's IP Address, or if the address is incompatible with your current network, you can use FLIR IP Config (see Section 9.1) to get an IP address that can be used to connect with. Then use the Web Browser to change the camera's IP settings.

5.3 Default Network Configuration

Field	Default Value
Settings	Static
IP Address	192.168.0.250
Host Name	<family>-<serial number> <ul style="list-style-type: none">• Examples:<ul style="list-style-type: none">○ G620a-G1001○ A6301-A10001• Model and Serial Number can be found on the camera's rear panel
Login	User Name = admin Password = admin
Firewall	Disabled

6 Camera Theory of Operation

6.1 Basic Camera Components

The figure below shows the basic parts of the camera regardless of camera family or model.

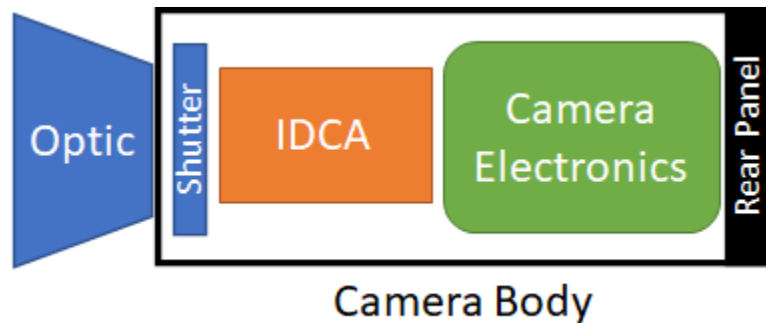

The G620a and A6301 camera families are defined by the IDCA, while the optics define the model within the camera family.

Camera Optics

The G620a family of cameras use a motorized optic allowing for autofocus and a software command of focus points. The A6301 family of cameras use a manual focused optic.

Within each camera family there are a variety of optics available with different Field of Views (FOV). The actual optic used is what defines a camera's model. While the optics are removable and different optics could be attached to a camera, this is not advisable. Each camera is calibrated at the factory to its specific optic. Changing optics will degrade the camera's image and temperature measurements will be invalid.

Shutter

The camera has an internal shutter, also called a flag or NUC flag, that is used to perform periodic corrections to the image.

As the camera changes temperatures the electronics yield slightly different results which creates slight imperfections in the image. The shutter is considered a flat field and when moved into the camera's FOV it provides a uniform temperature image across the camera's entire sensor array allowing a Flat Field Correction (FFC) routine to identify and correct those slight changes in the image.

IDCA

The Integrated Detector Cooler Assembly (IDCA) is where the magic happens in converting thermal energy into a voltage on a pixel-by-pixel basis. It consists of a Cold Filter (optional), FPA, ROIC, and cooler.

The Focal Plane Array (FPA) is an array of detector material that responds to incoming IR radiation. The FPA's base spectrum response depends on what material is used. Both the G620a and A6301 use a detector material called T2SLS and have a base bandwidth of 3.0 μ m to 5.0 μ m. The G620a

Teledyne Confidential; Commercially Sensitive Business Data

G620a & A6301 Camera's User's Manual

WARNING – EAR Controlled Technology (EAR99)

also contains a Cold Filter in front of the FPA which limits the spectrum response to $3.2\mu\text{m}$ to $3.4\mu\text{m}$ so that it can be optimized to energy emitted by gas.

The $3.0\mu\text{m}$ to $5.0\mu\text{m}$ range places these cameras in the Mid Wave IR portion of the overall energy spectrum, and as such, these cameras are often described as MWIR cameras; as opposed to Long Wave IR (LWIR) and Short Wave IR (SWIR).

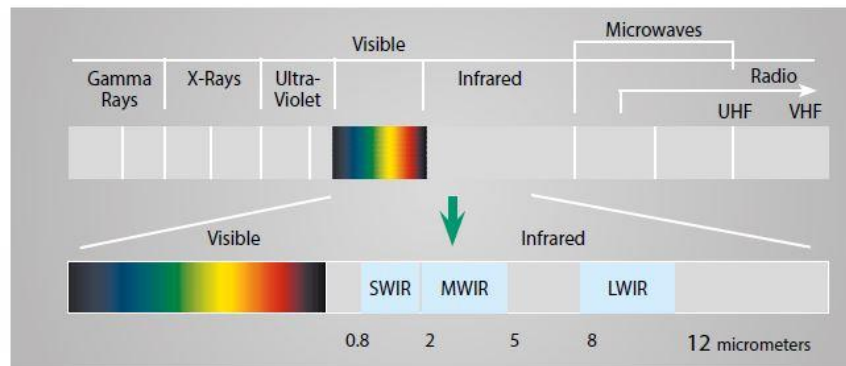

The FPA is mounted to a Read Out Integrated Circuit (ROIC) which effectively reads the FPA and produces a voltage corresponding to the IR energy input for each pixel of the FPA.

The Cold Filter, FPA, and ROIC are contained in a closed cycle cooler which keeps the temperature of the components around 150K (-123°C). This cold environment is what makes these type of IR cameras known as “cooled cameras”. Traditionally, the FPA material used in cooled IR cameras required an operation temperature of 77k (-196°C). But recent advancement in FPA material allows the operational temperature to be increased to 150K and has given rise to the term “HOT”. The High Operational Temperature (HOT) requires less work on the cooler itself, resulting in longer cooler/camera life for these HOT-MWIR cameras.

The G620a uses a Cold Filter to limit the spectrum range. The “cold” in Cold Filter refers to the filter’s location, which is inside the IDCA and thus cold. This is the most effective location for IR optic filters, however, they come at a cost of not being removable. In contrast, Warm Filters are basically the same optical filter but located outside the IDCA between it and the lens.

Camera Electronics

The camera electronics implement all the command and control to and from the user (or host). It also contains the data processing pipeline that converts the ROIC output to meaningful data for the user and creates a usable image for display.

6.2 Simplified Image Data Processing Pipeline

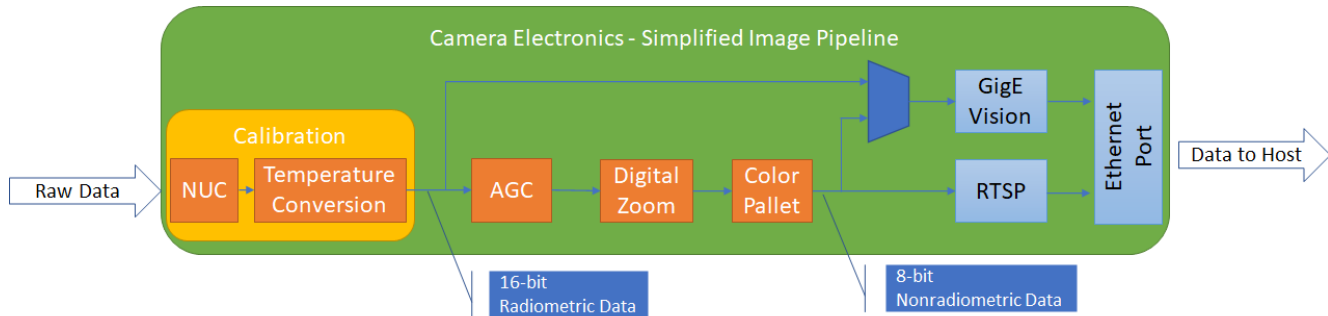

6.2.1 Calibration

Calibration is a two-part process in the image data processing pipeline consisting of applying a Non-Uniformity Correction (NUC) and a Temperature Conversion. Both of which consist of a series of algorithms with variables that are unique to every camera. These variables are determined during camera production through a procedure known as Factory Calibration and then stored on the camera.

Every camera has up to four calibration subranges that are subsets of the overall camera temperature range. While these ranges will differ between camera families and models, specific camera models all have the same ranges.

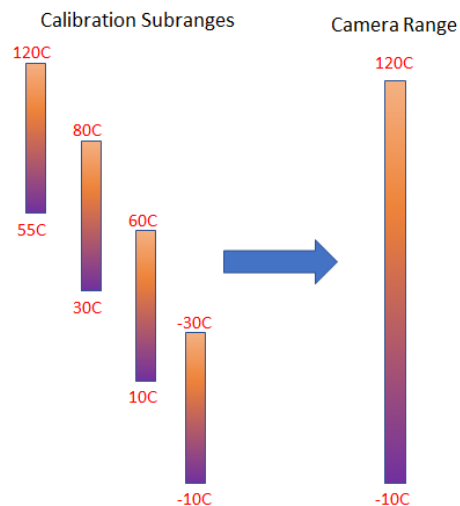

Each Calibration Subrange has an exposure time, also called integration time, associated with it. This is the amount of time the sensor is exposed to collect energy for a given frame of data.

The exposure time is a factor in setting the camera's max frame rate for a selected calibration subrange as the frame period ($1/\text{Frame Rate}$) cannot be less than the integration time. However, the camera can be set to run at lower frame rates if so desired.

6.2.1.1 Non-Uniformity Correction (NUC)

Simply stated, each pixel in an IR camera has its own circuitry associated with it and therefore reacts independently from the other pixels in the array. While the pixels respond linearly, the individual circuitry results in each pixel having its own unique slope and offset component typical in a linear system which vary slightly compared to the other pixels in the array. This means, given a constant energy input, every pixel will give a slightly different “answer”, resulting in a less than desirable looking image and an overall data array of values that is hard to interpret.

During the factory calibration process the slope and offset of every pixel is computed and a table of correcting gains and offsets for each pixel is created. When applied, this corrects each pixel’s unique slope and offset to a common slope and offset for the entire pixel array. The results are the same output for every pixel for any given energy input.

This process is called a Non-Uniformity Correction and is typically referred to with its acronym, NUC (pronounced “nuke”). The pixel data prior to the correction being applied is referred to as uncorrected or raw data. Once applied, the data is referred to as corrected or NUCed data (pronounced “nuked”).

The two images below show the difference between uncorrected (left) and corrected (right) data.

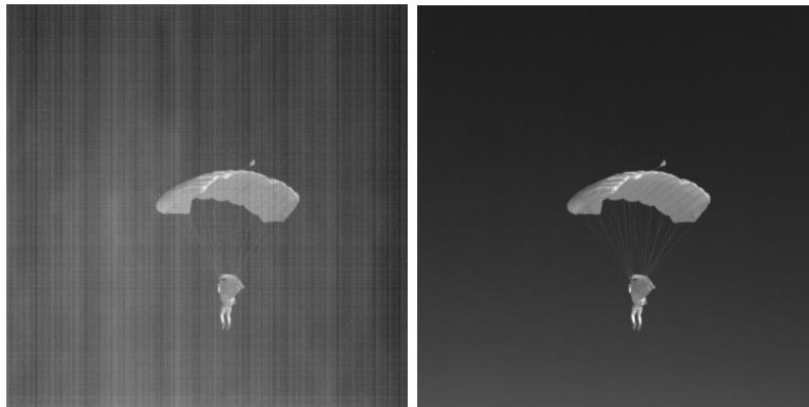

Figure 2 – Uncorrected Image (left) vs Corrected, or NUCed, Image (right)

6.2.1.2 Flat Field Correction

Each pixel’s offset component will change slightly as the camera’s electronics change temperature based on environmental conditions and run time. This causes a slight degradation in image quality. To correct for this, the camera can perform a Flat Field Correction (FFC) to which finds and correct these slight changes.

A Flat Field Correction is performed by first filling the camera’s FOV with a uniform image (flat field) and then running the FFC algorithm. The best results are achieved using a flat field external to the camera so that imperfections caused by the lens can be corrected as well. However, an external flat field can be very difficult to provide so the camera’s internal shutter can be used and still provide very good results.

The FFC will result in a slightly modified NUC table, but those modification are not saved in the table between power cycles as it is based on typical run time changes.

6.2.1.3 Bad Pixel Replacement

The final part of the NUC correction is a Bad Pixel Replacement. As the NUC table is created, pixels that do not correctly behave such that they can be brought into alignment with the other pixels are identified and marked as “bad”. When the NUC correction is applied, those bad pixels are replaced with a neighboring good pixel.

6.2.1.4 Temperature Conversion

The temperature conversion consists of mapping the pixel’s output values to the resulting temperature input. Prior to the temperature conversion, the pixel data is unitless and typically expressed in counts; often referred to as Digital Value or DV. Unlike the NUC, the count to temperature conversion is not linear but rather a multi-order polynomial equation.

The user may choose to turn the Temperature Conversion process off and instead perform that process on the host side. In which case the camera will pass data out in the form of unitless counts.

The data at this point in the processing is considered Radiometric data because temperature is able to be computed from it.

6.2.2 AGC

Automatic Gain Control (AGC) refers to the algorithm used to convert the 16-bit (0→65535) radiometric data into 8-bits (0→255) for display on a monitor. The use of the term “gain” in AGC can be a bit misleading as IR scaling algorithms are either linear using both a gain and offset component, or non-linear which is more typically used. The user can select a Linear scaling AGC or the non-linear Plateau Equalization (PE) algorithm.

To better understand the AGC algorithms, first consider what a typical scene looks like to an IR camera. If you create a histogram of the pixel values in a scene you will find that data appears in small clusters verses evenly distributed across the camera’s calibration range, with the largest cluster typically centered around the scene’s ambient temperature.

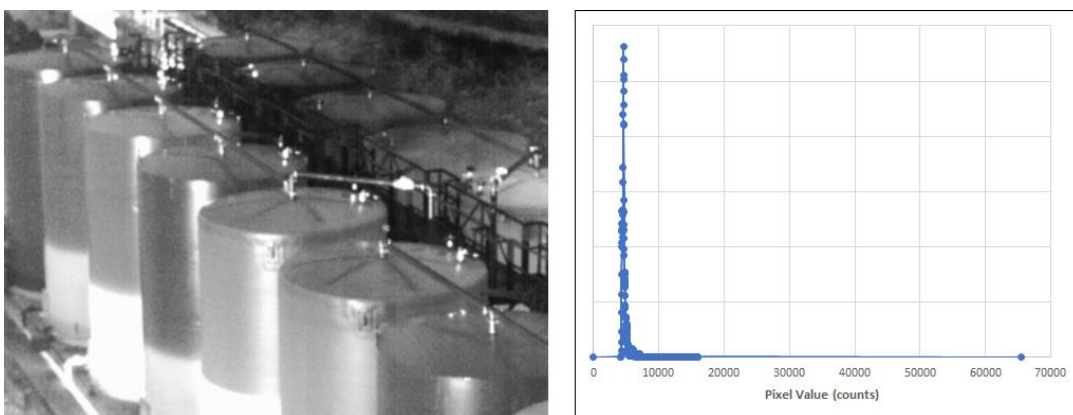

Figure 3 – IR Image (left) and it’s Histogram (right)

Teledyne Confidential; Commercially Sensitive Business Data

G620a & A6301 Camera’s User’s Manual

WARNING – EAR Controlled Technology (EAR99)

6.2.2.1 Linear AGC

The simplest method to scale the 16-bit data down to 8-bits is by dividing each value by 256, as shown in Figure 4. This greatly reduces the resolution of the display and results in the 8-bit data covering large areas of the temperate range that are not being used by the image. As you can see from the histogram (left), most data points in the image are mapped to only a few 8-bit points. Most of the 8-bit values are mapped to unused data points. The resulting image does not have enough different data values to display anything but a blank image.

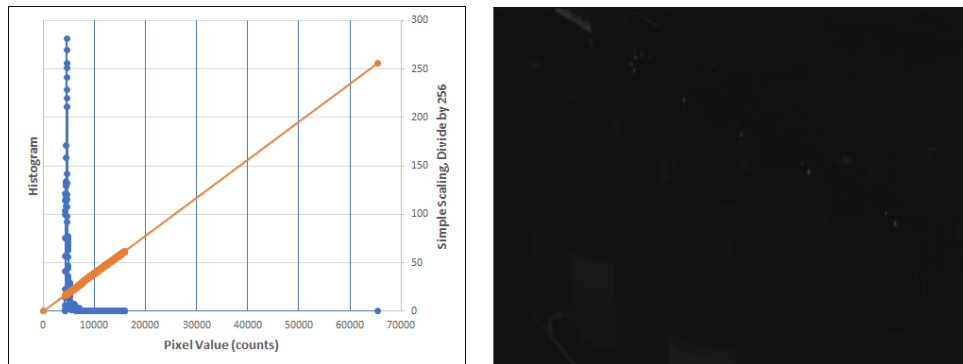

Figure 4 – Simple Gain Scaling

By adjusting the level and span (gain and offset) of the 8-bit output to match the image cluster, see Figure 5, image details can be seen as the entire 8-bit output will cover only the portion of the data being used.

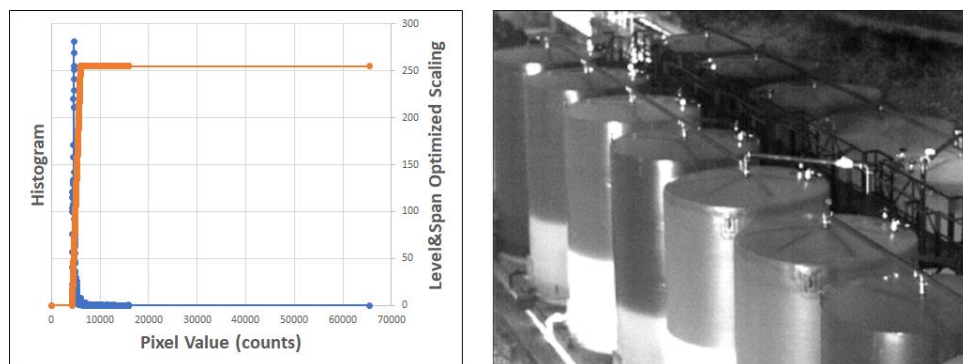

Figure 5 – Level & Span Optimized

6.2.2.2 Plateau Equalization (PE)

With a single cluster in the histogram the linear scaling works well. However, for multiple clusters that are spread apart, the linear scaling starts to break down as the level and span required become wide to cover all the clusters. See Figure 6, a soldering iron with a room temperature ambient background, as an example. Since the two clusters in the histogram are very narrow but spaced far apart, the resulting 8-bit data from a linear scaling only has a few data points mapped to actual scene's pixel values, with the overwhelming majoring of the 8-bit data mapping to unused values.

Teledyne Confidential; Commercially Sensitive Business Data

G620a & A6301 Camera's User's Manual

WARNING – EAR Controlled Technology (EAR99)

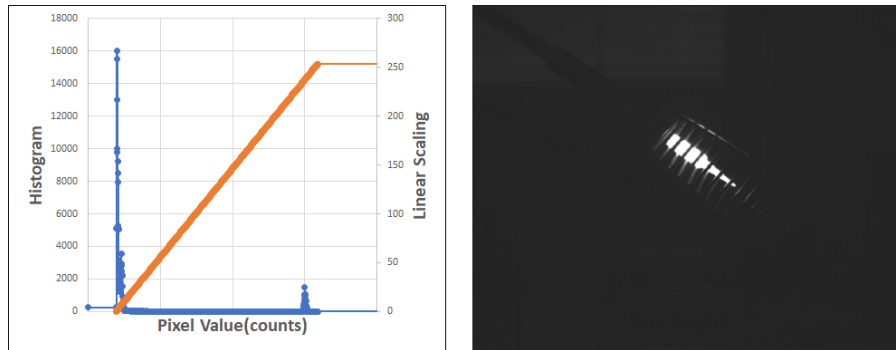

Figure 6 – Linear Scaling of a Soldering Iron

Plateau Equalization (PE) is a non-linear scaling algorithm that basically takes the top 256 peaks in the histogram and maps them to the 8-bit data output. This ensures that the mapping maximizes over where the data is changing and ignores unused data values, as shown in Figure 7.

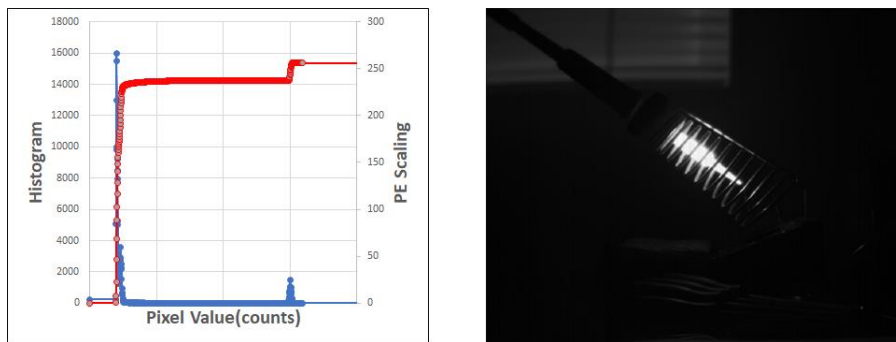

Figure 7 - PE Scaling of a Soldering Iron

More detail of the entire scene can be made out from the PE scaled images versus the Linearly scaled image.

6.2.2.3 AGC ROI

Often times the image contains a scene which has an object that is far hotter or colder than the object of what is desired to look at. This forces the AGC to use some of the 8-bits to cover the hot/cold object and therefore the resolution over the desired items is limited. In the case of the soldering iron images previously shown, if one was primarily interested in the ambient scene behind the soldering iron, very little detail can be determined because of the hot iron's influence over the final AGC scaling.

To overcome this issue, an AGC Region Of Interest (ROI) can be used to indicate to the camera which portion of the image to use for the AGC algorithm, versus using the entire image.

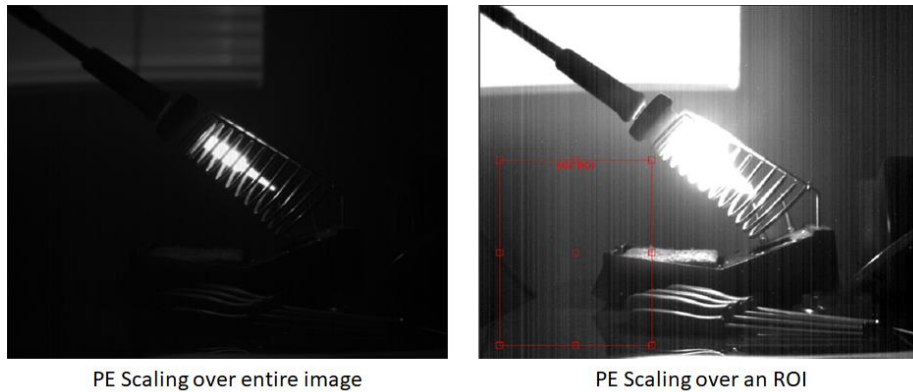

Figure 8 – PE Scaling Over Entire Images vs ROI

From Figure 8, in the left image the soldering iron forces the PE scaling to cover a wider range and therefore little contrast can be seen in the background. The right image uses an AGC ROI that excludes the soldering iron. While the soldering iron is now scaled to saturation, the items in the background have more scaling resolution and become discernable.

6.2.2.4 AGC Filter

The AGC is performed on every frame of data. This means if something very hot, or very cold, moves into the image the scaling will create a huge “jump” in data output that can be undesirable. To help counter this effect, an AGC Filter softens how much the AGC scaling changes from frame to frame.

6.2.2.5 AGC Lock

Often it is not enough to simply soften the AGC output from frame to frame. For example, if wanting to see a difference in the scene from frame to frame, the AGC itself will cause the digital values to change even with an aggressive filter. When enabled, the AGC Lock will cause the updating of the AGC values to freeze. This gives the user an AGC scaled image but one that is not constantly changing.

6.2.3 Digital Zoom

The Digital Zoom simply zooms into the center of the image by the user selected scale. For example, if the user chooses x4 zoom, the camera takes the center 160x128 pixels and scales it up to 640x512.

6.2.4 Color Pallet

While we think of hot as being red and cold as being blue, IR energy has no color. To display an image of IR energy the camera must apply a Color Pallet, also known as a False Color Pallet, to the array of digital values.

The camera uses 8-bit Color Pallets which contain 256 individual colors and applies this pallet to the AGC scaled, 8-bit data. The grayscale pallet is the most used pallet as it ranges from black to white and typically yields the best contrast. However, there are numerous pallets for the user to choose from that best fits the user’s application.

6.2.5 Radiometric vs Nonradiometric Data

Radiometric Data is an array of 16-bit values that have meaning and can be used for measurements. The data has been corrected, or NUCed, and may or may not have been converted to temperatures (some users prefer to perform the Temperature Conversion on the host side). However, it cannot be effectively displayed in an image.

Nonradiometric Data has had the AGC Scaling, Digital Zoom, and Color Pallet applied. It is 8-bit data that is meant for display purposes. Very little information is contained in the values themselves and thus has limited use in actual measurements. Nonradiometric Data is primarily intended for display and thus would be considered imaging data.

6.2.6 RTSP

Real Time Streaming Protocol, RTSP, is a standard network protocol for streaming video. The camera can stream H.264 or MPEG compressed, nonradiometric data using RTSP.

6.2.7 GigE Vision

GigE Vision is an industry standard protocol for industrial cameras that can pass uncompress, radiometric, 16-bit data over ethernet networks.

6.3 Autofocus (G620a)

The G620a cameras contain a motorized lens which allows it to have an Autofocus function. Autofocus is passive in nature in that it determines the optimum focus position based on the image it receives. It works by moving the focus position across its length of travel and analyzing the amount of contrast in the image for each position. The focus position yielding the greatest amount of contrast is considered the optimum focus position.

6.3.1 Autofocus ROI

A scene typically contains multiple “things” at different distances from the camera. Therefore, the camera doesn’t necessarily know which “thing” to focus on when performing an Autofocus. The user can adjust the Zoom Region of Interest, Zoom ROI, to cover the actual item the user wishes to focus on. This tells the camera what portion of the image to use for the autofocus algorithm.

6.4 Frame Latency

Frame Latency is defined here as the latency in syncs between when an image is “taken” and when the resulting data is passed out of the camera. As such, it’s only relevant when the camera is using an External Sync. It’s also only valid when acquiring images from the camera using GigE Vision as RTSP is non-deterministic with regards to image buffering.

6.4.1 Frame Latency and the A6301

A common use case for an automation camera is for a user to want a single snapshot at a precise point in time, such as taking a picture of a widget on an assembly line. The user would feed the camera an external sync, such as a TTL signal from a position switch on the assembly line, and expect the camera to take a picture, or start integration, when that signal goes active.

To do this, the A6301 cameras operate in what's called Frame Sync Starts Integration (FSSI). This means the camera takes a picture (starts integration) immediately when it receives a sync giving the user precise timing on the event they wish to capture. Once the integration is complete, the image is read off the sensor and placed into a buffer inside the camera. The next sync that occurs the image will be passed from that buffer to the user. Therefore, there is a one sync delay in the image on the A6301 cameras.

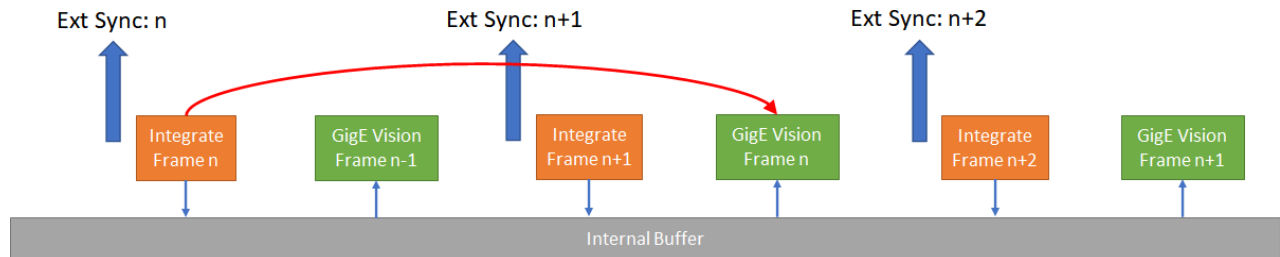

Figure 9: A6301 Ext Sync, One Frame Latency for Data Output

6.4.2 Frame Latency and the G620a

Although available, the use cases of the OGI G620a cameras do not typically include operating the camera in External Sync mode. The G620a is not intended to take a single snapshot at a precise moment in time, but rather free run at a given frame rate where the frame latency is not a factor. If the user does operate the G620a in External Sync mode, the camera's internal buffering will result in a two (2) sync latency.

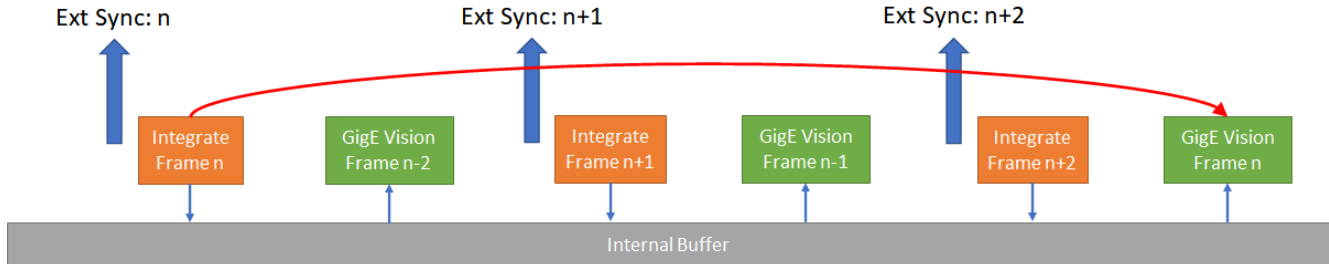

Figure 10: G620a Ext Sync, Two Frame Latency for Data Output

7 Operating the Camera

The camera has two distinct paths for imaging, control, and user GUI/display. Which path to use typically depends on whether the user is interested in Radiometric or Nonradiometric data.

7.1 *Non-Radiometric Data Users*

For users who are not interested in actual temperature measurements with the camera. This data is 8-bit, AGC scaled video data for imaging only.

- **GUI** – Web Browser
- **Data Streams** – RTSP
- **Custom Camera Control** – REST API

7.2 *Radiometric Data Users*

For users who require temperature data. This data is 16-bit with or without temperature conversion, with no AGC scaling applied.

- **GUI** – CamTools > Camera PlayIR
- **Data Streams** – GigE Vision
- **Custom Camera Control** – GeniCam

7.3 *Using the REST API*

The camera can be controlled with REST API. The camera's *.yaml file, which can be downloaded from the Web Browser's Help page, details all the communications available through the REST API. This file can be uploaded to a free viewer, like swagger.io (<https://editor.swagger.io/>), to see all the commands available for the camera.

7.4 *Accessing the RTSP Video Streams*

The two RTSP video streams can be configured from the Web Browser's Video Page, see Section 8.2. Once configured, the streams can be accessed via the below URLs.

- **Stream1**— rtsp://<cameraIP>/stream1
- **Stream2**— rtsp://<cameraIP>/stream2

By default, RTSP authentication is enabled. To access any of the camera's video streams, you can use the name and password for any of the camera's users. Users assigned the role of admin or expert can disable RTSP authentication via the Web Browsers Cyber Tab, Section 8.6.5.

7.4.1 Opening Stream in VLC

Figure 11 shows an example of opening Stream2 in VLC Media Player.

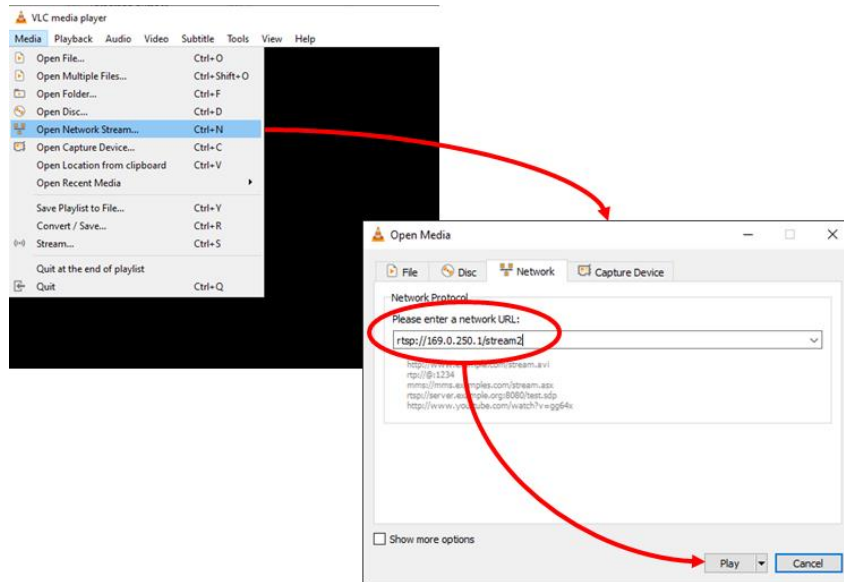

Figure 11 – Opening Stream 2 in VLC Example

8 Web Browser

This chapter contains information about how to control the camera using the Web Browser interface.

From the host computer, open a web browser (such as Google Chrome® which this guide reflects) and type the camera's IP address (or optionally the <Hostname>.local) in the browser's address bar. If you do not know the IP address, the DNA tool can be used to discover it. The camera's default configuration can be found in Section 5.1.

When the login screen appears, type the username and password and then press **Log In**. The default values are found in Section 5.1.

When logging in to the camera for the first time, or for the first time after resetting the camera to its factory defaults, you will be prompted to specify a new password for the admin user and then log back in using the new password.

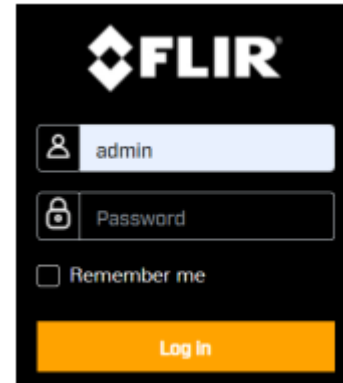

8.1 Home Page



After logging into the camera, the Home Page is displayed showing the camera's image in the center, control pages on the left, and the lens control on the right and bottom of the screen.

Live Video Refresh Rate – Sets the web browser image refresh rate, in Hz.

Lens Control

- **Far** – Steps the lens towards infinite focus.
- **Near** – Steps the lens towards the near focus point.
- **Auto** – Automatically focuses based on the scene contained in the **Focus ROI**
- **Show Focus ROI** – Overlays on the image the **Focus ROI**.

Teledyne Confidential; Commercially Sensitive Business Data

G620a & A6301 Camera's User's Manual

WARNING – EAR Controlled Technology (EAR99)

- **Slider Bar** – Moves the lens through its travel range.
- **Encoder Counts** – The focus position in encoder counts. Used for focus point reference so the focus position can be returned to a predetermined spot.

Digital Zoom – Selectable digital zoom of x1, x2, x4 or x8

V-Flip – Flips the image in the vertical direction.

H-Flip – Flips the image in the horizontal direction.

Focus ROI - The Focus ROI (region of interest) is the area of the image the camera uses to perform the autofocus routine. When **Show Focus ROI** is enabled, the Focus ROI appears in the live video on the camera web page. In video streams, the overlay does not appear. In most cases there are objects within the image that are various distances from the camera, so defining which object to focus on with the ROI is the best course of action.



Resize

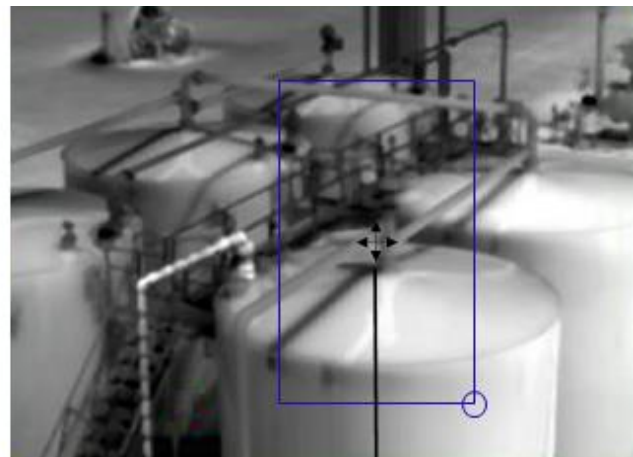

Move

- **To change the size of the ROI** - Hover over the handle in the bottom-right corner of the ROI and then click and drag it.
- **To move the entire ROI** - Hover over the center of the ROI, and then click and drag it.

8.2 Video Page

The Video Page contains the controls for the camera's two IP video streams (Stream1 and Stream2). In general, modifying the default IP video settings is not necessary. In some cases, such as when a stream is sent over a wireless network, fine-tuning the streams can help reduce the bandwidth requirements.

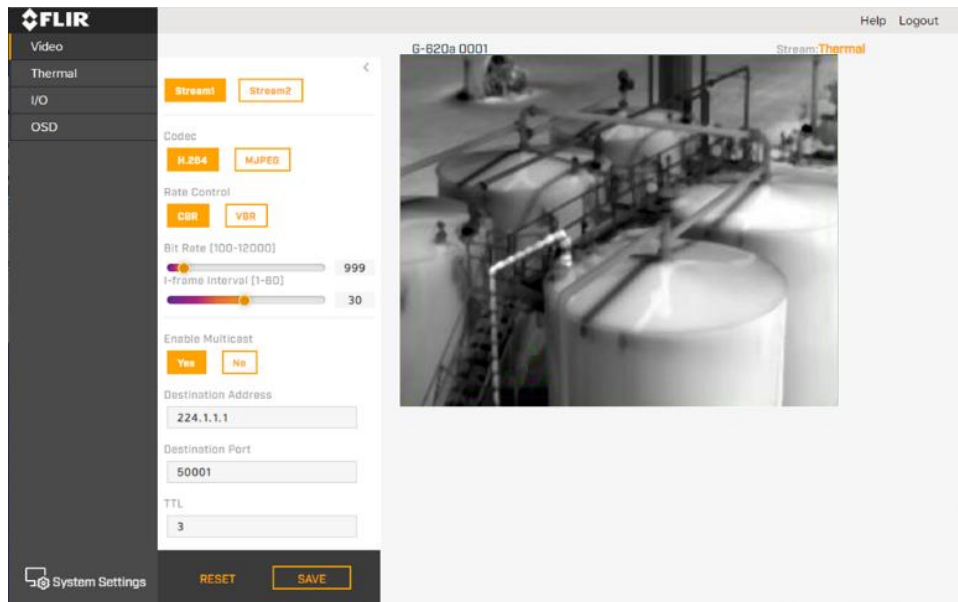

To change the settings for a particular video stream, click the relevant button (Stream1 or Stream2).

The stream resolution is fixed at 640x512 and the frame rate follows the camera's frame rate.

The codec determines which settings are available. The values of those settings can have a significant impact on the quality and bandwidth requirements of the video stream.

Any changes made to the Video Page must be saved to take effect.



Codec - H.264

With the H.264 codec, the following settings are available.

- **Rate Control**
 - **CBR** (constant bit rate)—The **Bit Rate** parameter defines the target bit rate; the camera attempts to keep the video at or near the target bit rate.
 - **VBR** (variable bit rate)—The **Bit Rate** parameter defines the average bit rate.
- **I-frame Interval**—Controls the number of P-frames used between I-frames. I-frames are full frames of video, and the P-frames contain the changes that occurred since the last I-frame. A smaller I-frame Interval results in higher bandwidth (more full frames sent) and better video quality. A higher I-frame Interval means fewer I-frames are sent and therefore can result in lower bandwidth and possibly lower quality.

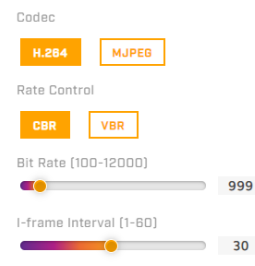

Codec - MJPEG

With the MJPEG codec, the **Quality** setting is available.

- **Quality** - can be set between 0-100. Setting a higher value can increase the video stream's bandwidth requirements. Teledyne FLIR recommends setting a value no higher than 80.

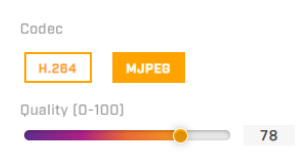

Enable Multicast

By default, multicast is enabled. Multicast video packets are shared by streaming clients. Additional clients do not cause bandwidth to increase as dramatically as with unicast. Video stream requests for Stream1 are unicast. Client-specific multicast requests vary according to the client.

If more than one camera is providing multicast streams on the network, make sure the **Destination Address** Network IP address is unique for each camera (the **Destination Port** can be reused). By default, the port assignment is unique per stream.

The **TTL** (time-to-live) field controls the ability of IP packets to traverse network boundaries. A value of 1 restricts the stream to the same subnet. Greater values allow increasing access between networks.

The video streaming uses a protocol generally referred to as RTP, the real-time transport protocol, although there are a number of protocols involved including the Real-Time Streaming Protocol (RTSP). The video stream URLs incorporate the IP address of the camera. Using the camera's default IP address, the complete URLs are:

- **Stream1**—rtsp://<cameraIP>/stream1
- **Stream2**—rtsp://<cameraIP>/stream2

By default, RTSP authentication is enabled. To access any of the camera's video streams, you can use the name and password for any of the camera's users. Users assigned the role of admin or expert can disable RTSP authentication, see section 8.6.5 Cyber Tab

8.3 Thermal Page

In most installations, changing the default settings of the thermal imager is not necessary. However, in some situations and depending on the scene, modifying one or more parameters can improve the image. Be aware that, when conditions change, you might need to adjust the parameters again.

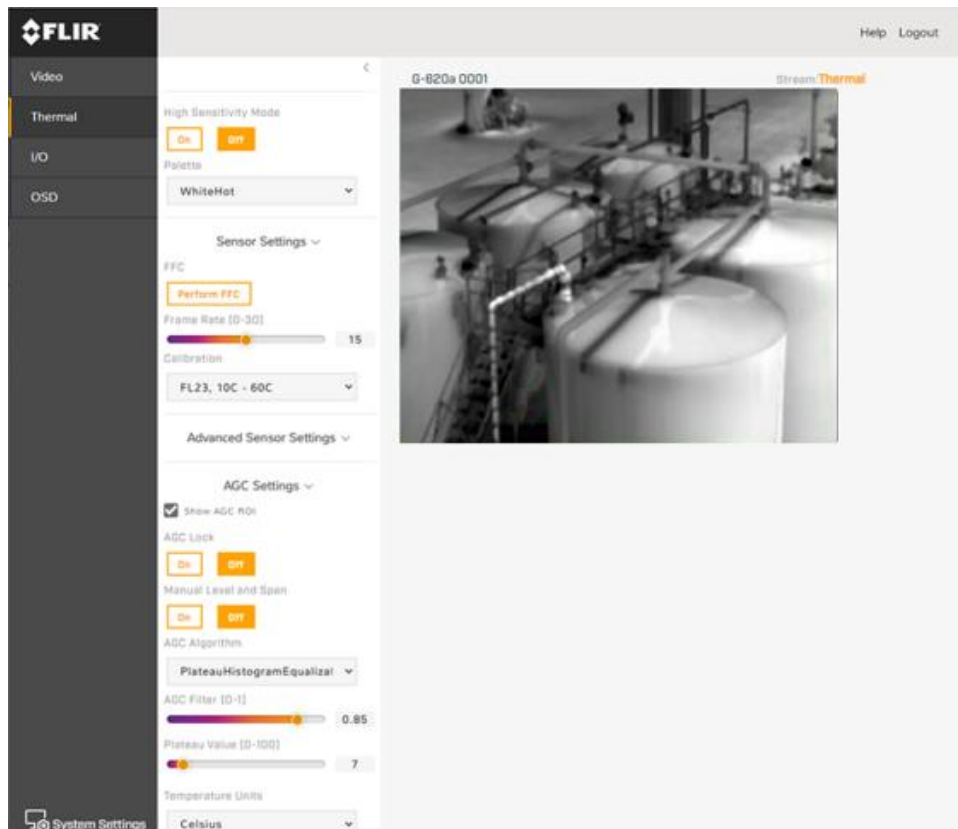

High Sensitivity Mode (HSM) - A FLIR-patented algorithm first introduced in the GasFindIR cameras that allows the user to see small temperature changes in the scene.

Palette - Select the color palette the camera uses to indicate detected levels of thermal energy. WhiteHot and BlackHot are gray-scale palettes; other palettes assign different colors to different temperatures.

Sensor Settings

- **FFC (Flat Field Correction)** - To manually trigger an FFC click **Perform FFC**. The shutter for the thermal imager closes and provides a target of uniform temperature allowing the thermal imager to correct for ambient temperature changes and provide the best possible image. During the FFC the image momentarily freezes. The camera can be configured to perform FFCs automatically at regular intervals or when the ambient temperature changes (**FFC Mode**).
- **Frame Rate** – Rate (Hz) the camera takes a new image.
- **Calibration** – Selects the temperature range to use.

Advanced Sensor Settings

- **FFC Mode** – Selects how and when the FFC is performed.
 - **Auto** – performs a FFC automatically based on the **Auto FFC When** criteria.
 - **Manual** – performs a FFC only when the **Perform FFC** button is selected, uses the internal flag.
 - **External** – performs a FFC only when the **Perform FFC** button is selected, does not use the internal flag. The user must fill the FOV with a uniform image before performing the FFC.
- **Auto FFC when** –
 - **FPA Temp Change** – performs an FFC when the temperature has changed by the set degrees. A setting of 0 disables FFCs based on temperature change.
 - **Periodically** – performs an FFC every x seconds. A setting of 0 disables periodic FFCs based on time.
- **Sync Mode** – Selects which sync source to use.
 - **Internal** – Uses the camera’s internal, free running sync that is user set by the Frame Rate control
 - **External** – Uses an external sync source via the rear panel AUX connector .

AGC Settings

- **Show AGC ROI** – Displays the AGC ROI on the web browser’s image.
- **AGC Lock** – Locks the AGC to the last computed values.
- **Manal Level and Span** – Manually control the Level and Span of the gain control.
- **AGC Algorithm**
 - **Linear** – Simple gain/offset method for scaling the 16-bit image data to 8-bit data for display.
 - **Plateau Histogram Equalization** – a non-linear algorithm which scales the 16-bit image data to 8-bit data for display.
- **AGC Filter** – Determines how quickly a scene adjusts when a hot object appears (or disappears) within the AGC ROI. If set to a low value, when a hot object enters the ROI the AGC will adjust more slowly to the hot object, resulting in a more gradual transition.
- **Temperature Units** – The temperature units displayed on the gain/offset slider bar.
- **Plateau Value** – Scaling factor for the **Plateau Histogram Equalization** algorithm.

AGC ROI - The AGC ROI (region of interest) is the portion of the image the AGC algorithm uses to compute the image scaling variables. When **Show AGC ROI** is enabled, the AGC ROI overlay appears in the live video on the camera’s web page. In video streams, the overlay does not appear. By default, the ROI is full screen; the AGC algorithm considers the entire image. In some cases, defining an ROI that excludes a portion of the screen can improve the scaling of the parts of the image that is of interest.

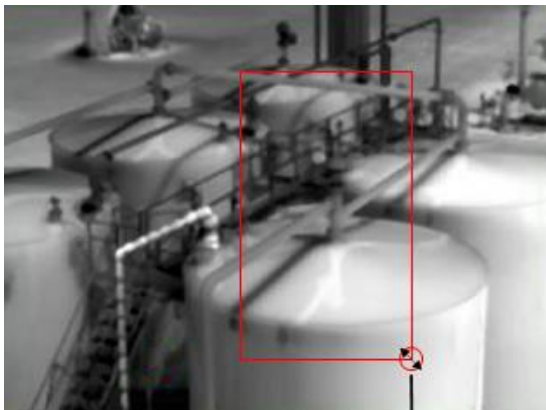

Resize



Move

- **To change the size of the ROI** - Hover over the handle in the bottom-right corner of the ROI and then click and drag it.
- **To move the entire ROI** - Hover over the ROI, and then click and drag it.

8.4 I/O Page

The I/O Page gives control over the Digital Input and Output pins on the camera's AUX connector, see Section 4.1.3

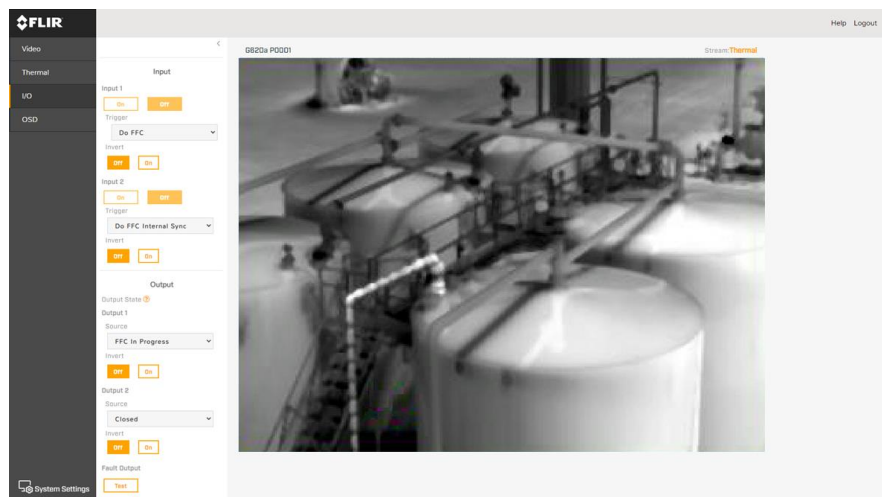

Digital Inputs

Input– Indicates whether the input pin is logic high (On) or logic low (Off).

Trigger – Selects what happens when the Input sees an active edge signal.

- **Off** – Nothing happens.

- **Do FFC** – Performs a Flat Field Correction, also known as an Update Offset. When running in External Sync mode, must provide a streaming set of syncs during the FFC process.
- **Do FFC Internal Sync** – Switches to the Internal Sync source first and then performs a Flat Field Correction (FFC). Use this when running the camera in External Sync but cannot provide a streaming set of syncs for the Update Offset process.

Invert – Selects which edge of the input signal to trigger from / what the steady state, active high level condition is

- **Disabled** – Uses the rising edge for trigger / “On” is a high input.
- **Enabled** – Uses the falling edge for trigger / “On” is a low input.

Digital Outputs – Both digital outputs correspond to a set of pins, A/B, on the rear panel AUX connector which act as a switch. When the output is “Open”, that means the pins are disconnected. When the output is “Closed” the pins are connected.

Source – Selects what the source is for the output.

- **Open** – The output switch is open; the A/B pins are not connected. Also called Off or False.
- **Closed** – the output switch is closed; the A/B pins are shorted together. Also called On or True.
- **Update Offset in Progress** – Closes to indicate when an Update Offset is in progress and the output images are not usable.

Invert – Inverts the output action.

Fault - Controls the Fault Output Pins (A/B), which acts as a switch closure.

The Output and Fault A/B pins are the contacts of a switch. When “open”, the A and B pins are not connected. When “closed”, the A and B pins are shorted together.

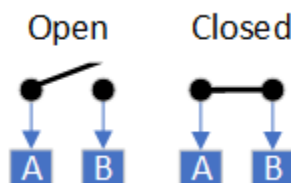
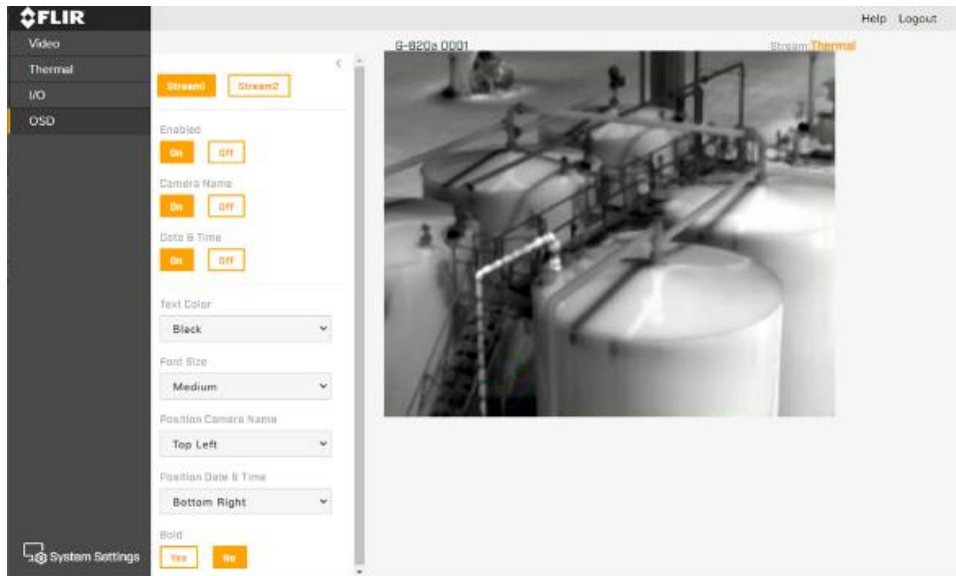

Figure 12 - Aux Connector Digital Out 0/1 and Fault Pins

8.5 OSD Page



For each IP video stream (stream1, stream2), an On-Screen Display (OSD) consisting of Camera Name and the Date & Time can be enabled and configured.

Enable – Turns the OSD for the selected stream on/off.

Camera Name – Turns the Camera Name on/off of the selected stream's OSD

Date & Time – Turns the camera's Date & Time on/off the selected stream's OSD

The Camera Name and Date & Time can be configured as following:

- **Text Color**—Black or white, with or without a background
- **Font Size**—Small, medium, big, or giant
- **Position**—Top or bottom; left, center, or right
- **Bold text**

When OSD is enabled for Stream1, the OSD appears in the live video on the camera's web page as well.

8.6 Camera System Settings

Users assigned the admin or expert role can click **System Settings** on the bottom left corner of the Home Page to access the following configuration pages:

- **Network**
- **Date & Time**
- **Users**
- **Temperature**
- **Cyber**
- **Firmware & Info**

8.6.1 Network Tab

The Network tab provides networking settings.

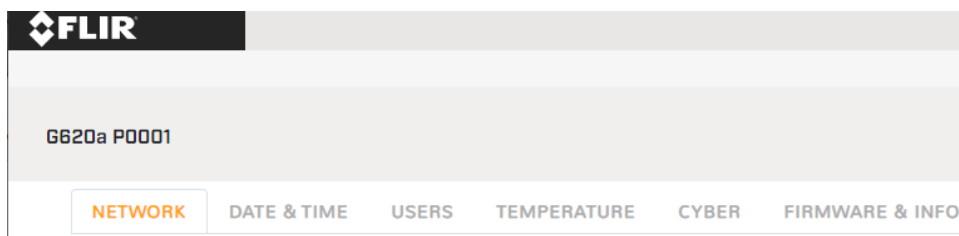

Warning

If you do not know how to configure these settings, contact your network administrator

The DHCP and Static buttons at the top of the page specify the IP addressing mode. If the IP addressing mode is set to DHCP but a DHCP server is not available on the network, the camera's IP address defaults to that listed in section 5.3 Default Network Configuration.



Caution

After changing the camera's IP address, the PC you are using to access the camera's web page may no longer be on the same network as the camera. As a result, the PC would no longer be able to access the camera's web page.

To access the camera web page again, change the PC's IP address to be on the same network as the camera

	DHCP	Static
Hostname Mode	Select DHCP or Static	Static only
Hostname		
IP		Camera's IP address
Netmask		Default value is 255.255.255.0
Gateway		The Hostname Mode can be set to <i>DHCP</i> or <i>Static</i> (default). If set to <i>Static</i> , specify the Hostname for the camera's server.
DNS Mode	Can be set to <i>DHCP</i> or <i>Static</i>	Mode will be <i>Static</i>
Name Server 1	When DNS Mode is set to <i>Static</i> , set the Name Server 1 to the primary domain name server that translates host names into IP addresses.	
Name Server 2	When DNS Mode is set to <i>Static</i> , set the Name Server 2 to the secondary domain name server that backs up the primary DNS	
MTU	Maximum transmission unit, the largest amount of data that can be transferred in one physical frame on the network. For Ethernet, the MTU is 1500 bytes (the default setting). For PPPoE, the MTU is 1492. Valid values are 1000-1500	
Ethernet Speed	When set to 100Mbps (default), the camera supports 100Mbps. When set to Auto, the camera supports 100/1000 Mbps.	

8.6.2 Date & Time Tab

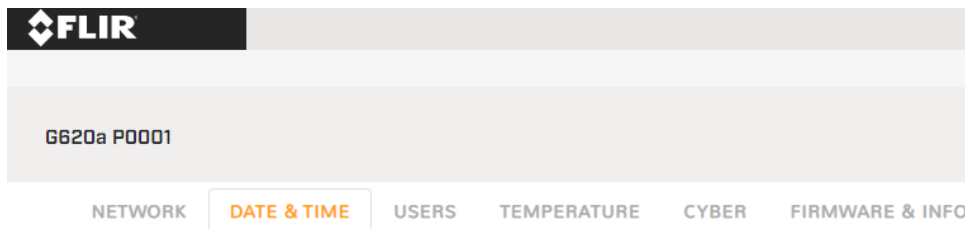

The camera's date and time can be synchronized with a NTP server, or it can utilize its own internal battery backup Real Time Clock (RTC) which can be manually set by the user and retain its time while the camera is turned off.

Network Time Protocol (NTP) - When DHCP IP addressing is enabled on the Settings Tab, the camera can be configured to obtain the NTP server information from the DHCP server.

The **Time Zone** and **Daylight Savings** selections are still required as NTP does not support these settings.

When the **NTP Server** is set to DCHP, the server is found automatically. To manually specify one or more NTP server addresses, under **NTP Sever** click Manual and specify the address(es). Use a comma to separate addresses.

If the camera is unable to connect to an NTP server, it will default to its internal RTC.

Manual - When Manual is selected the camera gets its time internally from an RTC. The **Time Zone**, **Daylight Saving**, **Time**, and **Date** would need to be set by the user.

8.6.3 User's Tab

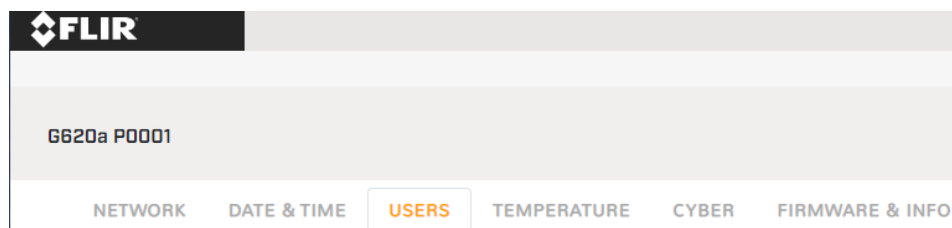

Users can be created, deleted, edited, and passwords changed or set via the **Users Tab** by users assigned the admin role.







Users assigned the expert role only see the user currently logged in, and cannot add, edit, or delete a user.

To maintain security of the system, set up usernames and passwords for each required login account.

The camera limits username length to 29 characters. Passwords must be at least 12 characters; must contain at least one number, one lowercase letter, and one uppercase letter; and can include the following special characters: |@#~!\$&<>+_-.,*?= .

Assign one of the following roles, according to the level of access the user requires:

user	expert	admin
<ul style="list-style-type: none"> View Live Video View Help Page Log out 	Access and use all pages, menus, controls, and settings except the Users Tab	Access and use all pages, menus, controls, and settings, including the Users Tab (cannot delete the default admin user)
<p>When the camera's video streams require RTSP authentication, accessing the camera's video streams requires the name and password for any camera user. All roles provide access to the camera's video streams.</p>		

User Name	Role	Actions
admin	admin	 
JohnDoe	user	  Delete User
JaneDoe	expert	 

ADD USER — **Add User** **Edit User**

Add User x

User

Password

Confirm password

Role

Edit User x

User

Password

Confirm password

Empty fields will keep the current password

Role

To keep the existing password, leave the password fields empty.

8.6.4 Temperature Tab

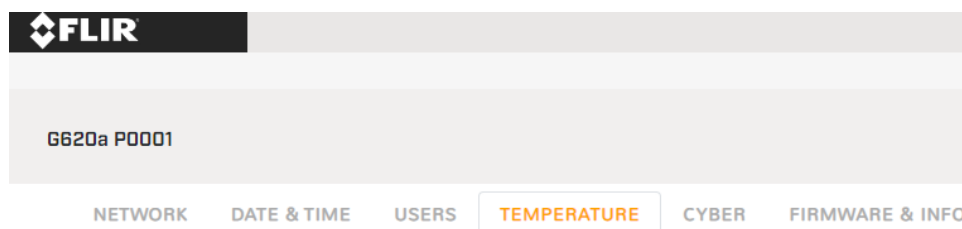

Various thermometers are placed inside the camera and the readings are displayed on the Temperature Tab. This gives the user an idea of the camera's temperature and indicates if the camera is overheating or has overheated.

8.6.5 Cyber Tab

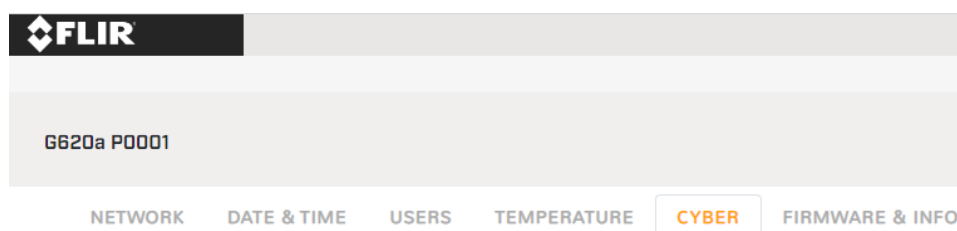

The Cyber page provides security configurations settings for:

- Certificates
- 802.1X
- TLS/HTTPS
- Services
- IP Filter

If you do not know how to configure these settings, contact your network administrator.

8.6.5.1 Certificates

Before you can enable TLS/HTTPS or 802.1X, you need to generate or upload a valid certificate. You can use the camera's web page to generate a self-signed certificate; upload a self-signed certificate; or upload a certificate signed by a third-party. If you do not know how to configure these settings, contact your network administrator.

Certificates and keys must be in PEM format. Common file extensions for TLS files in PEM format are:

- **For certificate and public key files:** *.crt, *.cer, *.cert, *.pem
- **For private key files:** *.key

From the Certificates section of the Cyber page, you can download certificates and keys previously uploaded to or generated by the camera. If the certificate saved on the camera is self-signed, you can download the private and public key files. If the certificate was signed by a third-party CA, you can download the CA Certificate and the private and public key files.

Teledyne Confidential; Commercially Sensitive Business Data

G620a & A6301 Camera's User's Manual

WARNING – EAR Controlled Technology (EAR99)

8.6.5.1.1 To generate and install a self-signed certificate for TLS/HTTPS

Certification Area
 TLS/HTTPS 802.1X

Self-Signed Upload Certificate

Country Code Province Name

City Name Common Name

Organization Name Organization Unit Name

Email Address Expiration Time (months)

1. In the Certificates section and Certification area, select **TLS/HTTPS** and **Self-Signed**.
2. Enter information such as country code, city name, and organization name.
3. Click **Create Certificate**.
4. Allow 15 seconds for the camera to generate the certificate, at which point a confirmation appears.

8.6.5.1.2 To upload a self-signed or third-party CA signed certificate for TLS/HTTPS or for 802.1X

Certification Area
 TLS/HTTPS 802.1X

Self-Signed Upload Certificate

Public Key (PEM format: *.crt, *.cer, *.cert, *.pem) Private Key (*.key)

CA Certificate (PEM format: *.crt, *.cer, *.cert, *.pem)

To Upload a Certificate for TLS/HTTPS

Certification Area
 TLS/HTTPS 802.1X

Public Key (PEM format: *.crt, *.cer, *.cert, *.pem) Private Key (*.key)

CA Certificate (PEM format: *.crt, *.cer, *.cert, *.pem)

To Upload a Certificate for 802.1X

1. In the Certification area, click **TLS/HTTPS** and then select **Upload Certificates**, or click **802.1X**.
2. If you are uploading a self-signed certificate, under **Public Key** and then under **Private Key**:
 - a. Click **Upload File**

Teledyne Confidential; Commercially Sensitive Business Data

G620a & A6301 Camera's User's Manual

WARNING – EAR Controlled Technology (EAR99)

- b. Select the appropriate key file.
 - c. Click **Upload File**.
3. If you are uploading a third-party CA signed certificate, select and upload the Public Key, Private Key, and CA Certificate.
4. Verify that the camera certificate files are valid and make sure *Certificates are OK* appears under the certificate information, under Download certificate.

8.6.5.1.3 To download keys and certificates from the camera:

Download Certificates

Common Name
Organization Name

Issuer

Country
Locality

Validity Period (From-To)
From
To

PUBLIC KEY PRIVATE KEY CA CERT

Download Certificates

PUBLIC KEY PRIVATE KEY CA CERT

To Upload a Key or Certificate for 802.1X

To Upload a Key or Certificate for TLS/HTTPS

1. Select TLS/HTTPS or 802.1X
2. Select item you want to download Public Key, Private Key or CA Cert

8.6.5.2 802.1X

Enable Disable

EAP Method

TLS PEAP

Identity Private Key Password

You can enable or disable IEEE 802.1X-compliant TLS communication by providing the Identity and the Private Key Password. The default is disabled.

If you do not know how to configure these settings, contact your network administrator.

8.6.5.3 TLS/HTTPS

Control

On Off

HTTP Redirect

On Off

You can enable or disable:

- Camera control using Transport Layer Security (TLS) / secure HTTP (HTTPS)
- HTTPS redirect

For both, the default is disabled.

If you do not know how to configure these settings, contact your network administrator.

8.6.5.4 Services

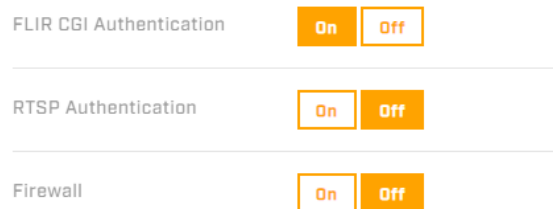

You can enable or disable:

- Digest authentication for the FLIR CGI control interface. Default is On (enabled).
- RTSP authentication. When disabled, accessing the camera's video streams does not require authentication. Default is On (enabled).
- Firewall (see section 8.6.5.5 Firewall Settings). Default is Off (disabled).

8.6.5.5 Firewall Settings

Services	Allow/Block
RTSP	Allow Block
UPNP	Allow Block
Nexus Discovery	Allow Block
Nexus SDK	Allow Block
TRK	Allow Block
ICMP	Allow Block
SNMP	Allow Block
GigE Vision	Allow Block

For enhanced security, the camera has a firewall that is disabled by default. You can enable it by clicking On. The image above shows the default setting for each service.

To disable a service and its default port, click Block. To enable a service, click Allow.



Caution

Disabling services and ports can affect product functionality.

If you do not know how to configure these settings, contact your network administrator.

8.6.5.6 IP Filter

The camera's IP filter can deny or allow access according to specific IPv4 addresses that you define. By default, the IP filter is disabled (Off).

To define specific IP addresses that can access the camera, click **Allow**. The camera will deny access to all other IP addresses.

To define specific IP addresses that cannot access the camera, click **Deny**. The camera will allow access to all other IP addresses.

To add an IP address to a list, either under Allowed IP Addresses or under Denied IP Addresses, specify an IPv4 address and then click **Add**. You can specify up to 256 IP addresses.

To remove an IP address from a list, click the corresponding trash icon.

8.6.6 Firmware & Info Tab

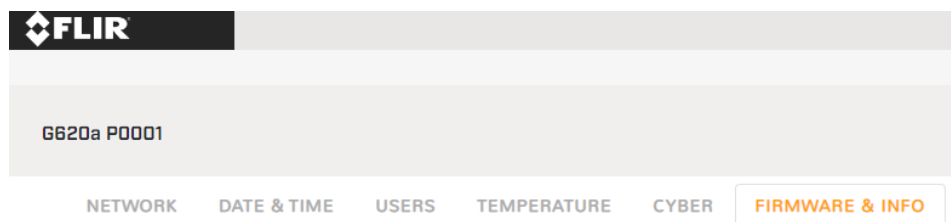

On the Firmware & Info page, you can:

- See the currently installed firmware version and other information about the camera.
- Specify a unique name for the camera.
- Upgrade the camera's firmware.
- Reset the camera's settings to their factory defaults.

Teledyne Confidential; Commercially Sensitive Business Data

G620a & A6301 Camera's User's Manual

WARNING – EAR Controlled Technology (EAR99)

- Reboot the camera.
- Enable logs, define a log level, and download system information.
- Download or upload a configuration backup file.
- Configure camera's analog video output.
- Enable the camera's external illumination feature.

8.6.6.1 Changing the Camera's Name

Name **G620a-1005**

Specify a unique, friendly name for the camera, using only alphanumeric characters. The default name for the camera is the camera model followed by the camera's serial number.

8.6.6.2 Updating the Camera's Firmware

Before upgrading, make sure the device has been recently rebooted

Upgrade Firmware

Find file



UPGRADE

To upgrade the camera's firmware:

1. Make sure the camera has been recently rebooted.
2. Under Upgrade Firmware, click Find file.
3. On your computer or network, browse to and select the firmware file.
4. Click Upgrade



Caution

Only upgrade with firmware developed for G620a or A6301 cameras.

The camera will upload and install the firmware, which takes a minute or two. After the firmware is installed, the camera will require a reboot. When prompted, confirm rebooting of the camera.

8.6.6.3 Restoring the Camera's Factory Defaults

Factory Default Reset and Camera Reboot

FULL RESET

PARTIAL RESET

REBOOT

- **Full Reset** – Resets the camera to its factory default settings, including all IP configurations.
- **Partial Reset** – Resets the camera settings to its factory default settings but preserves the IP configurations.

Teledyne Confidential; Commercially Sensitive Business Data

G620a & A6301 Camera's User's Manual

WARNING – EAR Controlled Technology (EAR99)

- **Reboot** – Reboots the camera and returns to its last saved settings.

Resetting the camera can also be performed by the Reset button on the Rear Panel, see Section 4.1.

8.6.6.4 Support System Info

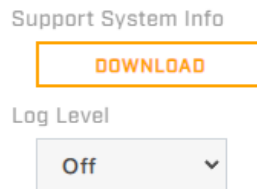

To retrieve the camera's log files, click **Download**.

Set the logging detail up to four levels, higher log levels increase the size of the log file.

8.6.6.5 Configuration Backup

The camera's saved settings can be backed up to a file, or a configuration file can be uploaded to the camera. It is suggested to back up the camera settings once it's installed and configured as desired. Then if the camera is ever replaced, or changes made and needed to go back, a backup file would be available to upload to the camera.



8.6.6.5.1 To upload a configuration file:

1. Click Find File
2. On your computer or network, browse to and select the configuration file.
3. Click **Upload**.

The camera uploads the backup file and requires a reboot.

8.6.6.5.2 To download the camera's saved settings:

1. Click **Download**
2. On your computer or network, browse to the and select the location where you want to save the backup file.

backup.tar.gz is the default backup file name. You can change the backup file name, but do not change the **.tar.gz** file extension.

9 FLIR CamTools

FLIR CamTools is a suite of software tools designed for the FLIR cooled cameras. Three of those tools, IP Config, Camera PlayIR, and Camera Controller, are particularly useful with the G620a and A6301 camera families.

Download FLIR CamTools from <http://support.flir.com/camtools> and then install. The individual applications can then be found under the Windows Start menu in the FLIR Systems folder.

9.1 Camera IP Config

Camera IP Config is a utility program included in FLIR CamTools that provides simple set-up of a FLIR camera's IP settings. Camera IP Config can be started from the Windows Start menu.

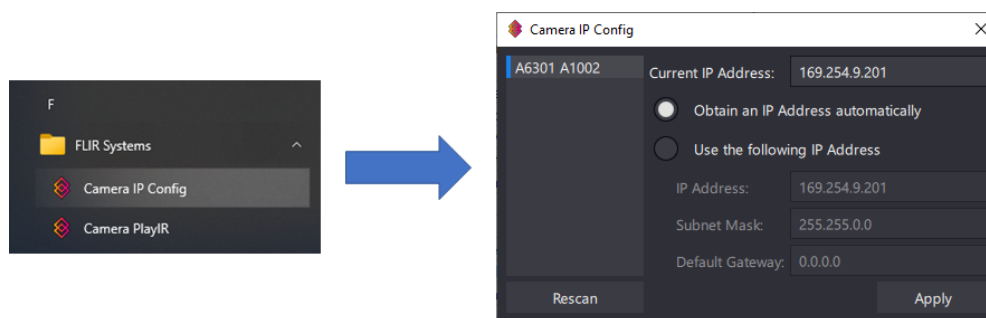

Rescan – When Camera IP Config initially runs it performs a scan for cameras. If no cameras are found, check the ethernet connection between the host and camera and then press Rescan to search for cameras again.

Current IP Address - One feature of Camera IP Config is that it will search for and find cameras connected to a host and report back its Current IP Address. If the camera's address is not compatible with the host's network, after finding the camera Camera IP Config will give the camera a temporary address compatible with the host's network.

Obtain an IP Address Automatically – If highlighted, this means the camera's IP settings are for DHCP. If not highlighted and the user wishes to change the camera to DHCP, select this option and then press Apply

Use the Following IP Address – If highlighted, this means the camera's IP settings is Static and the address specifics are listed. If not highlighted and the user wishes to change the camera to Static, select this option, provide the appropriate addresses, and press Apply.

9.2 Camera PlayIR

Camera PlayIR is a utility program that provides a basic user application for controlling and viewing live streaming video from a camera. It uses the GigE Vision and GenI Cam standards.

The application can be found under the Windows Start menu.





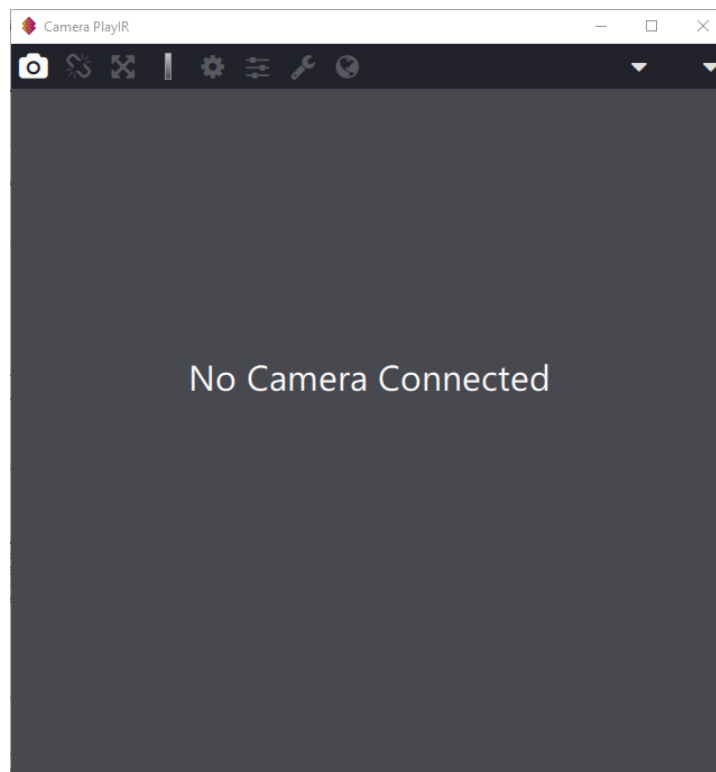





When first opened, Camera PlayIR will look as follows:



9.2.1 Menu Bar Functions

Menu Bar Icon	Description
	Camera Connection – select to find and connect to a camera. Only accessible when not connected to a camera

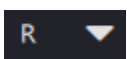
	Unlink – select to disconnect from the camera
	Fit Screen – adjust the zoom to fit the image to the screen. Otherwise, use the mouse wheel to zoom in and out
	Color Pallet – use to select the color pallet to apply to the image
	Camera Controller – opens a GUI for camera control. See Section 9.2 - Camera PlayIR
	Image Enhancement – image scaling options for display.
	Image Display Parameters
	Minimap – Displays the entire image in a smaller window. Used when zoomed in with the main window to give reference to where the zoomed window is in the overall image
	Data Display Value - Select the desired data value to be shown when the cursor is hovering over a pixel. Counts, Radiance, or Temperature
	Data Display Units – Units for the Data Display Value selection

9.2.1.1 Camera Connection

To connect to a camera, press the camera icon. A drop down will be shown. The Last Camera is the last camera the application was connected to. If the host computer is still connected to that camera, then it can be selected and avoid a camera scan process.

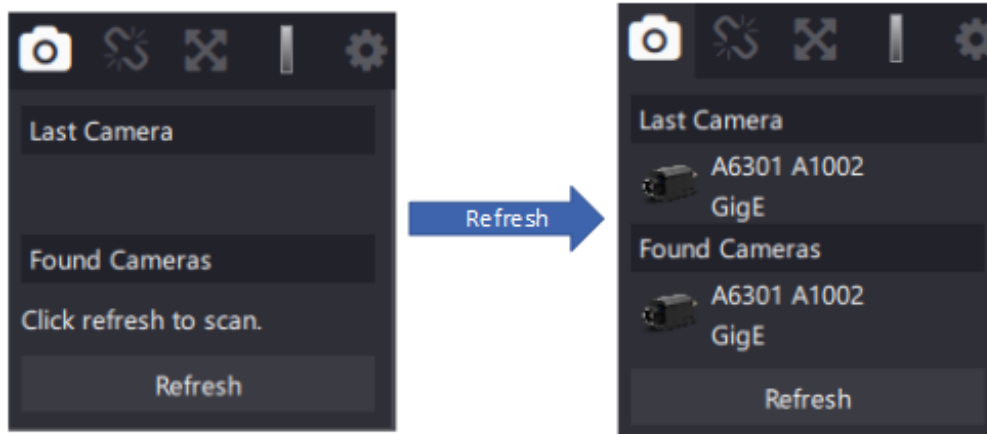

If the Last Camera listed is not the one currently connected to the host, or if there is no camera listed, then a camera scan is required. This is performed by pressing the Refresh button. Once the scan is complete, all cameras connected to the host computer will be displayed under Found Cameras. Select the desired camera to connect.

Once connected, the camera's image will be displayed, camera metadata will be shown on the bottom of the window, and the top menu bar options will become available.

9.2.1.2 Unlink

The Unlink button is shown by a broken chain link. Pressing this button will disconnect Camera PlayeIR from the camera.

9.2.1.3 Fit Screen (Zoom)

Use the mouse wheel to zoom in and out of the image. Use the Fit Screen button to fill the window with the entire image while maintaining the image's aspect ratio.

9.2.1.4 Color Pallet

Infrared images have no color in the traditional sense of cameras. A false color pallet is used to give the digital numbers the camera produces some sort of color so that an image can be shown. Select which false color pallet to use with the Color Pallet button.

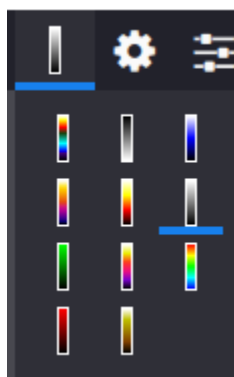

9.2.1.5 Image Enhancement

Selects the AGC algorithm Camera PlayIR uses to convert the image 16-bit data to 8-bit. The drop down selects the algorithm, the scroll bar adjusts the amount of scaling performed. Default is PE (Plateau Histogram Equalization).

Note: This is for the Camera PlayIR display only, it does not affect the camera's non-radiometric output display (RTSP video streams).

9.2.1.6 Image Display Parameters

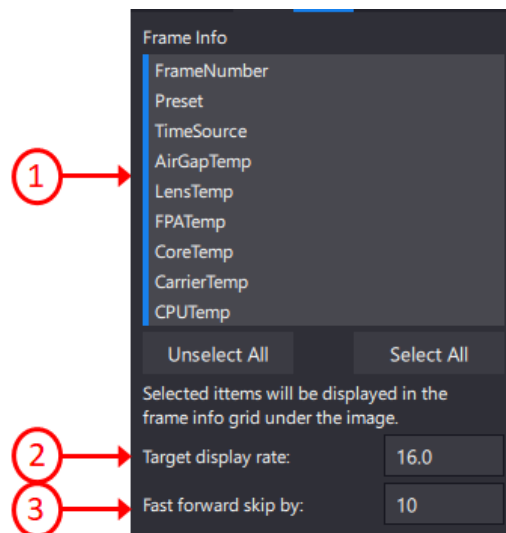

- 1) **Frame Info** – Selects which camera metadata values to display at the bottom of the screen.
 - a. Unselect All – unselects all the metadata values.
 - b. Select All – selects all the metadata values.

- 2) **Target Display Rate** – Sets the desired image display rate in Camera PlayIR. This does not change any settings in the actual camera, but rather the display update rate. Higher rates require more host processing requirements.

9.2.1.7 Minimap

Displays the entire image in a smaller window. Used when zoomed in with the main window to give reference to where the zoomed window is in the overall image.



9.2.1.8 Data Display Value

Select the desired data value to be shown when the cursor is hovering over a pixel. Counts, Radiance, or Temperature

9.2.1.9 Data Display Units

Units for the Data Display Value selection.

9.3 Camera Controller

Camera Controller is a utility program that provides a basic user application for controlling and viewing live streaming video from a camera. It uses the GenI Cam standard.

The application can be launched in Camera PlayIR or FLIR Research Studios. It can also be launched as a stand-alone application from the Windows start menu.



When first opened, Camera Controller will look as follows:

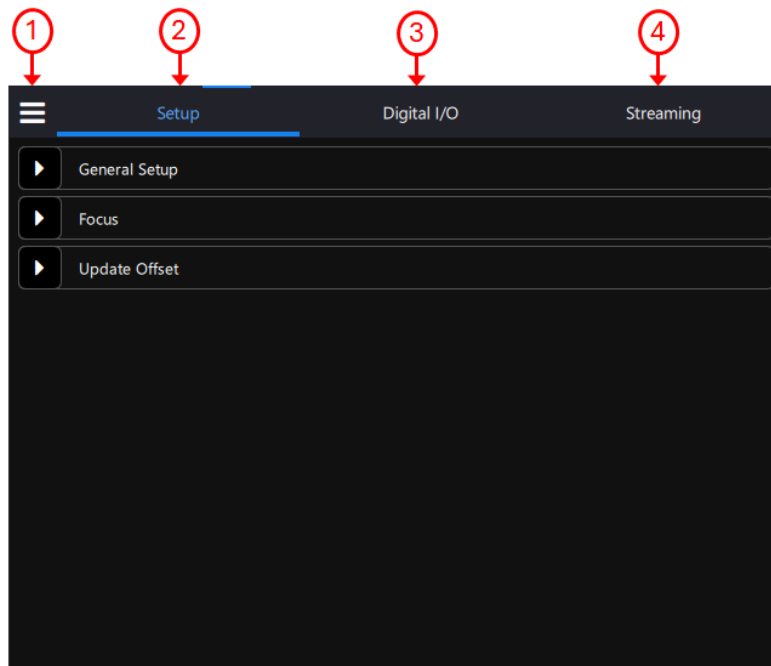

The main sections of the controller are selected across the top.

- 1) **Hamburger Menu** – Top left corner, contains the About selection.
- 2) **Setup Tab** – Controls for the general camera imaging.
- 3) **Digital I/O** – Controls for the user input and output signals on the AUX connector
- 4) **Streaming** – Controls for the data processing on the non-radiometric RTSP streaming output video.

When a change is made in the Camera Controller, it is automatically saved in the camera and will power up in that state.

9.3.1 Hamburger Menu

Contains the About, or About Box, selection for the camera. Selecting it will display information about the camera including all the firmware revisions contained in the camera.



When contacting FLIR Technical Support for any issue, you will often be asked to save a copy of the About screen. Select the Save button on the bottom left corner of the screen to save a copy of the About screen to a .txt file.

9.3.2 Camera Controller – Setup Tab

The Setup Tab contains three groups of controls, General Setup, Focus, and Update Offset

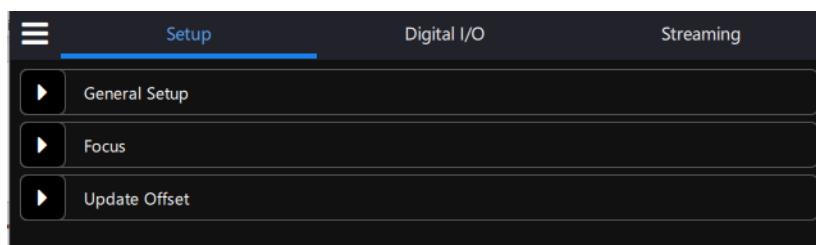

9.3.2.1 Setup Tab - General Setup

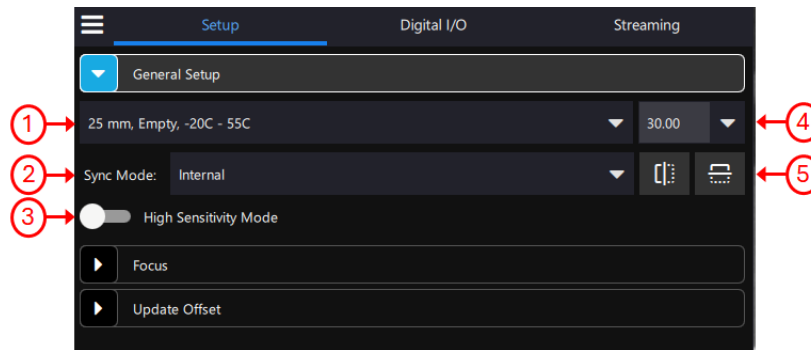

- 1) **Calibration Selection** – Effectively selects the temperature range for the camera to operate by choosing which calibration table to use. The selected calibration table then sets the integration time and loads the NUC table appropriately.

The standard factory naming convention of the Calibration is as follows:

< Lens > , < Filter > , < Temperature Range >

Typically, the Lens will be the same for all selections and the Filter field will be “Empty” unless the camera was ordered with a special warm filter.

Typical operation would be for the user to select the Calibration for which the Temperature Range would cover the scene being imaged.

- 2) **Sync Mode** – selects the internal frame sync or the external input to control the camera’s exposure.
 - a. **Internal** – uses the internal free running sync, set at the Frame Rate Selection
 - b. **External** – uses the Ext Sync input on the rear panel AUX connector.
- 3) **High Sensitivity Mode** - A FLIR-patented algorithm first introduced in the GasFindIR cameras that allows the user to see small temperature changes in the scene.
- 4) **Frame Rate Selection** – selects the frame rate, in hertz (Hz), for the camera to operate at. Use the drop down for standard values or click in the box and manually type the desired rate.
- 5) **Image Orientation** – Flips the image horizontally (HFlip) and/or vertically (VFlip). Mainly used when the camera is mounted upside down or sideways.

9.3.2.2 Setup Tab – Focus

Only available for cameras with a motorized lens, such as the G620a.

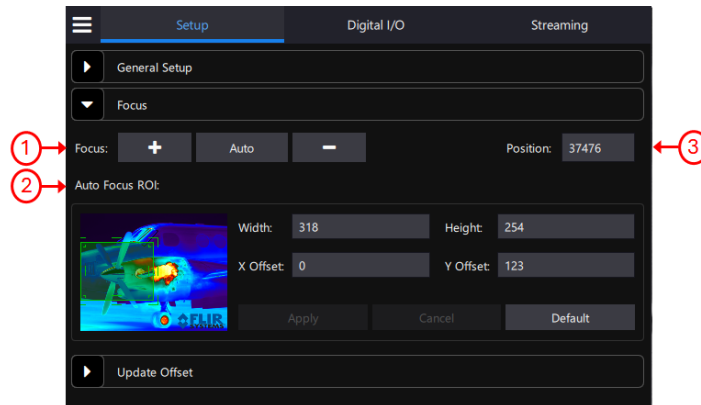

- 1) **Focus** – Controls the position of the lens
 - a. **+** (**Focus Farther**) - Moves the lens towards infinity
 - b. **Auto** – Performs an autofocus using the portion of the image as defined by the Auto Focus ROI
 - c. **-** (**Focus Nearer**) – Moves the lens towards the minimal focus point
- 2) **Auto Focus ROI** – The Auto Focus ROI (Region of Interest) defines the portion of the image the Auto Focus routine uses to focus the camera.

If selected via the REST API, the ROI will be displayed on the RTSP video overlay. However, the ROI will not be shown on GigE Vision streaming data. A host application displaying GigE Vision images may place the ROI on the image itself. For example, both Camera PlayIR and FLIR Research Studios use the camera's GigE Vision data stream. Camera PlayIR does not show the Focus ROI on the image, however, FLIR Research Studios does.

- 3) **Position** – Displays the lens position in encoder counts. The position can also be manually entered into the text box to command the lens to go to predetermined focus positions.

9.3.2.3 Setup Tab – Update Offset

Controls when and how an Update Offset, also called a Flat Field Correction (FFC), is performed.

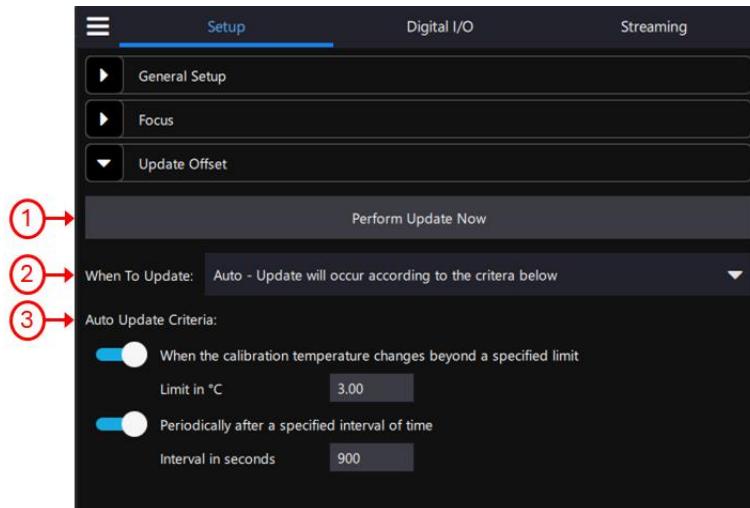

- 1) **Perform Manual Update Now** – Select button to manually request an Update Offset. Can be pressed regardless of the When To Update selection.
- 2) **When To Update** – Select when to perform an Update Offset
 - a. **Manual** - Update will occur only when a user requests it; camera uses the internal flag and thus only corrects camera electronics drift.
 - b. **Auto** – Update Offsets will occur based on the Auto Update Criteria selections. Camera uses the internal flag.
 - c. **External** – Update will occur only when a user requests it; camera uses a user supplied external flag (flat field). This allows for the Update Offset to correct for lens drift as well as electronics.
- 3) **Auto Update Criteria** – Sets the conditions for when the camera performs an Auto Update Offset. The Update Offset can be set to occur every so many seconds and/or when the electronics change by so many degrees Celsius (based on the Calibration Temperature Sensor). The slider bar can be used to disable one of the conditions. Setting the value to 0 also disables that condition.

9.3.3 Camera Controller – Digital I/O Tab

User control of the two digital inputs and two digital outputs on the camera's rear panel AUX connector.

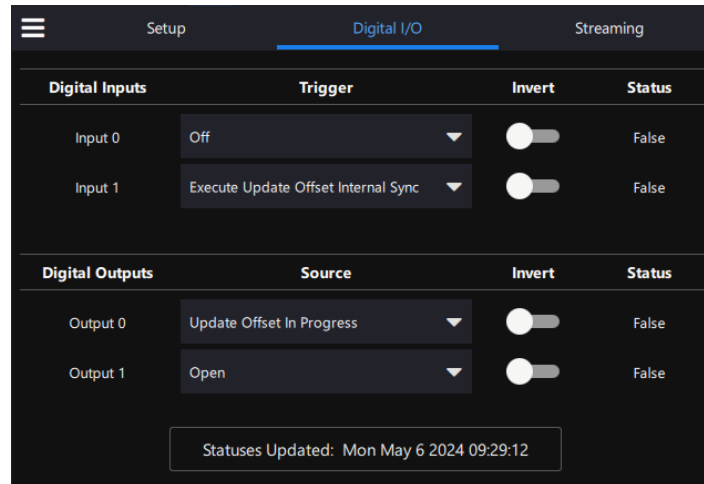

9.3.3.1 Digital I/O Tab – Digital Inputs

- **Trigger** – Selects what happens when the Input sees an active signal.
 - **Off** – Nothing happens.
 - **Execute Update Offset** – Performs an Update Offset on the active edge of the input. When running in External Sync mode, must provide a streaming set of syncs during the Update Offset process
 - **Execute Update Offset Internal Sync** – Switches to the Internal Sync source first and then performs an Update Offset on the active edge of the input. Use this when running the camera in External Sync but cannot provide a streaming set of syncs for the Update Offset process.
- **Invert** – Selects the active edge / steady state level of the input
 - **Disabled** – the active level of the input is high. Uses the rising edge for the active edge.
 - **Enabled** – the active level of the input is low. Uses the falling edge for the active edge.
- **Status** – Indicates the current status of the input.

9.3.3.2 Digital I/O Tab – Digital Outputs

Both digital outputs correspond to a set of pins, A/B, on the rear panel AUX connector which act as a switch. When the output is “Open”, that means the pins are disconnected. When the output is “Closed” the pins are connected.

- **Source** – Selects what the source is for the output.
 - **Open** – The output switch is open; the A/B pins are not connected. Also called Off or False.
 - **Closed** – the output switch is closed; the A/B pins are shorted together. Also called On or True.
 - **Update Offset in Progress** – Closes to indicate when an Update Offset is in progress and the output images are not usable.
- **Invert** – Inverts the output action.
- **Status** – Indicates the current status of the output.

9.3.4 Camera Controller – Streaming Tab

User control over the RTSP, non-radiometric video streams. None of the controls effect the GigE Vision data stream and thus the results will not be seen in Camera PlayIR or FLIR Research Studios.

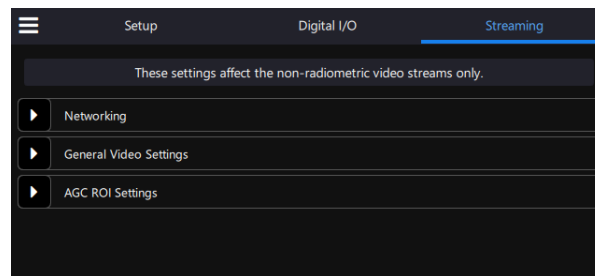

9.3.4.1 Streaming Tab – Networking

The Networking pull down is mainly for informational purposes.

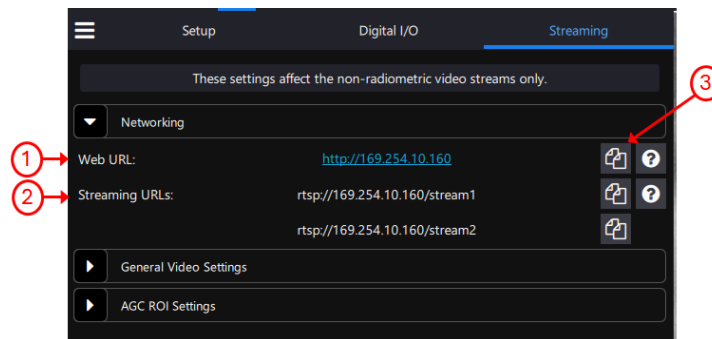

Teledyne Confidential; Commercially Sensitive Business Data

G620a & A6301 Camera's User's Manual

WARNING – EAR Controlled Technology (EAR99)

- 1) **Web URL** – URL to use in a standard web browsers address bar to connect to the camera's internal Web Browser
- 2) **Streaming URLs** – Typical URL to use in an RTSP display program to access the camera's two RTSP streams.
- 3) **Copy to Clipboard** – Copies the URL to the clipboard so the user can “paste” the URL in another program.

9.3.4.2 Streaming Tab – General Video Settings

The General Video Settings configures the non-radiometric camera outputs, such as the RTSP video. Changes to this window do not appear in the GigE Vision video (Camera PlayIR or FLIR Research Studios displays).

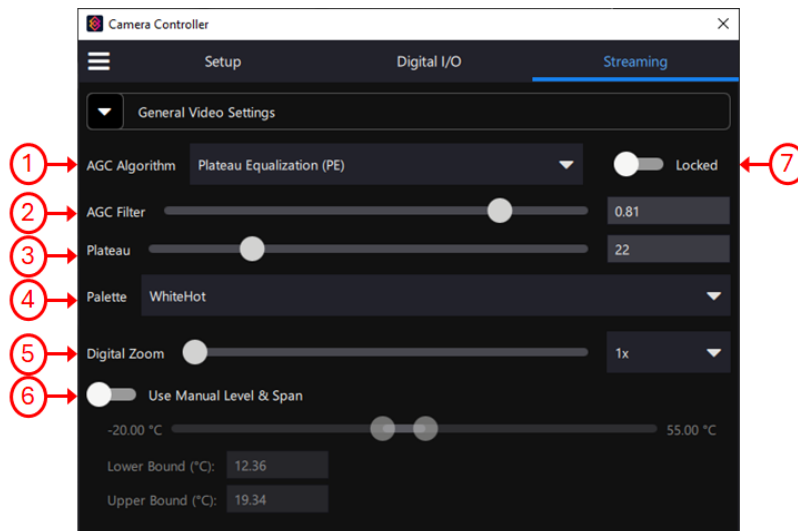

- 1) **AGC Algorithm** – (Automatic Gain Control) Scaling algorithm the camera uses to convert the 16-bit data to 8-bit for display.
 - a. **Linear** – Simple gain/offset method for scaling.
 - b. **Plateau Equalization (PE)** – a non-linear algorithm which scales the 16-bit image data to 8-bit based on a histogram of the data.
- 2) **AGC Filter** - Determines how quickly a scene adjusts when a hot object appears (or disappears) within the AGC ROI. If set to a low value, when a hot object enters the ROI the AGC will adjust more slowly resulting in a more gradual transition of the scaling.
- 3) **Plateau Value** - Scaling factor for the Plateau Equalization (PE) algorithm.

Teledyne Confidential; Commercially Sensitive Business Data

G620a & A6301 Camera's User's Manual

WARNING – EAR Controlled Technology (EAR99)

- 4) **Palette** - Select the color palette the camera uses to indicate detected levels of thermal energy. WhiteHot and BlackHot are gray-scale palettes; other palettes assign different colors to different temperatures.
- 5) **Digital Zoom** – Selects the camera’s digital zoom level, x1, x2, x4, or x8.
- 6) **Use Manual Level & Span** – Allows user control over the scaling algorithm to set the max and min temperature range to scale to (also called MGC or Manual Gain Control). Used when the image contains high and/or low temperature objects that are not of interest and wish to be excluded from the scaling algorithm to allow for better resolution of the images which are of interest.
- 7) **Locked** – Locks the AGC to the last computed values. Helpful when doing frame comparisons over a short period of time and don’t want the AGC updates to change pixel values between frames.

9.3.4.3 Streaming Tab – AGC ROI Settings

Controls what portion of the image the AGC algorithm uses.

10 Maintenance

10.1 Camera Body, Cables, and Accessories

The camera body, cables and accessories may be cleaned by wiping with a soft cloth. To remove stains, wipe with a soft cloth moistened with a mild detergent solution and wrung dry, then wipe with a dry soft cloth.

Do not use benzene, thinner, or any other chemical product on the camera, the cables or the accessories, as this may cause deterioration.

10.2 Lenses

The lens can be cleaned using a soft Cotton Wool cloth and one of these liquids:

- A commercial lens cleaning liquid with more than 30% isopropyl alcohol.
- 96% ethyl alcohol (C₂H₅OH)

Soak the cotton wool in the liquid and then twist to remove excess liquid. Clean the lens one time only, discard the cotton wool.



Caution

If you use a lens cleaning cloth it must be dry. Do not use a lens cleaning cloth with the liquids that are listed above. These liquids can cause material on the lens cleaning cloth to become loose. This material can have an unwanted effect on the surface of the lens.



Warning

Make sure that you read all applicable MSDS (Material Safety Data Sheets) and warning labels on containers before you use a liquid: the liquids can be dangerous.



Caution

- Be careful when you clean the infrared lens. The lens has a delicate anti-reflective coating.
- Do not clean the infrared lens too vigorously. This can damage the anti-reflective coating.

Appendix A - G620a Mechanical Dimensions

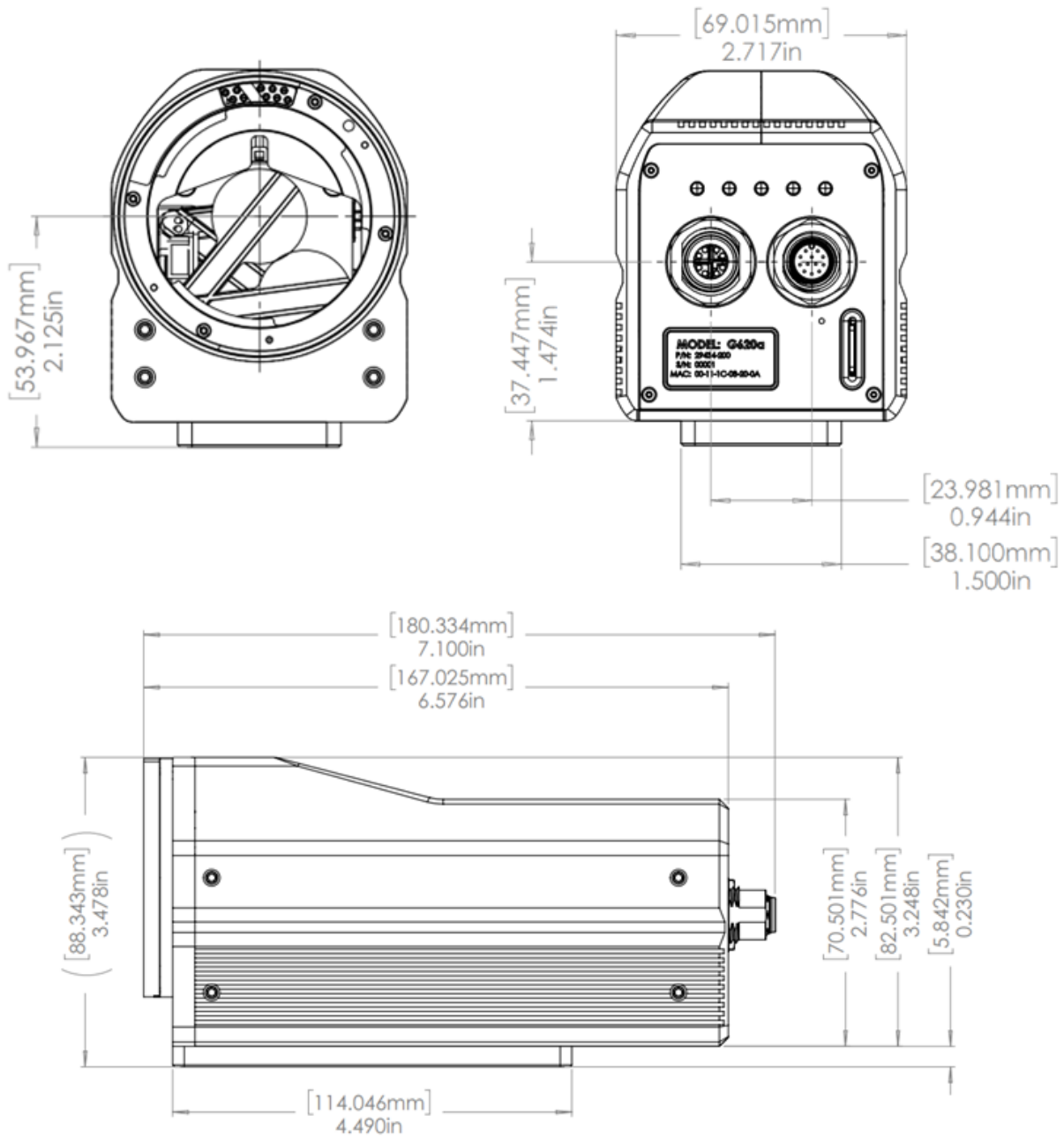

Teledyne Confidential; Commercially Sensitive Business Data

G620a & A6301 Camera's User's Manual

WARNING – EAR Controlled Technology (EAR99)

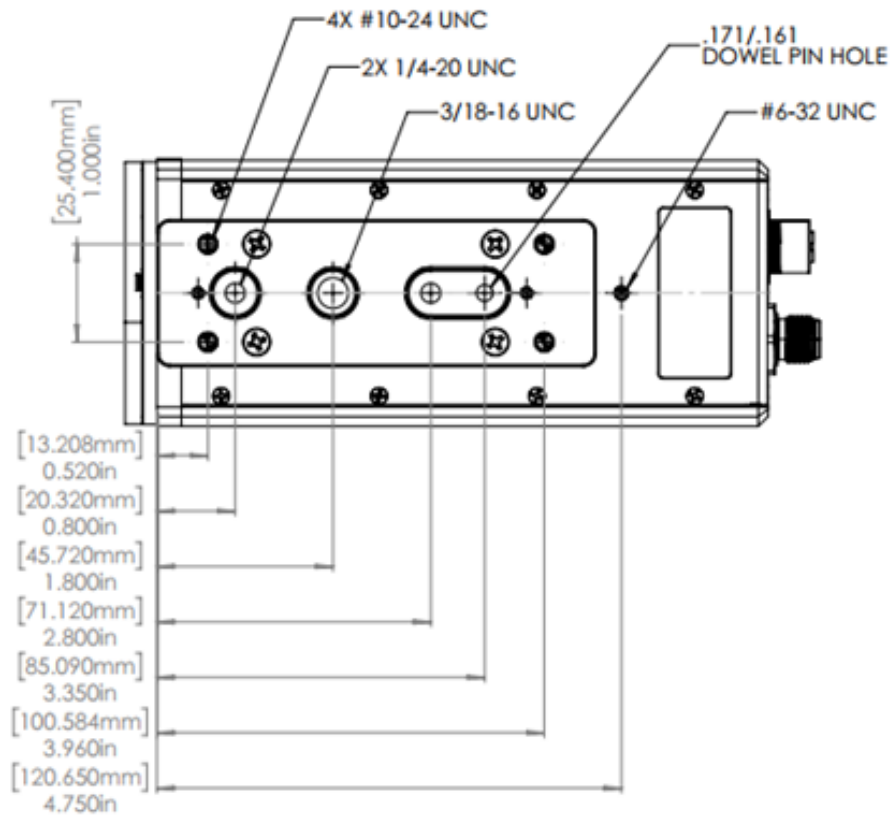

WITH TRIPOD MOUNT

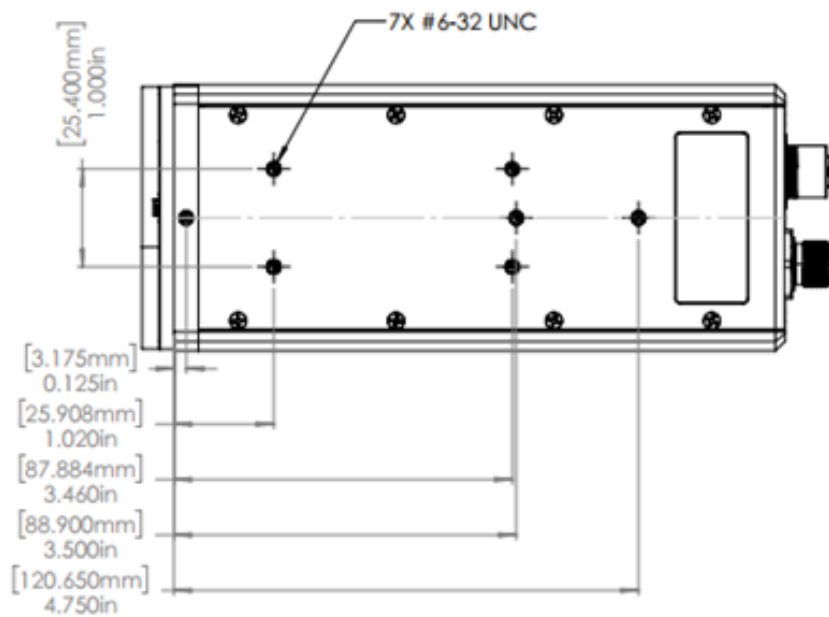

WITHOUT TRIPOD MOUNT

Teledyne Confidential; Commercially Sensitive Business Data

G620a & A6301 Camera's User's Manual

WARNING – EAR Controlled Technology (EAR99)

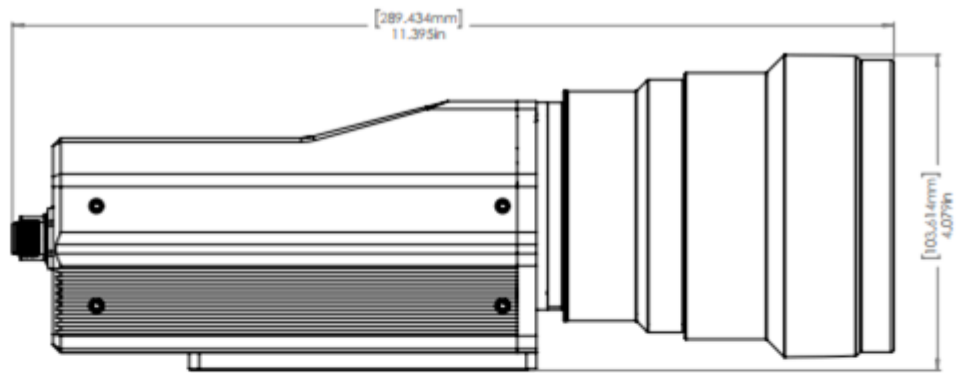

29434-201: G620a + 6 DEGREE LENS

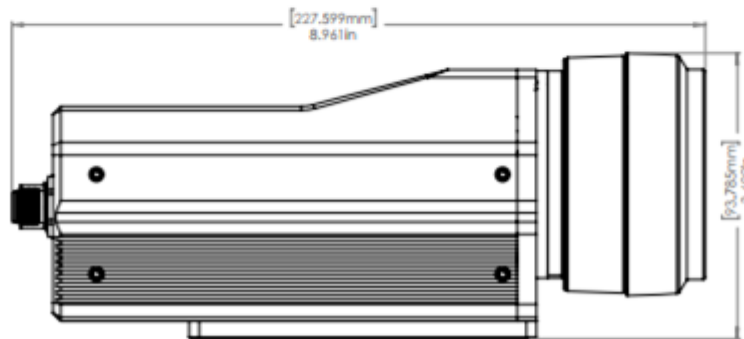

29434-202/203: G620a + 14.5/24 DEGREE LENS

Appendix B - A6301 Mechanical Dimensions

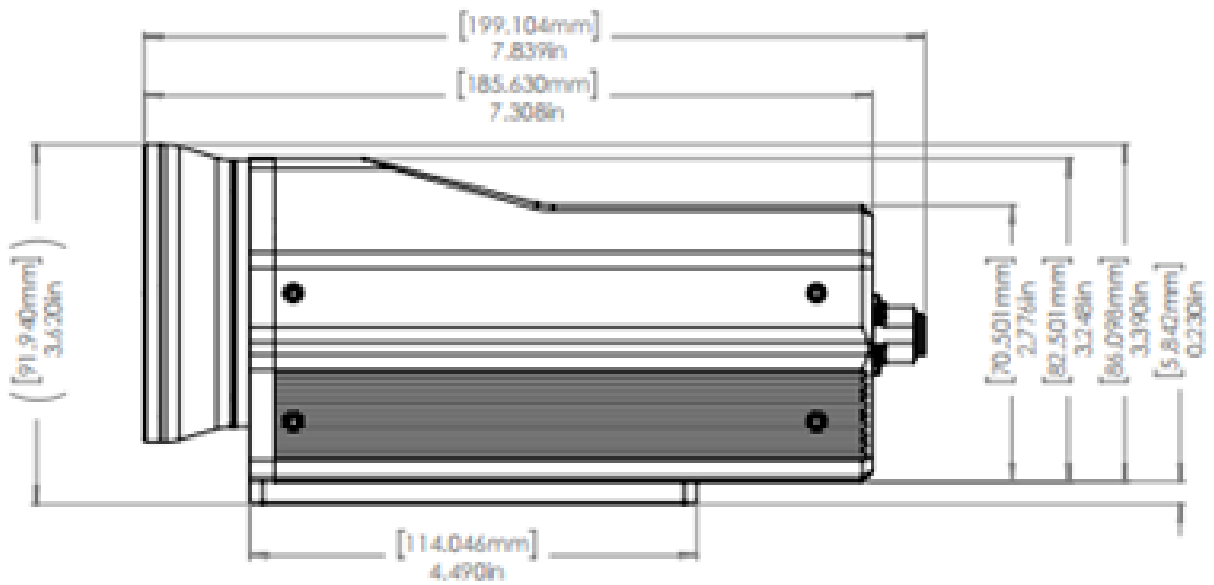
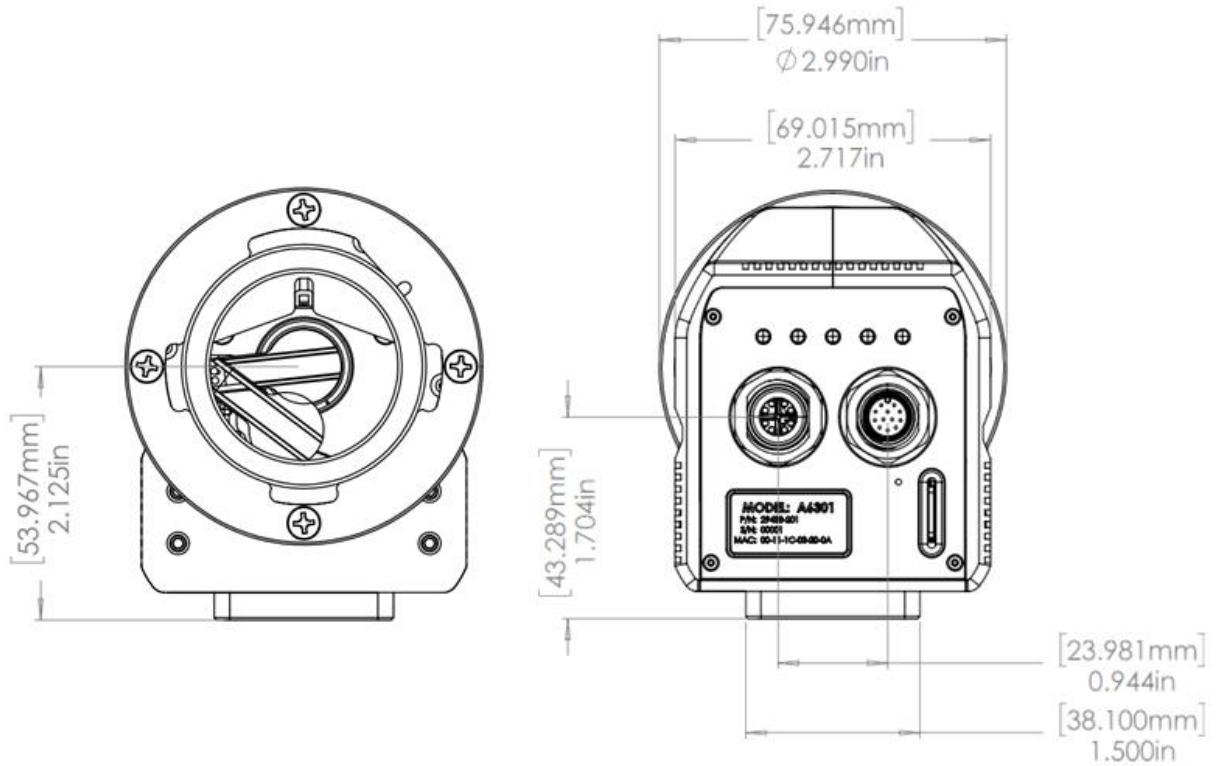

Teledyne Confidential; Commercially Sensitive Business Data

G620a & A6301 Camera's User's Manual

WARNING – EAR Controlled Technology (EAR99)

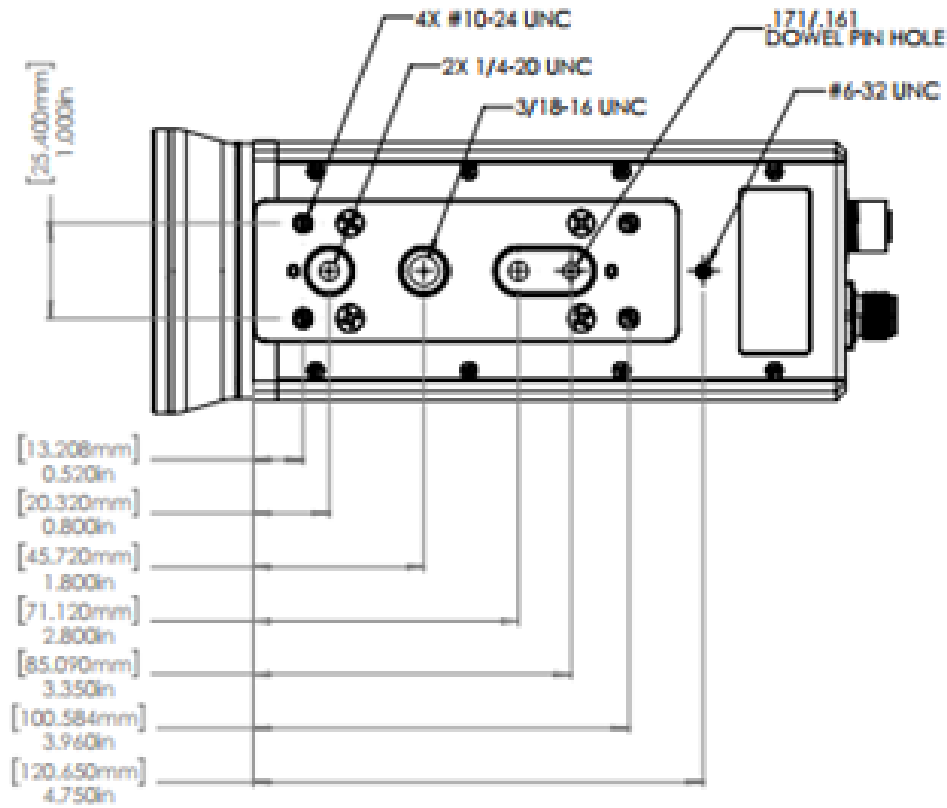

WITH TRIPOD MOUNT

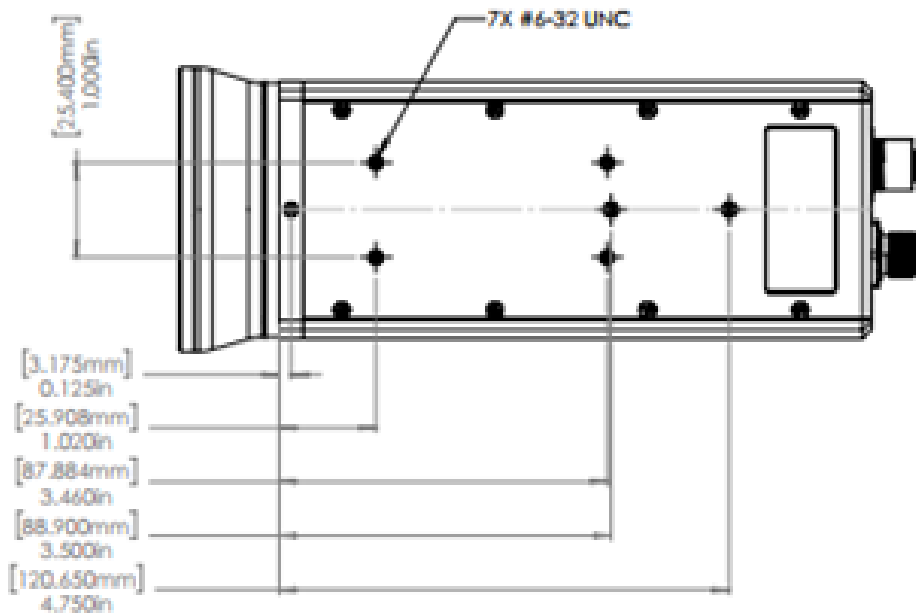

WITHOUT TRIPOD MOUNT

Teledyne Confidential; Commercially Sensitive Business Data

G620a & A6301 Camera's User's Manual

WARNING – EAR Controlled Technology (EAR99)

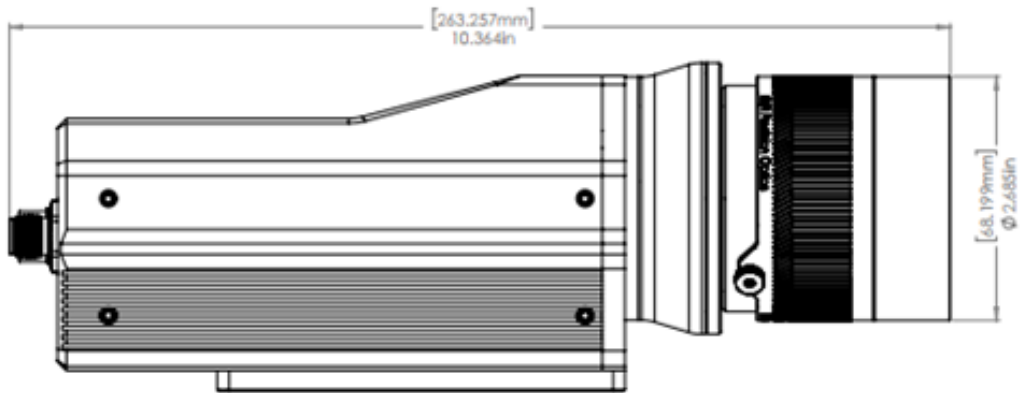

29433-206: A6301 + 17mm LENS

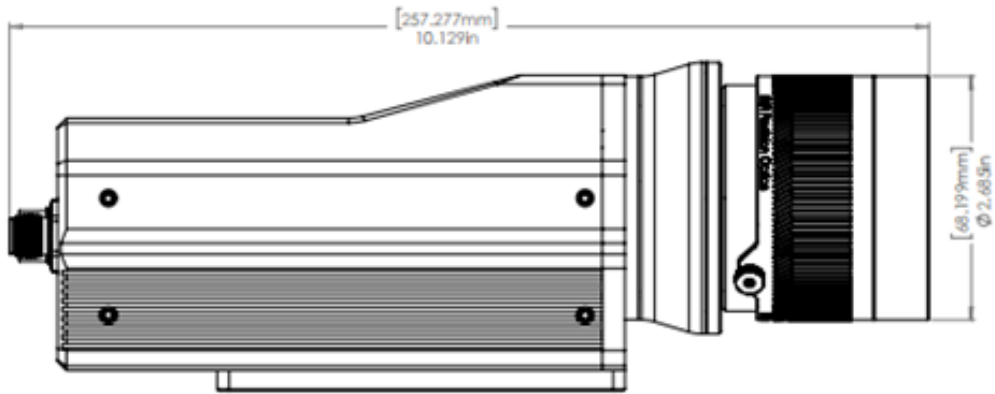

29433-207: A6301 + 25mm LENS

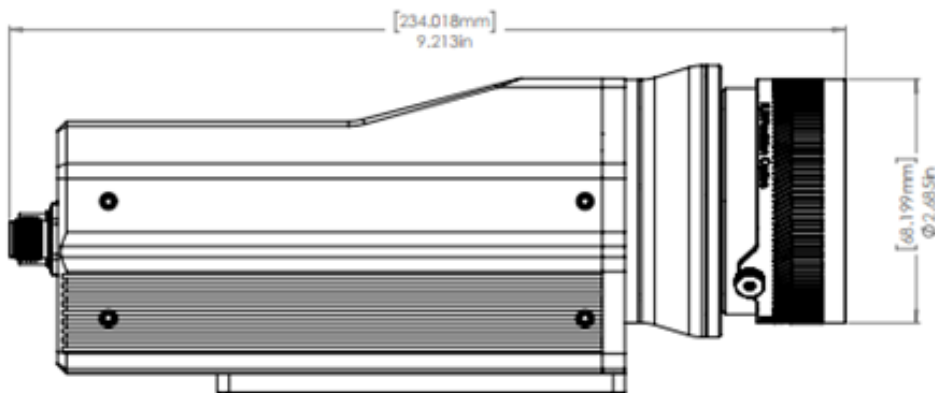

29433-208: A6301 + 50mm LENS

Teledyne Confidential; Commercially Sensitive Business Data

G620a & A6301 Camera's User's Manual

WARNING – EAR Controlled Technology (EAR99)