



User's manual FLIR G series

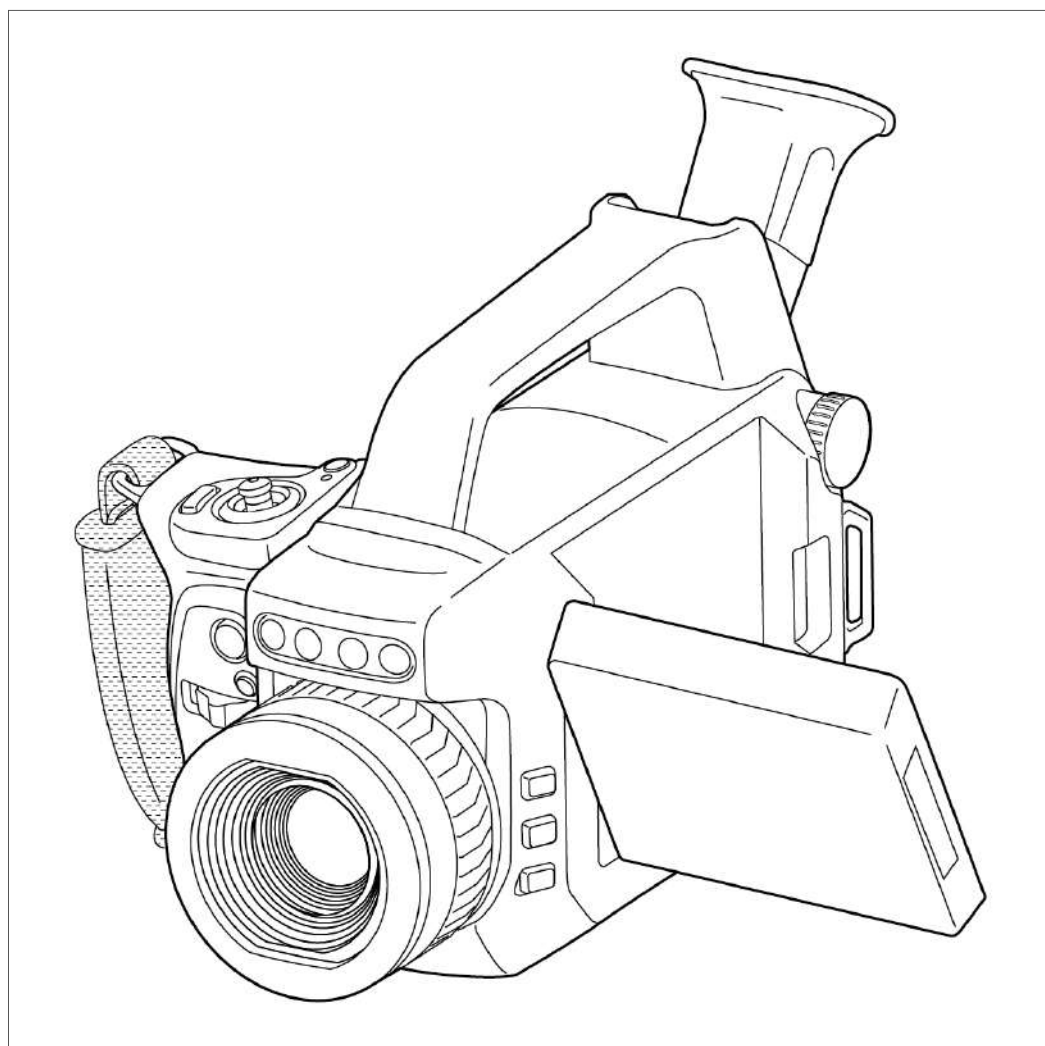

Table of contents

1	Notice to user	1
1.1	Safety information	1
1.2	Register your camera.....	1
1.3	Online documentation.....	1
1.4	About this manual	1
1.5	Support	1
1.6	Training	2
2	Introduction	3
2.1	Benefits	3
3	Getting started	4
3.1	Safety information	4
3.2	Start the camera	4
3.3	Unlock the camera	4
3.3.1	Get unlock code.....	4
3.3.2	Enter unlock code in camera.....	5
3.4	Detect a gas leak	5
3.5	Measure a temperature	5
4	Camera parts	6
4.1	View from the front	6
4.2	View from the rear.....	7
4.3	View from the left	7
4.4	Connector and battery compartment	8
4.5	Serial number	8
4.6	Laser pointer	9
5	User interface	10
5.1	Screen elements	10
5.1.1	General.....	10
5.1.2	Status icons and indicators.....	10
5.2	Mode selection menu	11
5.2.1	Navigation	11
5.3	Main toolbar	12
5.3.1	Navigation	12
5.4	Quick menu	13
5.4.1	Navigation	13
5.5	Image overlay	14
6	Basic operation	15
6.1	Safety information	15
6.2	Battery	15
6.2.1	Install the battery.....	15
6.2.2	Remove the battery	16
6.2.3	Battery indicator.....	16
6.3	Battery charging	17
6.3.1	Battery indicator — charging.....	17
6.3.2	Charge the battery using the battery charger	17
6.3.3	Charge the battery in the camera	17
6.4	Power on/off	18
6.4.1	Power on.....	18
6.4.2	Power off.....	18
6.5	Display	19
6.6	Viewfinder.....	20
6.7	Ergonomics	21
6.8	Focus.....	22
6.8.1	Manual focus.....	22
6.8.2	Autofocus	22

Table of contents

6.9	Temperature range.....	23
6.10	Mode wheel.....	24
6.11	Save and record	25
6.11.1	Save an image.....	25
6.11.2	Record a video	25
6.12	Zoom	26
6.13	Programmable buttons.....	27
6.14	Laser pointer	28
6.15	File transfer	28
6.15.1	Transfer files via USB cable	28
6.16	Camera lamps.....	29
6.17	Knob screw	29
6.18	Change the lenses	30
6.19	Attach the heat shield	33
7	Thermal imaging basics	35
7.1	Focus.....	35
7.1.1	Adjust focus	35
7.2	Temperature range.....	35
7.2.1	Change the temperature range.....	36
7.3	Thermal image adjustment.....	36
7.3.1	Manual mode	36
7.3.2	Manual adjustment by touching the screen	37
7.3.3	Manual adjustment using the joystick.....	38
7.3.4	Auto adjustment region.....	38
7.4	Color palettes	39
7.4.1	Change the color palette.....	39
8	Detecting a gas leak.....	40
8.1	Basic steps to gas detection.....	40
8.2	Adjust the camera focus	40
8.3	Delta T	40
8.4	High Sensitivity Mode (HSM).....	40
8.4.1	Using HSM	41
8.5	Adjust the temperature scale	41
8.6	Change the color palette	41
8.7	Change the temperature range	41
9	Quantification	43
9.1	Introduction	43
9.1.1	Field equipment	43
9.2	User interface	43
9.2.1	Quantification parameters	44
9.2.2	Type of measurement.....	44
9.2.3	Radiometric video recording.....	45
9.3	Perform a quantification measurement.....	45
9.3.1	Main steps.....	45
9.3.2	Select a measurement position	45
9.3.3	Place the camera	45
9.3.4	Enter Quantification mode.....	45
9.3.5	Set the quantification parameters.....	45
9.3.6	Ensure minimum delta temperature	46
9.3.7	Start the measurement	46
9.3.8	Quantification results	47
9.3.9	Save quantification files as a pdf report	48
9.3.10	Transfer quantification files	48
9.4	Practical information.....	48
9.4.1	Measurement position.....	48

Table of contents

	9.4.2	Measure Ambient Temperature	48
	9.4.3	Assessing delta temperature	49
	9.4.4	Camera temperature range	49
	9.4.5	Field of view and focus	49
	9.4.6	Leak rate versus concentration	50
	9.5	Method limits	50
10		Measuring temperatures	51
	10.1	Basic steps to temperature measurements	51
	10.2	Measurement tools	51
	10.2.1	Add and remove a tool	51
	10.2.2	Edit a user preset	51
	10.2.3	Move and resize a tool	52
	10.2.4	Display values in the result table	53
	10.2.5	Display a graph	53
	10.2.6	Set up a difference calculation	53
	10.2.7	Set up a measurement alarm	54
	10.3	Temperature range	55
	10.4	Adjust the temperature scale	55
	10.5	Measurement parameters	55
	10.5.1	Types of parameters	55
	10.5.2	Recommended values	56
	10.5.3	Set the measurement parameters	56
	10.6	Color alarms and isotherms	57
	10.6.1	Set up a color alarm	58
11		Working with images	59
	11.1	Save an image	59
	11.1.1	Preview an image	59
	11.2	Annotate an image	59
	11.2.1	Text comment table	60
	11.2.2	Voice annotation	62
	11.3	About image files	62
	11.3.1	File-naming convention	62
	11.3.2	Image files	62
12		Recording	63
	12.1	Record a video	63
	12.2	Periodic saving (time-lapse)	63
	12.3	Multi-Rec	63
	12.3.1	Set up recording	63
	12.3.2	Start recording	64
13		Gallery — video and image archive	65
	13.1	Open the Gallery	65
	13.2	Open video and image files	65
	13.3	Edit an image	65
	13.4	Save file as a pdf report	66
	13.5	Add a folder	66
	13.6	Rename a folder	66
	13.7	Change the active folder	66
	13.8	Move files between folders	67
	13.9	Upload files and folders	67
	13.10	Delete files and folders	67
	13.10.1	Delete folders	67
	13.10.2	Delete a file	67
	13.10.3	Delete multiple files	67
	13.10.4	Delete all files	68

Table of contents

14	Wireless connectivity	69
14.1	Wi-Fi.....	69
14.1.1	Connect the camera to Wi-Fi	69
14.1.2	Set up the camera as a wireless access point.....	69
14.2	Bluetooth	69
14.2.1	Pair Bluetooth devices.....	69
14.3	Cloud connectivity.....	70
14.3.1	Setup	70
14.3.2	Create FLIR Ignite account.....	70
14.3.3	Connect camera to internet	70
14.3.4	Pair with FLIR Ignite.....	70
14.3.5	Automatic upload	70
14.3.6	Manual upload.....	71
14.3.7	Access FLIR Ignite	71
14.4	Camera web interface.....	71
14.4.1	Connect the camera to the local network	71
14.4.2	Open the camera web interface.....	72
14.4.3	Download files.....	72
15	Inspection Route	73
15.1	General	73
15.1.1	FLIR Inspection Route Solution user manual	73
15.2	User interface	73
15.2.1	Drop-down menu	74
15.2.2	Inspection list	74
15.3	Performing an inspection	75
15.3.1	Preparation.....	75
15.3.2	Capturing inspection data	76
15.3.3	Editing inspection point data.....	77
15.3.4	Saving an image	77
15.3.5	Recording a video clip	77
15.3.6	Viewing and editing inspection images.....	77
15.3.7	Inspection list	78
15.3.8	Adding an inspection point	78
15.3.9	Transferring inspection results.....	78
15.4	Configuration	79
15.5	Creating an inspection route.....	80
15.5.1	Creating an inspection route in the camera	80
15.5.2	Manually editing an XML file	80
16	Camera settings	82
16.1	FLIR Ignite	82
16.2	Connections	82
16.3	Quantification.....	82
16.4	Multi-Rec settings	82
16.5	Camera temperature range	82
16.6	Save options & storage	83
16.7	Device settings.....	83
17	Maintenance and cleaning	85
17.1	General check.....	85
17.2	Clean the camera	85
17.2.1	Camera housing, cables, and other items	85
17.2.2	Infrared lens.....	85
17.2.3	Infrared detector	86
17.3	Cooler maintenance	86
17.3.1	General.....	86
17.3.2	Signs to watch for.....	86

Table of contents

17.4	Camera calibration.....	86
18	Updating the camera.....	88
18.1	Update the camera Over-The-Air (OTA)	88
18.2	Update via USB cable with the FLIR Camera Updater	88
18.2.1	Install the FLIR Camera Updater.....	88
18.2.2	Connect the camera	88
18.2.3	Update notifications	88
19	Disposal of electronic waste	89
19.1	Battery removal	89
20	Disclaimers	90
20.1	Legal disclaimer	90
20.2	Export controls	90
20.3	Patents	90
20.4	Quality assurance	90
20.5	Third-party licenses.....	90
20.6	Usage statistics	90
20.7	Copyright	90

1.1 Safety information

Before operating the camera, you must read, understand, and follow the warnings and cautions in the *Safety information* publication.

For the FLIR Gx models, there is a dedicated *Safety information* publication, including warnings and cautions related to explosive and hazardous locations.

The *Safety information* publication is supplied with the camera. It is also available at the following internet address: <https://support.flir.com/resources/b9rp>.

1.2 Register your camera

Register your camera to receive an extended warranty and other benefits.

To register the camera, go to <https://support.flir.com/camreg>.

To access the registration form, you must log in to your FLIR account or sign up for a new account.

You will also need the serial number of your camera. The serial number is displayed by the registration wizard in the camera. See also section 4.5 *Serial number*.

To start the registration wizard, turn on the camera and select *Settings > Device settings > Camera information > Register camera*.

To complete the registration, you must enter a verification code into the camera. The code is available in your FLIR account, under *My Products*.

1.3 Online documentation

Our manuals are continuously updated and published online.

To access the FLIR G series user manual and other product documentation, go to <https://support.flir.com/resources/b9rp>.

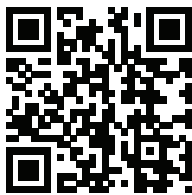

To access the manuals for our other products, as well as manuals for our discontinued products, go to <https://support.flir.com/resources/app>.

1.4 About this manual

FLIR Systems issues generic manuals that cover several models within a camera series. This means that this manual may contain descriptions and explanations that do not apply to your particular camera model.

The authoritative version of this publication is English. In the event of divergences due to translation errors, the English text has precedence. Any late changes are first implemented in English.

1.5 Support

Contact our Technical Support Center if you experience problems or have any questions about your product: <https://support.flir.com>.

1.6 Training

Thermal inspection of gas leaks—including thermal image and other data acquisition, analysis, diagnosis, prognosis, and reporting—is a highly advanced skill. It requires professional knowledge of thermography and its applications, and is, in some countries, subject to certification and legislation. Consequently, we strongly recommend that you seek the necessary training before carrying out inspections.

For training and certification courses, go to <https://www.flir.com/support-center/training>.



The FLIR G series is the latest addition to Optical Gas Imaging (OGI) with focus on the digital oilfield. While maintaining best in class image quality and gas detection sensitivity, it offers new features such as wireless connectivity and connection to the FLIR cloud.

2.1 Benefits

Newest in technology to meet today's operator

- The most easily connectable OGI camera
- Wireless communication
- Compatible with FLIR Ignite
- Easy to integrate with LDAR software

Both see and measure the gas leak in the camera

Unmatched gas sensitivity and advanced analytics onboard camera

- Quantification inside camera (Hydrocarbon version)
- 320 and 640 options available (Hydrocarbon version)
- Compliant with existing regulations (FLIR Gx version)

Better ergonomics and easier to operate

Refreshed hardware addressing user issues but maintaining a familiar experience

- Touch LCD screen
- Field exchangeable lenses
- Improved hardware and updated GUI

3.1 Safety information

Before operating the camera, you must read, understand, and follow the warnings and cautions in the *Safety information* publication.

For the FLIR Gx models, there is a dedicated *Safety information* publication, including warnings and cautions related to explosive and hazardous locations.

The *Safety information* publication is supplied with the camera. It is also available at the following internet address: <https://support.flir.com/resources/b9rp>.

3.2 Start the camera

1. Charge the battery. The battery is fully charged when all battery indicator lights are steady on.
2. Open the cover at the rear of the camera.
3. Push the battery into the battery compartment.
4. Insert a memory card into the card slot.

Note Empty or use a memory card that has not previously been used in another type of camera. The cameras may organize files differently on the memory card. There is therefore a risk of losing data if the same memory card is used in different types of cameras.

5. Close the cover. Tighten the screw.
6. Push the On/Off button to power on the camera.

Note A mechanical cooler will start to cool down the sensor. The loud cooler sound is fully normal. When the cooling procedure is completed, there is a distinct change of the sound.

7. Follow the instructions on the camera screen to set up the camera according to your preferences.

Applicable to FLIR Gx models: To make the camera fully operational, you must unlock the camera by entering a camera unique code. For more information, see section 3.3 *Unlock the camera*.

Note You can select the settings as a part of the initial setup of the camera or later at any time via the *Settings* menu.

3.3 Unlock the camera

The FLIR Gx camera is certified for use in hazardous locations. To make the FLIR Gx camera fully operational, you must unlock the camera by entering a camera unique code. To get the unlock code, you must log in to a FLIR account and register the camera.

Note The next time you turn on the camera, it will be fully operational from its start-up. You do not have to go through the unlock procedure again.

3.3.1 Get unlock code

Use a computer or other device with internet access and go to <http://support.flir.com/unlock>.

To access the registration form, you must log in to your FLIR account or sign up for a new account.

You will also need the serial number of your camera. The serial number (S/N) is displayed by the setup wizard in the camera. See also section 4.5 *Serial number*.

When you have registered the camera, the unlock code will be available in your FLIR account, under *My Products*.

3.3.2 Enter unlock code in camera

To enter the unlock code in the camera, do the following:

- Move the joystick up/down to select a digit.
- Move the joystick left/right to navigate to the previous/next digit.
- When the last digit has been entered, move the joystick right to select *Continue*. Push the joystick to confirm.

3.4 Detect a gas leak

1. Aim the camera toward the object of interest.
2. Adjust the camera focus. If the camera is out of focus, there is a risk of missing a gas leak.
3. If there is a gas leak, and the gas is one of the gases that the camera can detect, you will now see the leak on the screen. The leak will look like a smoke plume coming from the point of the leak.

Note To obtain optimal contrast, try to find a suitable background by aiming the camera toward the object from different angles.

Using the High Sensitivity Mode (HSM) can improve the detection of gas leaks. For more information, see section 8.4 *High Sensitivity Mode (HSM)*.

4. To record a video clip, do the following:
 - 4.1. Turn the mode wheel and select *Video*.
 - 4.2. To start the recording, push the Record button.
 - 4.3. To stop the recording, push the Record button again. The recording is automatically saved.
5. To save an image, do the following:
 - 5.1. Turn the mode wheel and select *Camera*.
 - 5.2. To save an image, push the Record button.

3.5 Measure a temperature

Note Temperature measurement functionality is available for radiometric cameras.

1. Add a spotmeter: Tap the menu button at the bottom of the screen. On the main toolbar, select *Measurement > Center spot*.
2. Aim the camera toward the object. Make sure the spotmeter is on the point of interest.
3. Adjust the camera focus. This is very important for a correct temperature measurement.
4. The spotmeter temperature is displayed on the screen.

4.1 View from the front

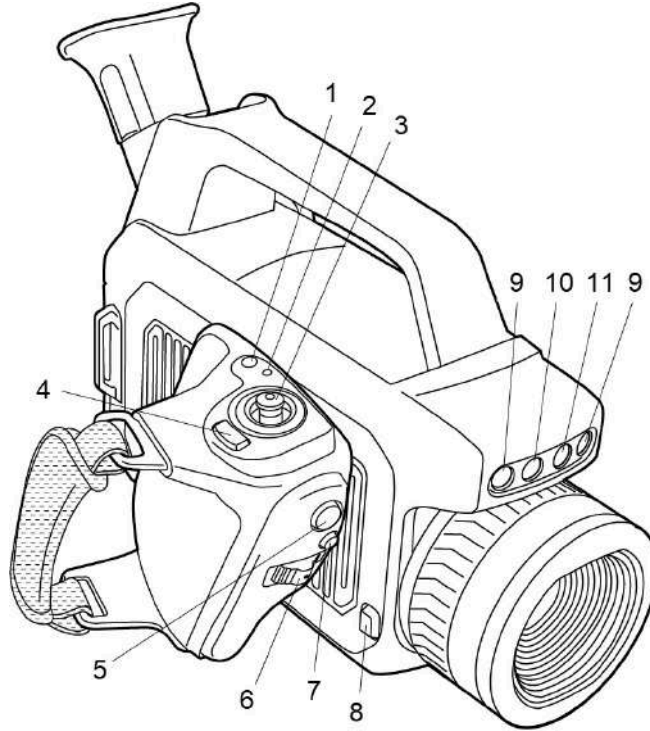

1. On/Off button
2. Power indicator
3. Joystick
4. Back button
5. Record button
6. Focus/Zoom button
FLIR Gx models: Zoom button
7. Programmable button
8. Lens release button
9. Camera lamps
10. Digital camera
11. Laser pointer

4.2 View from the rear

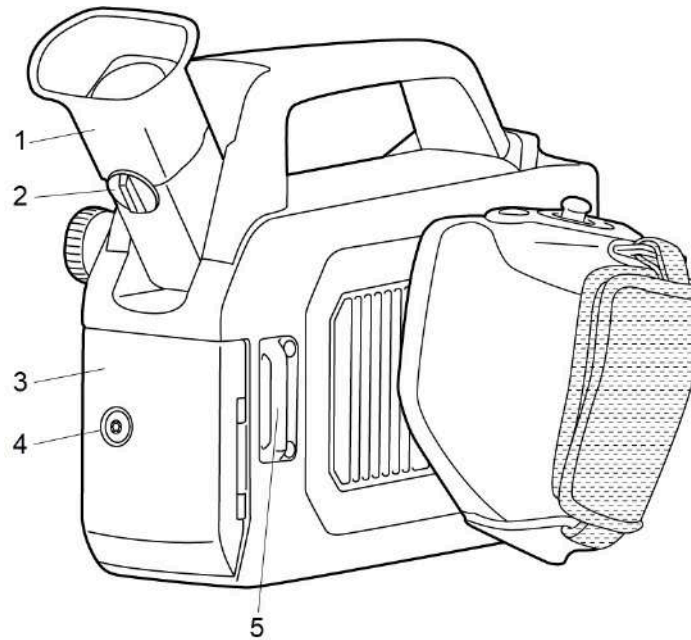

1. Viewfinder
2. Diopter adjustment knob
3. Cover for the connector and battery compartment
4. Locking screw (Torx T20)
5. Attachment point for the neck strap

4.3 View from the left

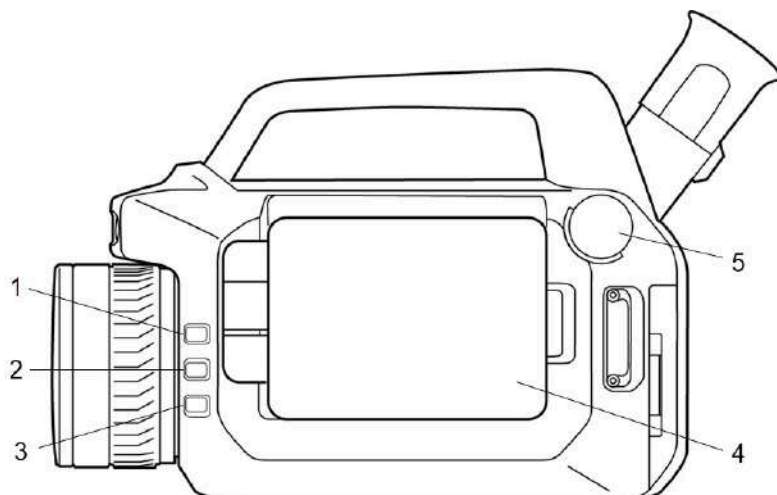

1. Laser button
2. Programmable button
3. Temperature range button
4. Display
5. Mode wheel

4.4 Connector and battery compartment

You can connect the following external devices to the camera:

- A computer, connected using a USB cable, for file transfer and video streaming.
- A video monitor or projector, connected using an HDMI cable.
- An SD memory card.
- Power supply, to charge the battery.

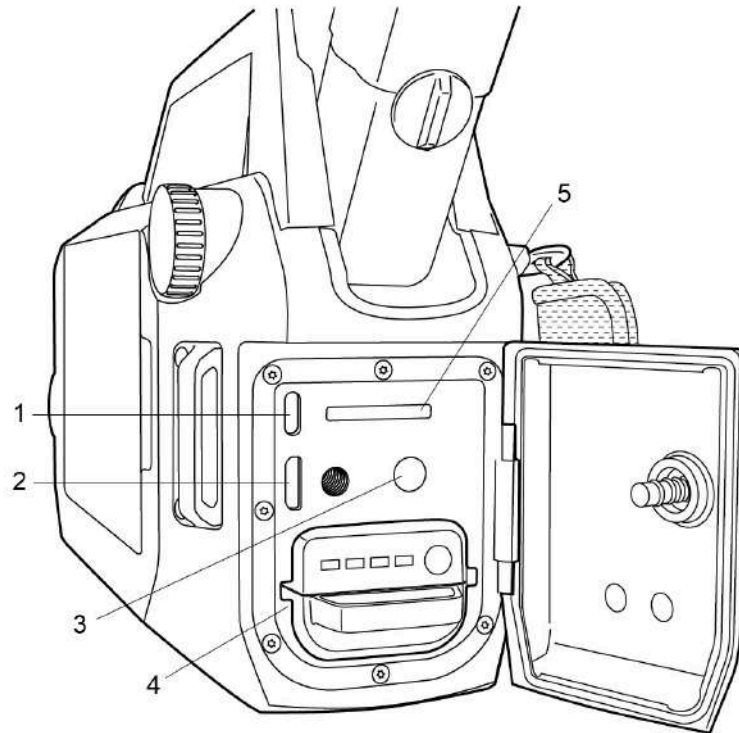

1. USB port
2. HDMI port
3. Power connector
4. Battery
5. Memory card slot

4.5 Serial number

The serial number is available at the inside of the cover for the connector and battery compartment.

The serial number is also available in the camera settings. Select *Settings > Device settings > Camera information*.

4.6 Laser pointer

This figure shows the difference in position between the laser pointer and the optical center of the lens. The laser pointer and the optical axis are parallel.

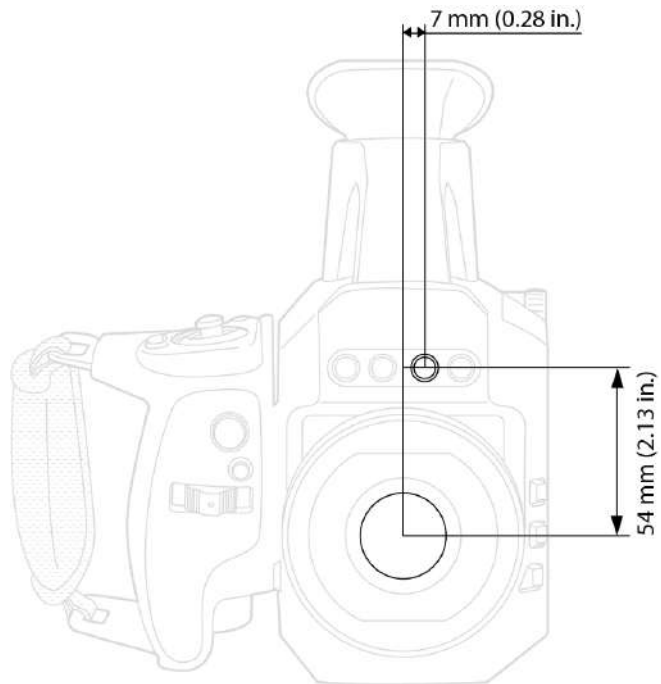









5.1 Screen elements

5.1.1 General



1. Result table
2. Status icons and indicators
3. Spotmeter
4. Temperature scale
5. Menu button

5.1.2 Status icons and indicators

	Battery level <ul style="list-style-type: none"> • Green: above 75% • Yellow: up to 75% • Red: up to 25% • No color: below 15%
	The available storage space on the memory card is running low.
	The GPS is enabled. If the icon is grey, the camera cannot find a GPS signal.
	External infrared window compensation is enabled.
	The camera is paired with a FLIR Ignite account.
	The camera is paired, but does not have contact with FLIR Ignite (no internet connection).
	A Bluetooth headset is connected.
	The laser is on.

5.2 Mode selection menu

The camera can operate in different modes. You select the mode on the Mode selection menu.

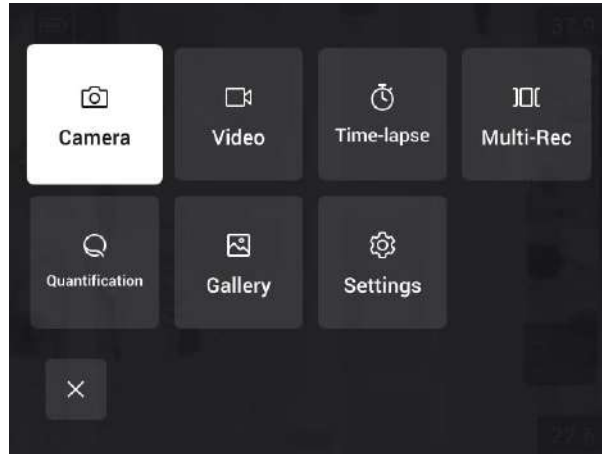

Figure 5.1 Mode selection menu

- Camera: Save images using the Record button.
- Video: Record videos using the Record button.
- Time-lapse: Save images periodically.
- Multi-Rec: Save recordings of video sequences in different image modes. See also section 12.3 *Multi-Rec*.
- Quantification: Measure and quantify a gas leak. See also section 9 *Quantification*.
- Gallery: Video and image archive.
- Settings: Open the *Settings* menu.

Note The availability of the features on the Mode selection menu depends on the camera model.

5.2.1 Navigation

To display and navigate the Mode selection menu, turn the mode wheel. Wait a short while and the camera will enter the highlighted mode.

Note You can also display the Mode selection menu from the main toolbar, and navigate by using the joystick or touch screen.

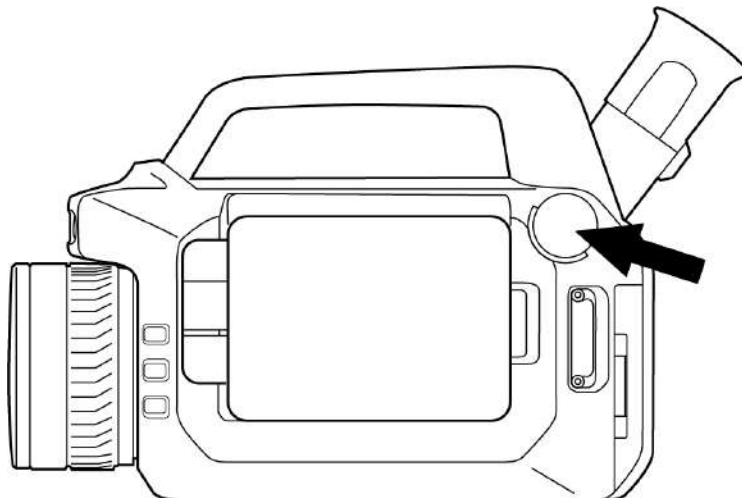
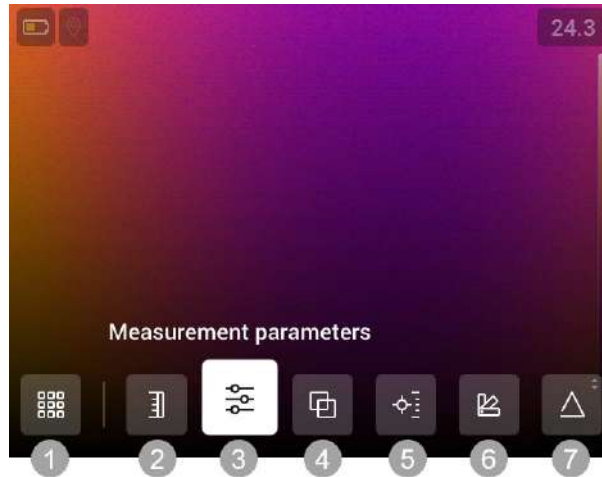

Figure 5.2 Mode wheel

5.3 Main toolbar



1. Mode selection
2. Temperature scale
3. Measurement parameters
4. Image mode
5. Measurement
6. Color
7. Delta T

5.3.1 Navigation

To navigate the user interface, you can use the touch screen and/or the joystick and Back button.

- To display the main toolbar, do one of the following:
 - Tap the menu button at the bottom of the screen.
 - Push the joystick.
- To navigate the toolbars, menus, and dialog boxes, and to change values in dialog boxes, move the joystick up/down or left/right.
- To confirm changes and settings in menus and dialog boxes, push the joystick.
- To leave dialog boxes and to go back in the menu system, push the Back button.

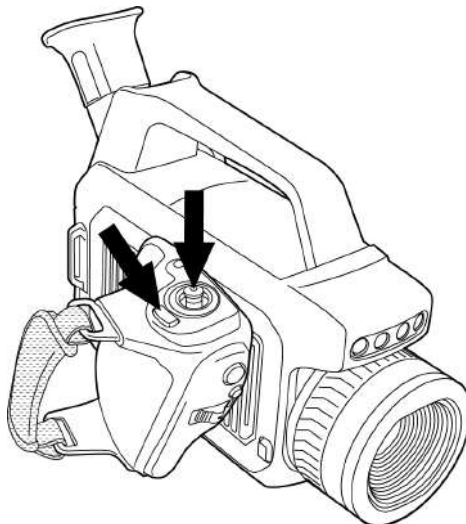

Figure 5.3 Back button and joystick.

5.4 Quick menu



Figure 5.4 Quick menu

1. Storage status of the memory card.
2. Battery level.
3. Enable/disable Bluetooth or open the Bluetooth settings menu. See also section 14.2 *Bluetooth*.
4. Enable/disable Wi-Fi or open the Wi-Fi settings menu. See also section 14.1 *Wi-Fi*.
5. Enable/disable automatic upload of images and videos. See also section 14.3.5 *Automatic upload*.

Note If the camera is not paired with a FLIR Ignite account, you will be prompted to sign in to FLIR Ignite before you can enable automatic upload.

6. Turn on/off the camera lamps.

Note Before you can turn on the camera lamps, you need to enable the lamps. On the *Settings* menu, select *Device settings* > *Lamp & laser* > *Enable lamp & laser* or *Enable lamp & laser + Use lamp as flash*.

7. Adjust the brightness of the screen.
8. The FLIR Ignite user account that the camera is paired with. For more information, see section 14.3.4 *Pair with FLIR Ignite*.
9. Storage status of the FLIR Ignite account.

5.4.1 Navigation

To display the Quick menu, swipe down from the top of the screen.

To navigate the Quick menu by using the touch screen, do the following:

- Tap to enable/disable a function.
- *Bluetooth* and *Wi-Fi*: Tap and hold to open the settings menu.
- Screen brightness: Tap the screen to adjust the screen brightness.

To navigate the Quick menu by using the joystick, do the following:

- Move the joystick up/down or left/right to highlight a function.
- Push the joystick to enable/disable the highlighted function.
- *Bluetooth* and *Wi-Fi*: Push and hold the joystick to open the settings menu.
- Screen brightness: Move the joystick up/down to adjust the screen brightness.

5.5 Image overlay



The camera saves the image information such as date, time, and items related to temperature measurements to the image file. This image information can be viewed in the image archive.

You can also choose to display selected image information items, and also lens information, as an overlay on the image. All image overlay information displayed on the live image will also be displayed on saved images.

To define what image overlay information to display, select *Settings > Device settings > Display settings > Image overlay information*.

6.1 Safety information

Before operating the camera, you must read, understand, and follow the warnings and cautions in the *Safety information* publication.

For the FLIR Gx models, there is a dedicated *Safety information* publication, including warnings and cautions related to explosive and hazardous locations.

The *Safety information* publication is supplied with the camera. It is also available at the following internet address: <https://support.flir.com/resources/b9rp>.

6.2 Battery

6.2.1 Install the battery

Note Use a clean, dry cloth to remove any water or moisture on the battery before you install it.

1. Open the cover at the rear of the camera.
2. Push the battery into the battery compartment.

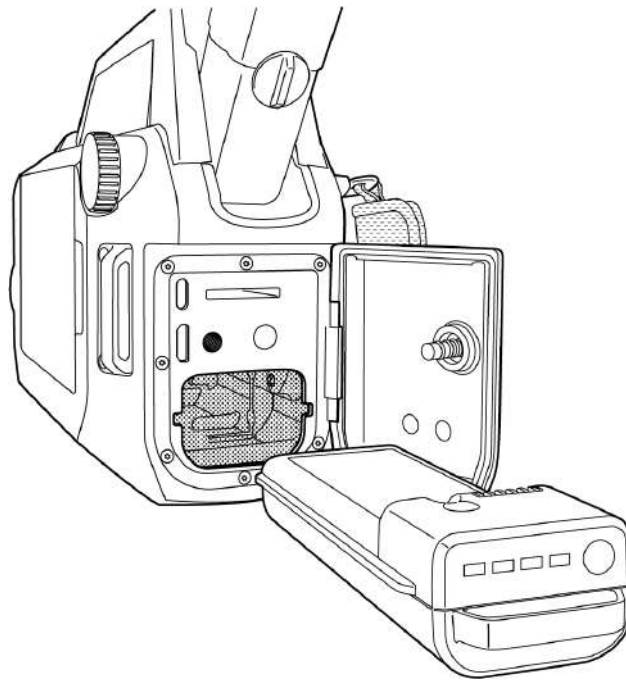

3. Close the cover. Tighten the screw.

6.2.2 Remove the battery



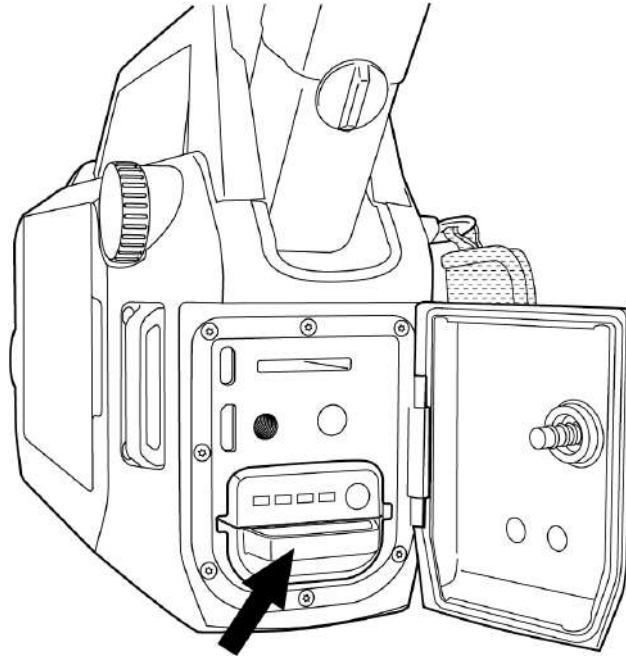

1. Power off the camera.
2. Open the cover at the rear of the camera.
3. Use the handle to pull out the battery.

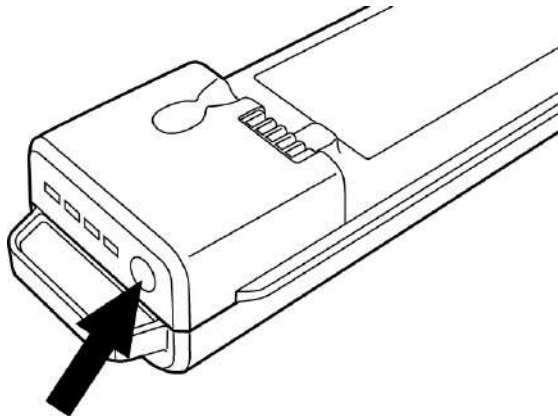

6.2.3 Battery indicator



To check the battery level, push the button. The lights indicate the battery level.

Indicator lights	Battery level
	below 10%
	up to 60%
	up to 90%
	above 90%

See also section 6.3.1 *Battery indicator — charging*.

6.3 Battery charging

You can charge the battery by using the battery charger and its power supply. When the battery is in the camera, you can charge the battery by connecting the power supply to the camera.

**CAUTION**

When you connect the power supply to a mains socket, select a socket that is easy to access. Should a hazardous situation occur, you must be able to easily disconnect the power supply.

Note It is good practice to disconnect the power supply from the mains socket when not in use.

6.3.1 Battery indicator — charging

During the charging, the battery lights indicate the battery level and the last light is flashing.

When the battery is fully charged, all lights are steady on for 15 minutes and then turn off.

6.3.2 Charge the battery using the battery charger

1. Put the battery in the battery charger.
2. Connect the power supply to the battery charger.
3. Connect the power supply to a mains socket.

6.3.3 Charge the battery in the camera

1. Open the cover at the rear of the camera.
2. Connect the power supply cable to the power connector in the camera.
3. Connect the power supply to a mains socket.
4. When the charging is completed, disconnect the power supply from the camera.
5. Close the cover. Tighten the screw.

6.4 Power on/off

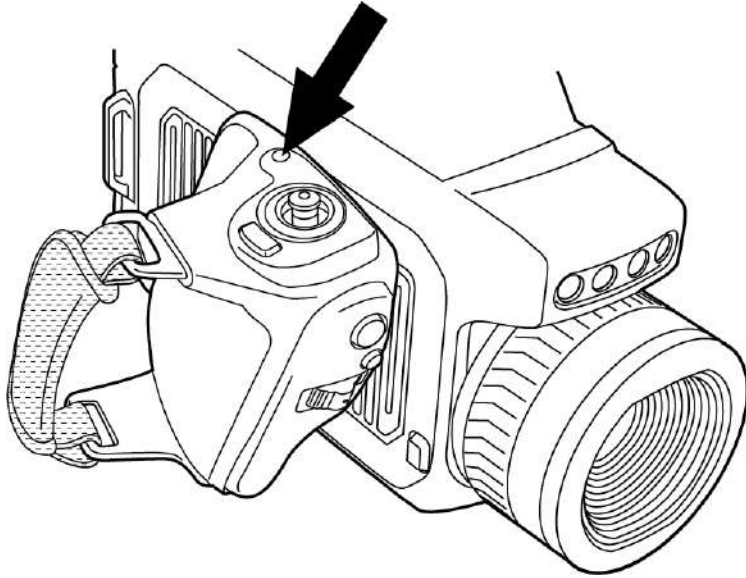

Figure 6.1 On/Off button

6.4.1 Power on

To power on the camera, push the On/Off button.

Note

- When you power on the camera, a mechanical cooler starts to cool down the thermal detector. The loud cooler sound is fully normal. When the cooling procedure is completed, there is a distinct change of the sound.
- The cooling procedure typically takes several minutes. At high ambient temperatures the cooling time may be much longer.

6.4.2 Power off

To power off the camera, push and hold the On/Off button.

Note Do not remove the battery to power off the camera.

6.5 Display

You can unfold the display and adjust the viewing angle to fit your work position.

It is possible to close the display with the screen facing inwards or outwards.

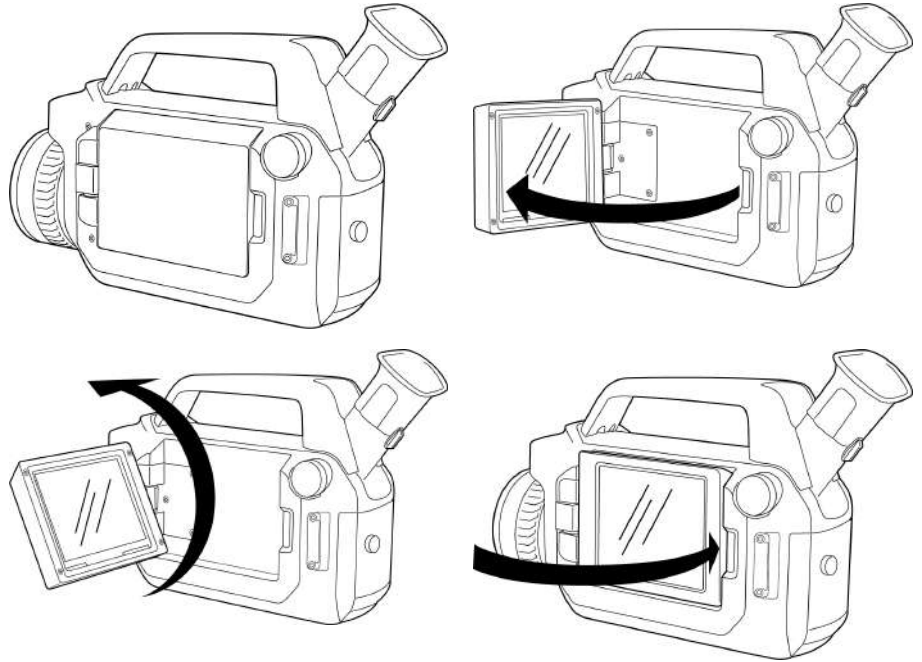

6.6 Viewfinder

Note Before you can use the viewfinder, you must close the display with the screen facing inwards.

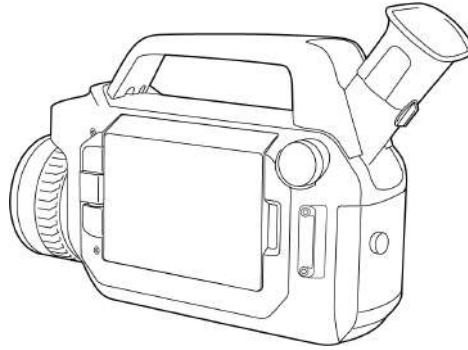

To adjust the viewing angle of the viewfinder, tilt the viewfinder up or down.

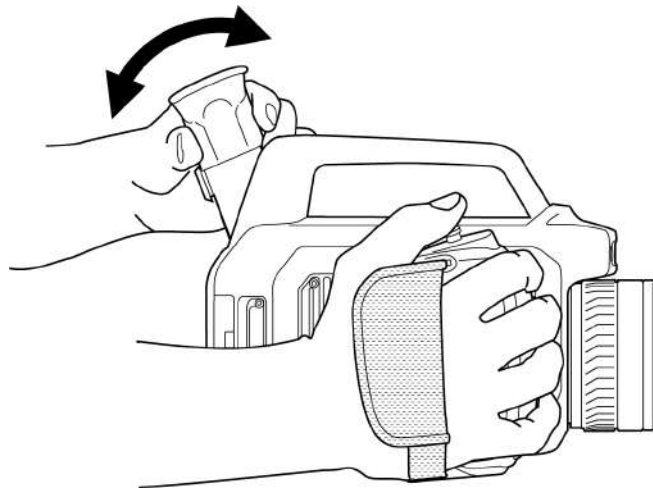

To adjust the viewfinder for your eyesight, look through the viewfinder and turn the diopter adjustment knob for best sharpness.

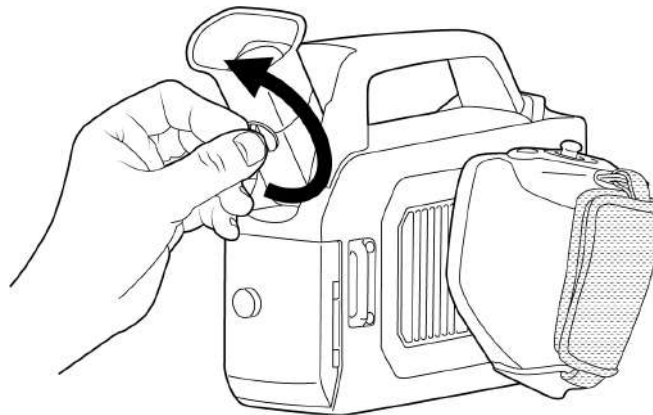

6.7 Ergonomics

To make your working position as comfortable as possible and to prevent overstrain injuries, it is important that you hold the camera correctly.

- Always adjust the camera grip, viewfinder, and display to fit your work position.
- When you hold the camera, make sure you support the camera housing with your left hand too. This decreases the strain on your right hand.

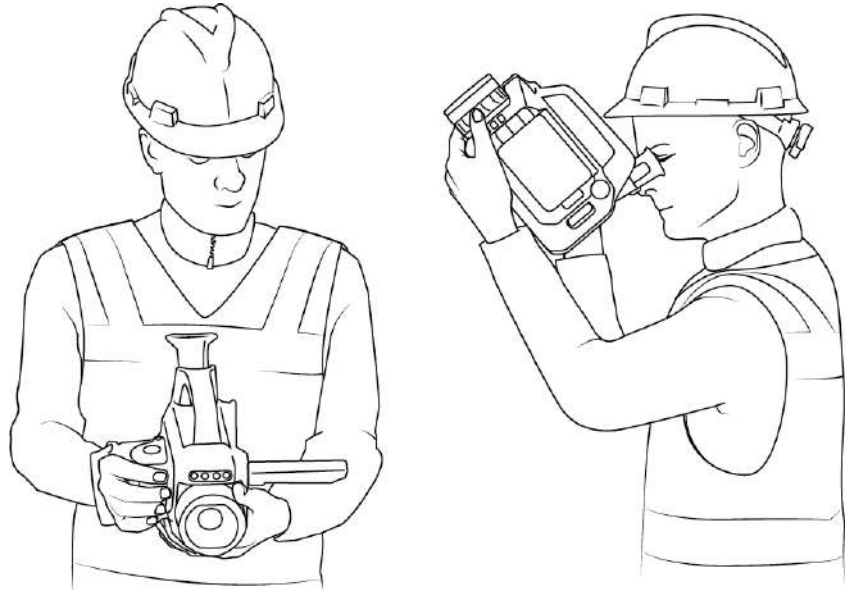

6.8 Focus

6.8.1 Manual focus

To adjust the focus manually, rotate the focus ring.

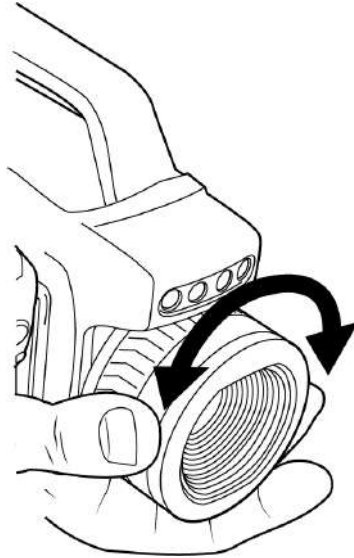

Note Make sure you do not touch the lens surface. Should this happen, clean the lens according to the instructions in section 17.2.2 *Infrared lens*.

6.8.2 Autofocus

Note This feature is not applicable to the FLIR Gx models.

To autofocus, push the center of the Focus/Zoom button.

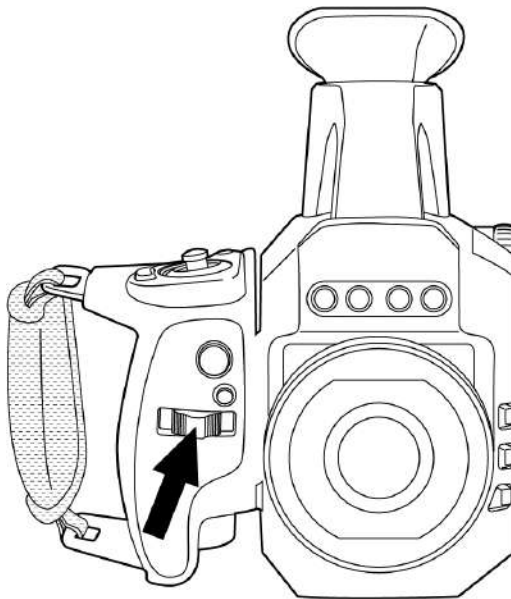

Figure 6.2 Focus/Zoom button

6.9 Temperature range

The camera is calibrated for different temperature ranges. The available temperature range options depend on the camera model.

To change the temperature range, do the following:

1. Push the Temperature range button. This displays the available temperature range options on the screen.
2. Do one of the following:
 - Move the joystick up/down to select a temperature range. Push the center of the joystick to confirm.
 - Tap the desired temperature range on the screen.
3. Wait a short while and the camera will apply the selected temperature range.

Note You can also change the temperature range on the *Settings* menu.

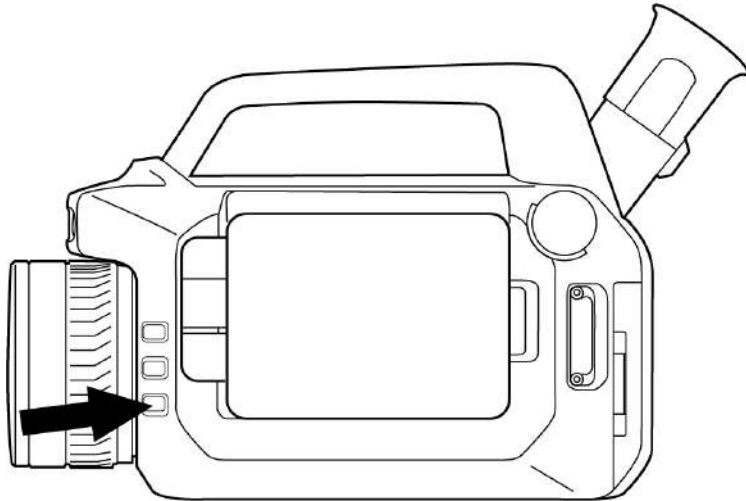

Figure 6.3 Temperature range button

6.10 Mode wheel

The camera can operate in different modes. You select the mode on the Mode selection menu.

To display and navigate the Mode selection menu, turn the mode wheel. Wait a short while and the camera will enter the highlighted mode.

Note You can also display the Mode selection menu from the main toolbar, see section 5.3 *Main toolbar*.

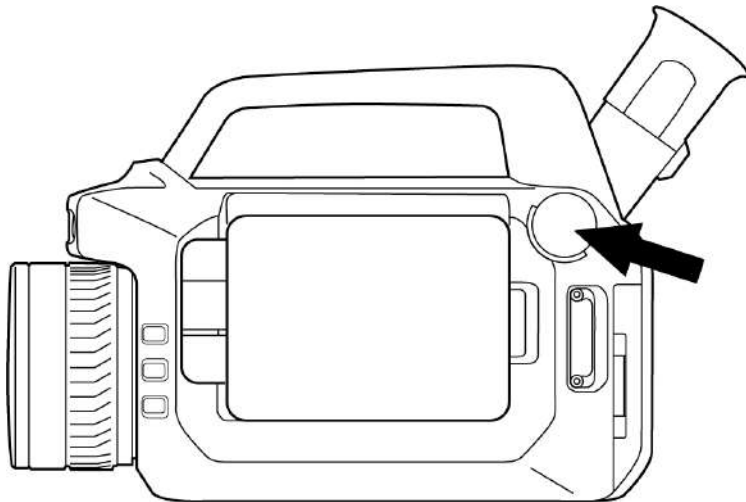

Figure 6.4 Mode wheel

6.11 Save and record

You can save images and record videos by pushing the Record button.

The function of the Record button depends on the selected camera mode.

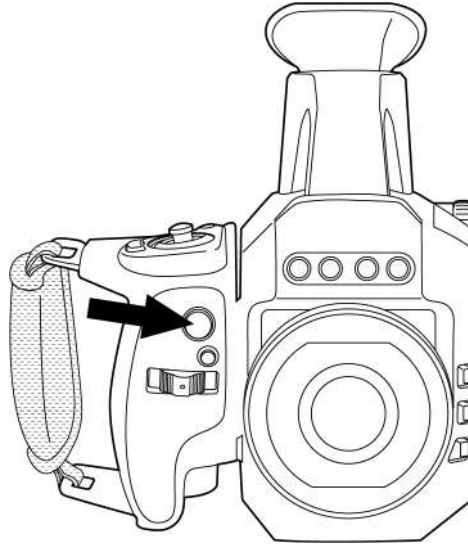

Figure 6.5 Record button

6.11.1 Save an image

1. On the Mode selection menu, select *Camera*.
2. To save an image, push the Record button.

6.11.2 Record a video

1. On the Mode selection menu, select *Video*.
2. To start the recording, push the Record button.
3. To stop the recording, push the Record button again. The recording is automatically saved.

6.12 Zoom

You can digitally zoom an image by using the touch screen or the Focus/Zoom button.

To adjust the zoom, do one of the following:

- On live, preview, and saved images: Place two fingers on the screen and pinch in or stretch out.
- On preview and saved images: Push the Focus/Zoom button left/right.

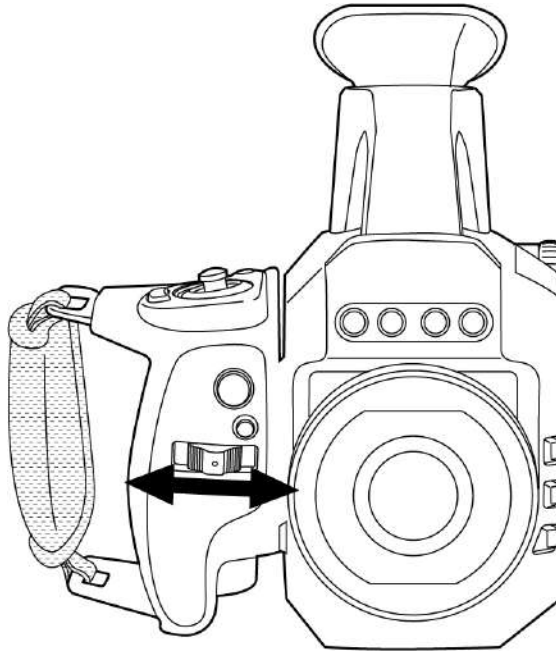

Figure 6.6 Focus/Zoom button

6.13 Programmable buttons

There are two individually programmable buttons.

You can assign different functions to the programmable buttons. You can, for example, use one programmable button to easily activate the High Sensitivity Mode (HSM) and the other to switch between automatic and manual image adjustment modes.

To assign a function to a programmable button, do the following:

1. Push and hold the programmable button. This displays a menu with the programmable button options.
2. Do one of the following:
 - Move the joystick up/down to select a function. Push the center of the joystick to confirm.
 - Tap the desired function on the screen.
3. Wait a short while and the camera will assign the selected function to the button.

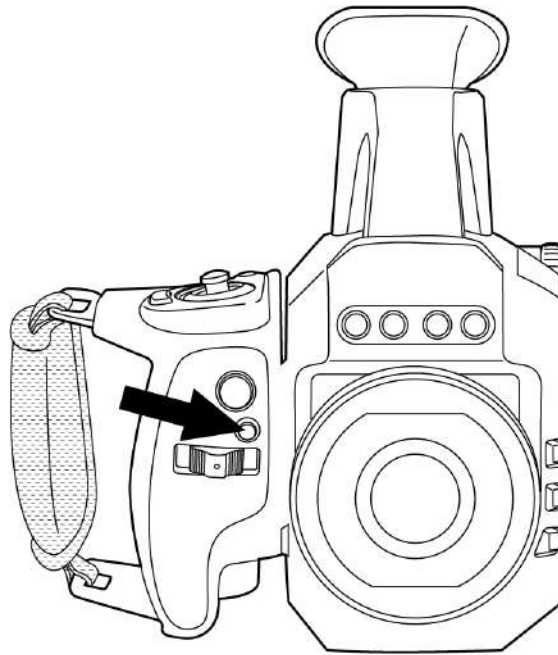

Figure 6.7 Programmable button

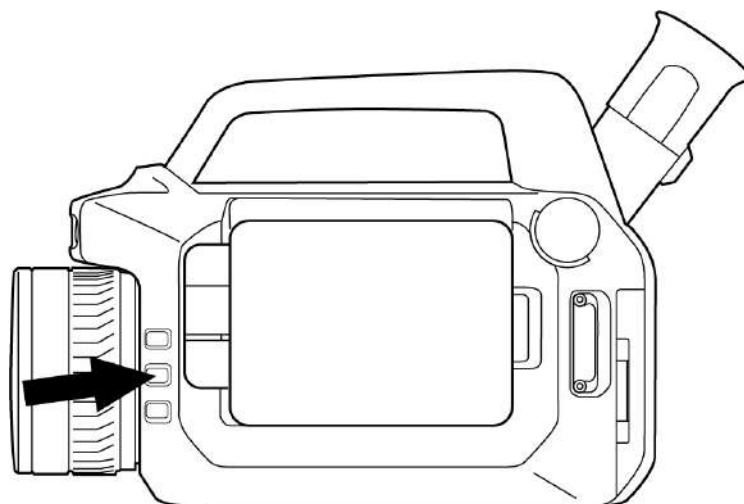



Figure 6.8 Programmable button

6.14 Laser pointer

	WARNING
Class 2 Laser Product	
Do not stare directly into the laser beam. The laser beam can cause eye irritation.	

The camera has a laser pointer. When the laser pointer is on, you will see a laser dot approximately at the target.

Note The laser is enabled by a setting. On the *Settings* menu, select *Device settings > Lamp & laser > Enable lamp & laser*.

To operate the laser pointer, do the following:

- To turn on the laser pointer, push and hold the Laser button.
- To turn off the laser pointer, release the Laser button.

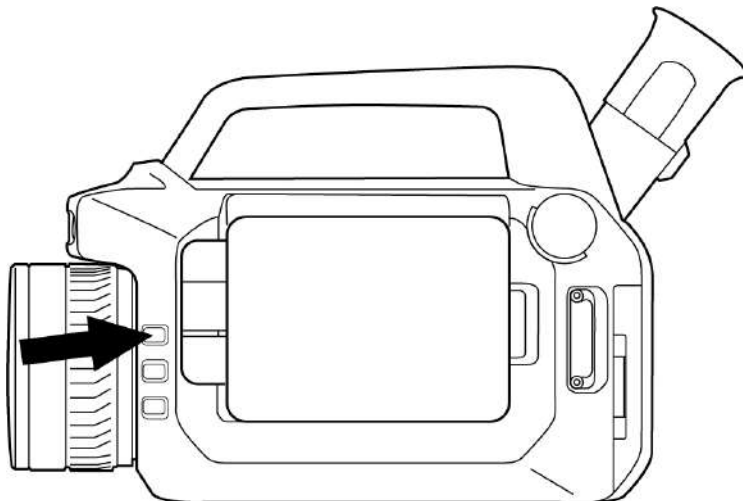

Figure 6.9 Laser button

6.15 File transfer

When you save a video or image, the camera stores the file in the image archive on the memory card.

You can transfer the files from the camera using one of the following methods:

- Connect the camera to a computer with a USB cable.
- Insert the memory card into a computer.
- Upload the files to cloud storage, see section 14.3 *Cloud connectivity*.
- Upload the files via the camera web interface, see section 14.4 *Camera web interface*.

6.15.1 Transfer files via USB cable

1. Open the cover at the rear of the camera.
2. Connect the camera to the computer with a USB cable.
3. Power on the camera.
4. Move the files to the computer using a drag-and-drop operation.

Note This does not delete the files in the camera.

6.16 Camera lamps

You can use the camera lamps as a flash for the digital camera and as a flashlight.

The flash function is enabled by a setting.

To use the camera lamps as a flashlight, do the following:

1. On the *Settings* menu, select *Device settings* > *Lamp & laser* > *Enable lamp & laser* or *Enable lamp & laser + Use lamp as flash*.
2. To turn on the lamps, swipe down from the top of the screen and use the Quick menu.

6.17 Knob screw

Note Not available for FLIR Gx models.

The camera is delivered with a Torx T20 locking screw for the rear cover. For easier access to the connector and battery compartment, you can replace the Torx T20 with the supplied knob screw.

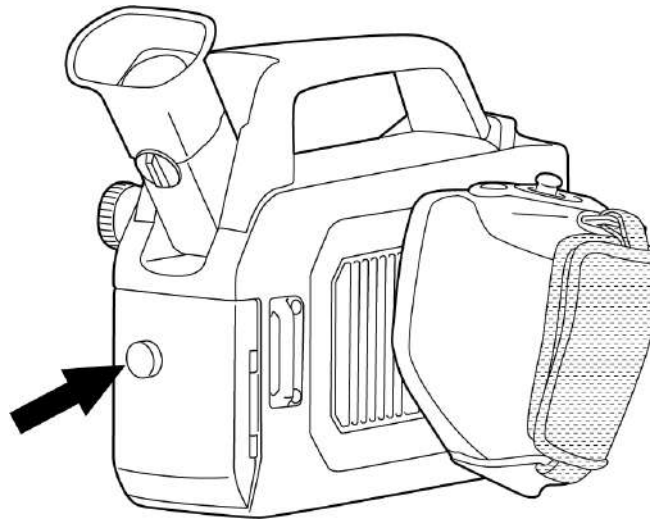

6.18 Change the lenses

Note

- Before a new lens can be used with the camera, the lens–camera combination must be calibrated. This is a process that has to be performed by a FLIR service department.
- When you have removed the lens, put the lens caps on the lens to protect it from dust and fingerprints.
- Make sure you do not touch the lens surface. Should this happen, clean the lens according to the instructions in section 17.2.2 *Infrared lens*.

To change lenses, do the following:

1. Take a firm grip around the outermost part of the lens. Push the release button and rotate the lens counter-clockwise until it stops.

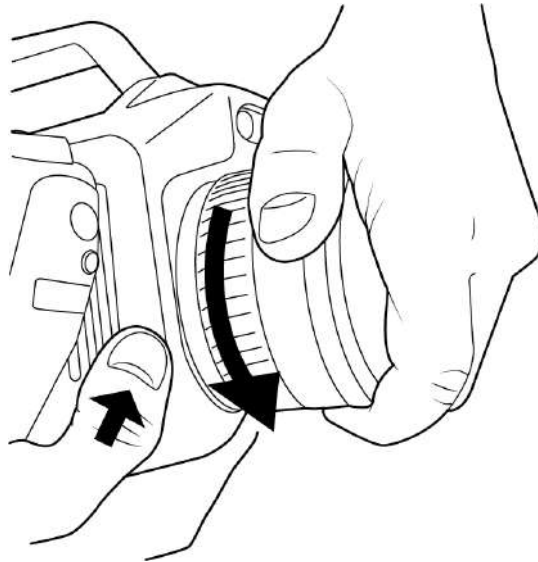

2. Carefully pull out the lens from the bayonet mount.

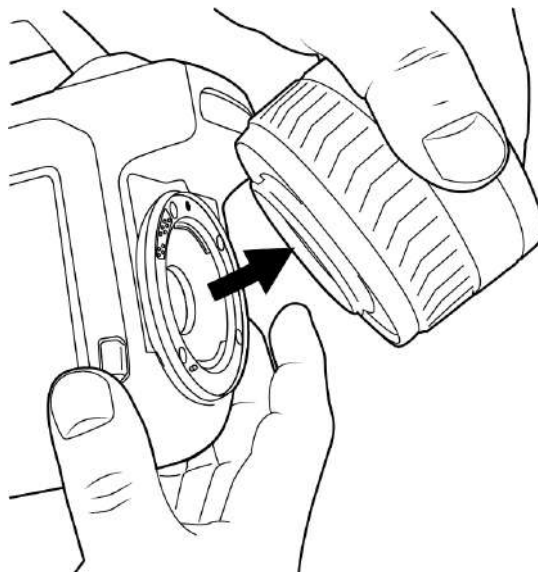

-
3. The thermal detector is now fully exposed. Do not touch this surface.
If you see dust on the detector, follow the instructions in section 17.2.3 *Infrared detector*.

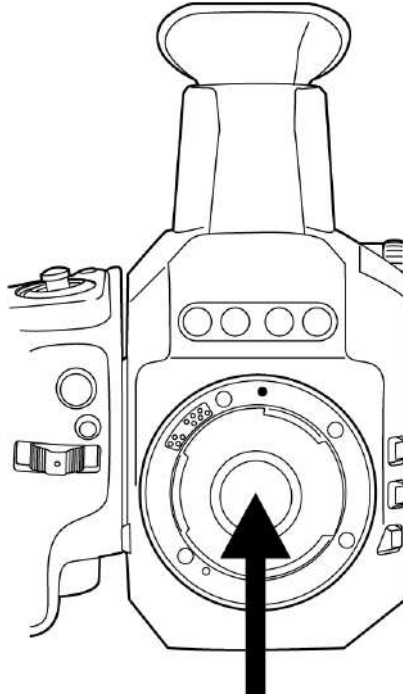

4. Note the index marks on the bayonet mount and on the lens.

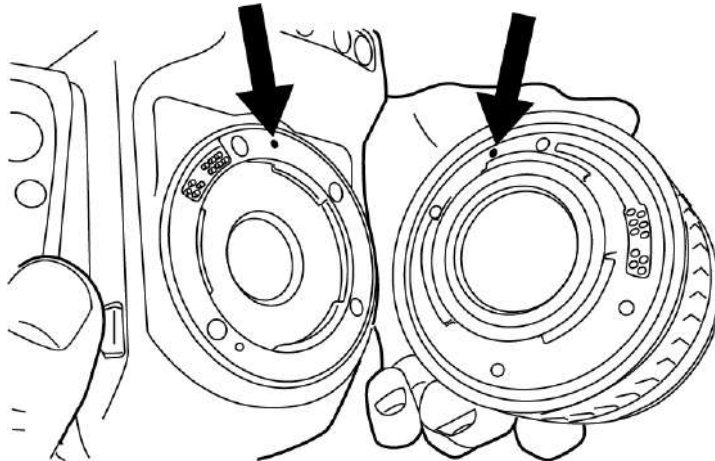

5. Align the lens to the bayonet mount. Carefully push the lens into position.

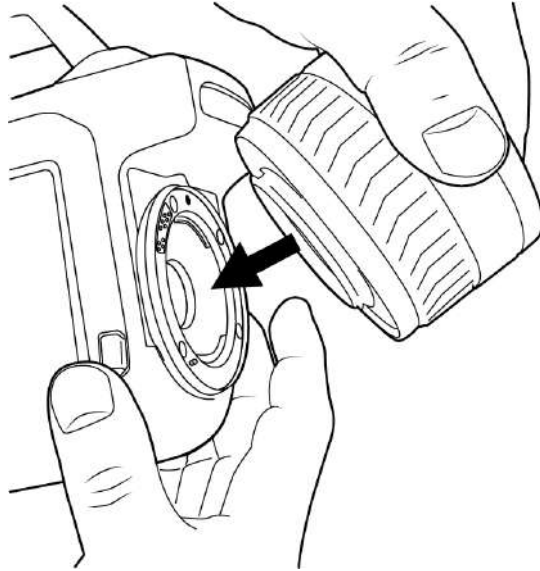

6. Rotate the lens clockwise. The lens makes a click when it locks in place.

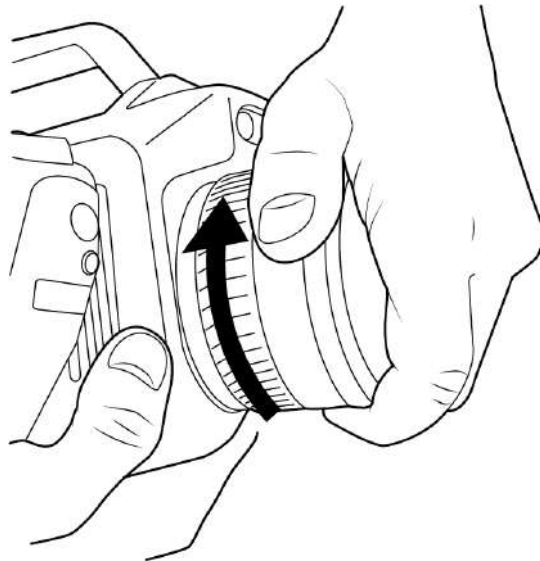

6.19 Attach the heat shield

Note Attach the mounting sleigh assy to the camera before you are on site. The mounting sleigh assy can be left on the camera after it has been mounted.

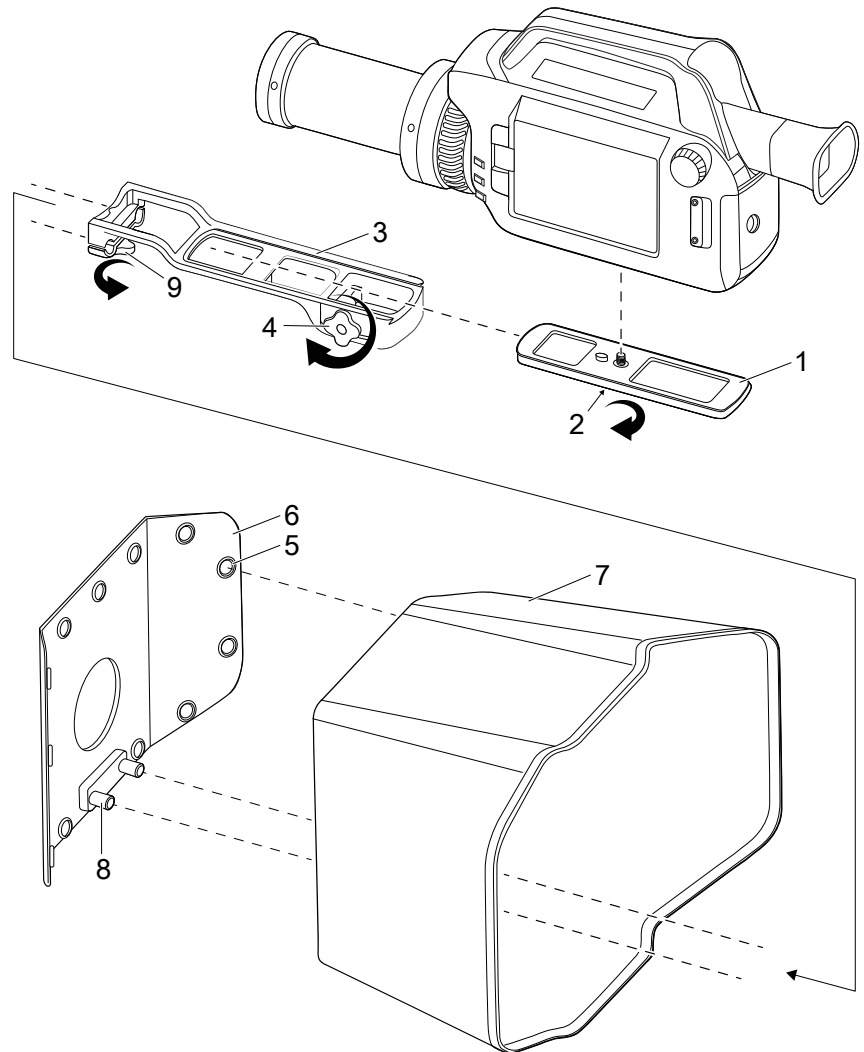

1. Mount the mounting sleigh assy (1) to the bottom of the camera.
2. Tighten the screw (2).
3. Slide the mounting sleigh assy (1) onto the heat shield bracket assy (3).
4. Tighten the knob (4).
5. Attach the press studs (5) from the heat shield assy (6) to the heat shield skirt (7).
6. Slide the heat shield skirt (7) with the attached heat shield assy (6) over the camera.
7. Mount the heat shield bracket assy (3) to the pins (8) on the heat shield assy (6).
8. Tighten the knob (9).

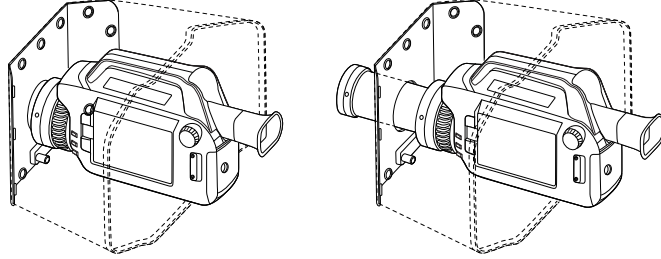

Heat shield mounted on camera for the 6° lens and heat shield mounted for the furnace lens.

7.1 Focus

It is very important to adjust the focus correctly. If the camera is out of focus, there is risk of missing a gas leak. Incorrect focus adjustment also affects the temperature measurements.

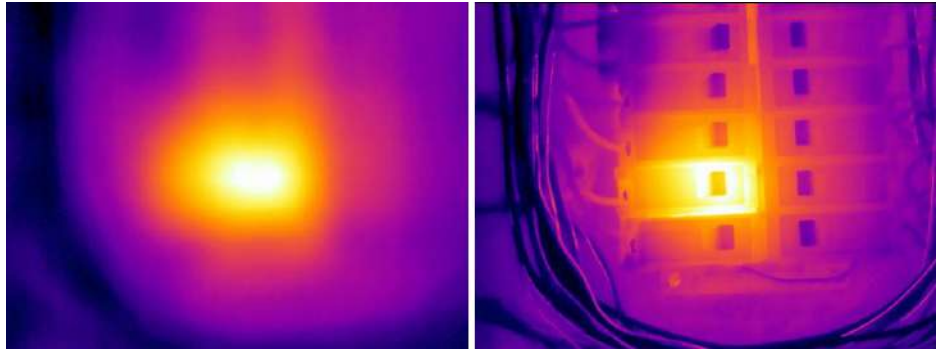

Figure 7.1 In the unfocused image (left), you can only see a diffuse hotter area. The focused image (right) clearly shows which object is being observed and where the object is warm.

A focused and sharp image makes the object and heat pattern easy to recognize. A blurred image not only makes it harder to identify the object and any faults, but can also lead to measurement errors which are more serious the smaller the measurement object. Even if all other parameters are set correctly, the measurement values from an unfocused thermal image are highly likely to be incorrect.

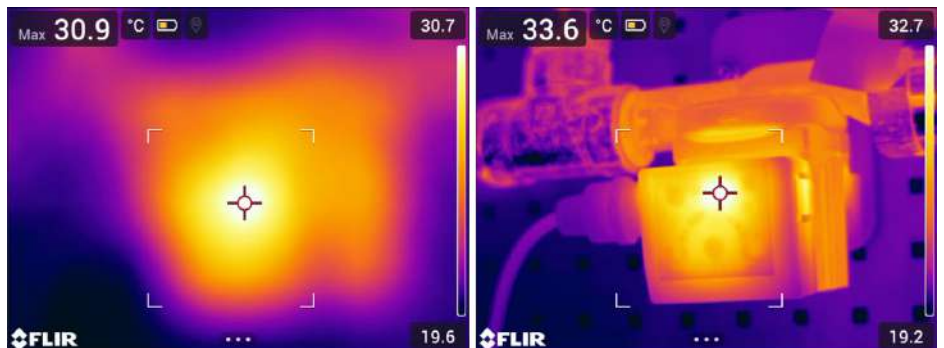

Figure 7.2 The measured temperature is higher in the focused image than in the unfocused image.

7.1.1 Adjust focus

You can adjust the focus manually by using the focus ring, or autofocus by pushing the center of the Focus/Zoom button. See also section 6.8 *Focus*.

Note Applicable to the FLIR Gx models: You can only adjust the focus manually by using the focus ring.

7.2 Temperature range

The camera is calibrated for different temperature ranges. The available temperature range options depend on the camera model.

The temperature range setting has an impact on the sensitivity of the camera and on the integration (exposure) time. What temperature range to select depends on the thermal conditions in the scene.

If the selected temperature range is too low, the image will be oversaturated, as objects with higher temperatures emit more thermal radiation than colder objects. If you select a temperature range that is too high, the thermal image will be “underexposed”.

A general guideline for gas detection is to start with the lowest camera temperature range, but change if the image becomes oversaturated.

For accurate temperature measurements, you must select a temperature range that matches the expected temperature of the object you are inspecting.

7.2.1 Change the temperature range

To change the temperature range, do one of the following:

- Push the Temperature range button and then select a temperature range by using the joystick or touching the screen. See also section 6.9 *Temperature range*.
- On the *Settings* menu, select *Camera temperature range*. This displays a menu where you can select the temperature range.

7.3 Thermal image adjustment

Thermal image adjustment, or thermal tuning, means adjusting the temperature scale of a thermal image, in order to maximize the brightness and contrast in the image.

In automatic mode, the camera continuously adjusts the image for the best presentation. The camera selects the coldest and warmest temperatures in the image as the lower and upper limits of the temperature scale. The colors are then distributed over that temperature interval (histogram color distribution).

In manual mode, you can adjust the temperature scale to values close to the temperature of a specific object in the image. The colors are distributed evenly from the lowest to the highest temperature (linear color distribution).

Manual mode lets you center on the temperatures around the background of the gas, which can make the gas appear more clearly.

When measuring temperatures, manual mode will make it possible to detect anomalies and smaller temperature differences in the part of the image of interest.

Note Manual image adjustment is not possible in High Sensitivity Mode (HSM) mode.

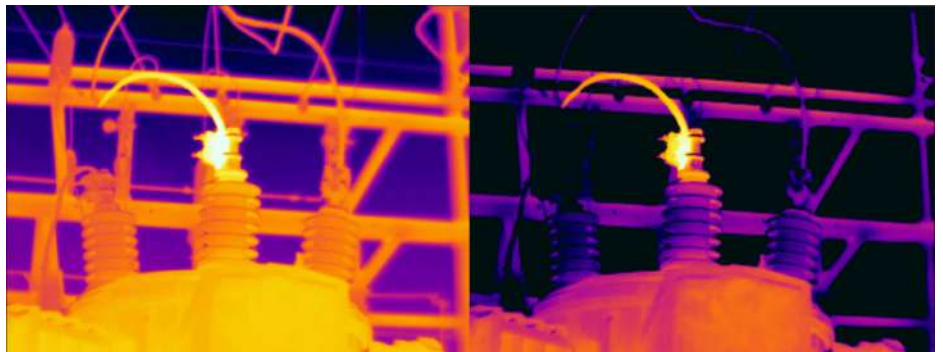

Figure 7.3 A thermal image of a power line in automatic mode (left) and in manual mode (right). To make it easier to analyze the temperature variations in the isolator, the temperature scale in the right image has been changed to values close to the temperature of the isolator.

7.3.1 Manual mode

To enter manual adjustment mode, select *Temperature scale > Manual* on the main toolbar.

In preview/edit mode, manual adjustment mode is active.

Note To easily switch between the automatic and manual adjustment modes, you can assign the function *Switch between auto and manual* to one of the programmable buttons, see section 6.13 *Programmable buttons*.

7.3.2 Manual adjustment by touching the screen

The touch functionality for manual adjustments is enabled by a setting. On the *Settings* menu, select *Device settings* > *User interface options* > *Manual adjustment using touch*.

When manual mode is active, an adjustment wheel is displayed to the right of the temperature scale. (Applicable when the manual adjustment by touch functionality is enabled.)

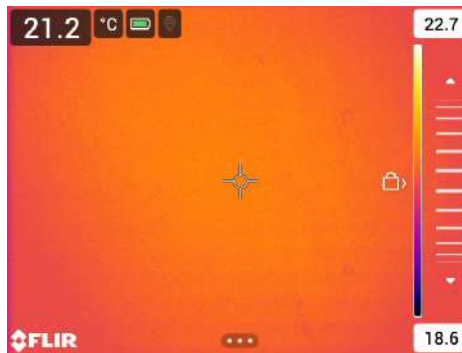

Figure 7.4 Manual adjustment mode active

To manually adjust the image, do the following:

1. To enter manual adjustment mode, select *Temperature scale* > *Manual* on the main toolbar.
2. To simultaneously change the maximum and minimum limits of the temperature scale, place your finger on the screen and move it up/down.
3. To change the maximum or minimum limit, do the following:
 - 3.1. Tap the maximum or minimum temperature.
 - 3.2. Place your finger on the screen and move it up/down to change the value of the highlighted temperature.

7.3.2.1 1-Touch auto-adjustment

In manual mode, you can auto-adjust the image by touching the screen. The image will be auto-adjusted based on the thermal content of the area around the touched point. The top and bottom levels in the temperature scale will be set to the maximum and minimum temperatures in that area.

By using the color information only for the relevant temperatures, you will get more details in your area of interest.

Note You can also assign the function *Auto adjust the manual temperature scale* to a programmable button, see section 6.13 *Programmable buttons*. This allows you to make an automatic adjustment of the image while remaining in manual mode.



7.3.2.2 Lock touch screen

When you have adjusted the image to levels that allow you to study your area of interest, you can lock the touch screen to prevent further unintentional adjustments.

To lock/unlock the screen, tap the icon to the left of the temperature scale.

Note If you switch to automatic mode, the screen automatically unlocks and your manual adjustments are lost.

7.3.3 Manual adjustment using the joystick

7.3.3.1 Manual adjustment modes

There are two different settings for the manual adjustment mode (applicable for the joystick only):

- *Level, Span*: With this setting, you can manually adjust the level and span with the joystick.
- *Level, Max, Min*: With this setting, you can manually adjust the level with the joystick. You can also change the upper and lower temperatures individually.

To change the type of manual adjustment mode, select *Settings > Device settings > User interface options > Manual adjustment mode*.

7.3.3.2 Manual adjustment in Level, Span mode

1. To enter manual adjustment mode, select *Temperature scale > Manual* on the main toolbar.
2. Move the joystick up/down to increase/decrease the level.
3. Move the joystick left/right to increase/decrease the span.

7.3.3.3 Manual adjustment in Level, Max, Min mode

1. To enter manual adjustment mode, select *Temperature scale > Manual* on the main toolbar.
2. To simultaneously change the temperature scale minimum and maximum limits, move the joystick up/down.
3. To change the minimum or maximum limit, do the following:
 - Move the joystick left/right to select (highlight) the maximum or minimum temperature.
 - Move the joystick up/down to change the value of the highlighted temperature.

7.3.4 Auto adjustment region

In automatic mode, the camera distributes the colors over the existing temperatures in the image.

In some situations, the image may contain very hot or very cold areas outside your area of interest. In such cases, you may want to exclude those areas and distribute the colors only over the temperatures in your area of interest. This can be done by selecting a smaller auto adjustment region.

To change the auto adjustment region, select *Settings > Device settings > User interface options > Auto adjustment region*.

7.4 Color palettes

The camera supports a number of different color palettes. Frequently used palettes include the iron, gray, and rainbow palettes.

- The iron palette is intuitive and also easy to understand for those without much experience in thermography. It offers a good balance between geometric and thermal resolution.
- Gray tones are particularly suited to resolving small geometric details, but are less suited to displaying small differences in temperature.
- The rainbow palette is more colorful and alternates between light and dark colors. This results in greater contrast, but this can lead to a noisy image for objects with different surfaces or many temperatures.

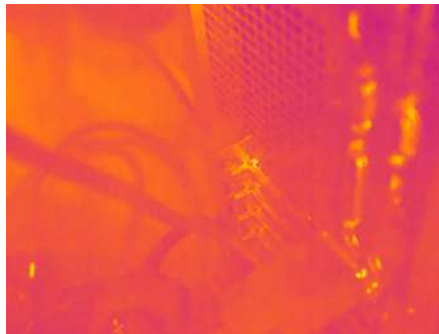

Iron

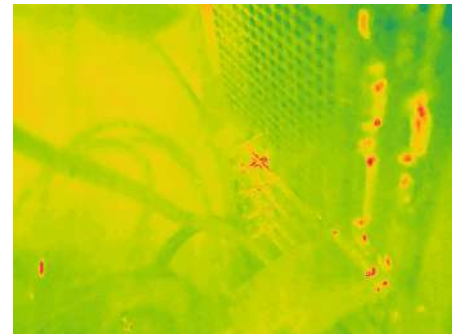

Rainbow



Gray (White hot)



Gray (Black hot)

7.4.1 Change the color palette

On the main toolbar, select *Color*. This displays a toolbar where you can select a color palette.

8.1 Basic steps to gas detection

- First adjust the focus. If the camera is out of focus, there is a risk of missing a gas leak.
- The key to making the gas visible is enhancing the temperature difference between the gas cloud and the background. To obtain optimal contrast, try to find a suitable background by aiming the camera toward the target from different angles.
- Use the Delta T feature to show areas where there is insufficient temperature difference between the background and the gas.
- Using the High Sensitivity Mode (HSM) can improve the detection of gas leaks, especially when they are small or low in concentration.
- By adjusting the temperature scale to temperatures around the background of the gas, you can make the gas appear more clearly.
- Selecting a different color palette can make it easier to see the gas cloud.
- The sensitivity of the camera can be controlled by changing the camera temperature range. A general guideline is to start with the lowest camera temperature range, but change if the image becomes oversaturated.
- Motion of the gas, for example, caused by wind, makes the gas cloud easier to see.

8.2 Adjust the camera focus

It is very important to adjust the focus correctly. If the camera is out of focus, there is risk of missing a gas leak.

You can adjust the focus manually by using the focus ring, or autofocus by pushing the center of the Focus/Zoom button. See also section 6.8 *Focus*.

Note Applicable to the FLIR Gx models: You can only adjust the focus manually by using the focus ring.

8.3 Delta T

A higher temperature differential between the gas plume and the background will make the plume more visible on the camera screen. The background should be at least 2°C (3.6°F) warmer (or colder) than ambient temperature to provide sufficient contrast.

Use the Delta T feature to show areas where there is insufficient delta temperature.

1. On the main toolbar, select *Delta T*. This displays a dialog box.
2. In the dialog box, you can define the Delta T settings:
 - Turn on/off the Delta T feature.
 - *Atmospheric temperature*: The current ambient air temperature in the same general area as the gas leak.

Note This setting is the same as for the measurement parameters, see section 10.5 *Measurement parameters*. Any changes in the *Delta T* dialog will also change the corresponding measurement parameter setting.
 - *Temperature difference*: As a general guideline, set the temperature difference to 2°C (3.6°F).
3. To close the dialog box, push the Back button.

8.4 High Sensitivity Mode (HSM)

High Sensitivity Mode (HSM) is a feature specifically designed for gas detection.

The HSM mode makes motion more visible in the image. This is achieved by comparing the information in two image frames, taken at different times, and removing all information that is the same. What remains will be items that have changed, such as a moving

gas. HSM also amplifies this remaining information, which makes a moving gas cloud stand out more clearly.

It is possible to adjust the sensitivity of HSM in a number of fixed steps, with different combinations of time between the image frames and amplification. A higher sensitivity value will allow you to see smaller variations, but there will also be more noise in the image.

You will need to experiment with the sensitivity until you get a clear image of a verified gas leak.

General guidelines:

- If you believe the gas leak is small or low in concentration, use a high sensitivity value.
- For large gas leaks, use a low sensitivity value.

8.4.1 Using HSM

To activate the High Sensitivity Mode (HSM), select *Image mode > HSM* on the main toolbar.

Note You can also assign the function *Toggle HSM* to a programmable button, see section 6.13 *Programmable buttons*.

When the HSM mode is active, a slider is displayed. Use this slider to change the HSM sensitivity.

To change the sensitivity, do one of the following:

- Move the joystick up/down.
- Drag the slider by touching the screen.

8.5 Adjust the temperature scale

The camera continuously adjusts the temperature scale for the best image presentation. By manually adjusting the scale to temperatures around the background of the gas, you can make the gas appear more clearly.

For instructions on how to manually adjust the temperature scale, see section 7.3 *Thermal image adjustment*.

Note Manual image adjustment is not possible in High Sensitivity Mode (HSM) mode.

8.6 Change the color palette

The camera uses a color palette to display different temperatures. Changing the color palette can make it easier to see the gas cloud.

To change the color palette, select *Color* on the main toolbar.

8.7 Change the temperature range

The sensitivity of the camera can be controlled by changing the camera temperature range. The selected temperature range also has an impact on the integration (exposure) time. The optimal temperature range setting depends on the thermal conditions in the scene.

A general guideline for gas detection is to start with the lowest camera temperature range, which gives the highest sensitivity.

If there are warm objects in the scene, the image may become oversaturated. If this happens, you should change to the next temperature range. With a too low temperature range, you risk to miss a gas passing in front of the warm objects.

To change the temperature range, do one of the following:

- Push the Temperature range button and then select a temperature range by using the joystick or touching the screen. See also section 6.9 *Temperature range*.
- On the *Settings* menu, select *Camera temperature range*. This displays a menu where you can select the temperature range.

Note The availability of this feature depends on the camera model.

9.1 Introduction

Quantitative Optical Gas Imaging (QOGI) extends Optical Gas Imaging (OGI) to provide a quantitative result. While OGI can qualitatively detect the presence of a gas leak, QOGI will quantify the gas leak and provide a measurement of leak rate or concentration.

Quantification mode is specially designed to be used for QOGI applications. The data acquisition and analysis is integrated in the camera and the quantification results are displayed on the camera screen. The results are automatically saved and can also be saved as a pdf.

The camera can be set up to record a radiometric video as part of the quantification measurement. The video file, which also includes the quantification parameters, is automatically saved in the camera. You can transfer the video file with the quantification parameters to another device, such as the FLIR QL320, for further processing.

9.1.1 Field equipment

The plume extraction algorithm is change based, therefore it requires a steady image to separate the plume from the background. This requires the operator to place the camera on a tripod to perform any quantification measurement.

In addition to the tripod, a thermometer and a tape measurer (or infrared range finder) are recommended as the operator will need to provide the ambient temperature and distance from the camera to the leak.

An anemometer is also recommended, though not absolutely required. The operator will provide an estimate of the wind conditions (calm, normal or high), not an exact wind speed measurement.

9.2 User interface



1. Mode selection
2. Parameters
3. Measurements
4. Delta T
5. Start measurement

9.2.1 Quantification parameters

For accurate quantification results, it is important to set the quantification parameters according to the current conditions.

- *Temperature* refers to the temperature of the gas. It is common to use the ambient temperature to represent the gas temperature. The assumption being made is that the gas will quickly equilibrate to ambient temperature, even if there is a pressure drop at the leak source.
- *Wind* refers to the current wind conditions. There are three options: High (> 10 mph), Normal (2-10 mph), and Low (0-1 mph). These general wind conditions are meant to describe the dispersion qualities of the plume being measured. It is not necessary to make an exact wind speed measurement, the setting is rather a description of the general conditions.
- *Leak type* refers to the geometry of the leak. There are two options: Diffuse and Point. A Diffuse leak is one whose source is greater than 5 cm (2 in.) in diameter. An example of a diffuse leak is a thief hatch on a storage tank. A Point leak is one whose source is less than 5 cm (2 in.) in diameter. An example of a Point leak is a fitting on a ¼" tubing.
- *Distance* refers to the distance from the camera to the leak.
- *Gas type* refers to the gas composition being measured.
- *Gas plume* refers to the polarity of the plume being measured. Considering white to be hot, a Black plume will appear colder (or darker) than the background. It is typical to have a Black plume when the apparent temperature of the background is warmer than the ambient temperature. A White plume appears warmer (or brighter) than the background. It is typical to have a White plume when the apparent temperature of the background is colder than ambient temperature.

9.2.2 Type of measurement

The camera allows you to measure both flow rate and concentration. For more information, see section 9.4.6 *Leak rate versus concentration*.

To select the type of measurement, do the following:

1. On the main toolbar, select *Measurement*. This displays a toolbar.
2. On the toolbar, do one of the following:
 - Select *Concentration*. This displays a box on the image and a toolbar where you can do the following:
 - To resize the box, select *Resize box* and push the joystick. Move the joystick up/down and left/right to resize the box.
 - To move the box, select *Move box* and push the joystick. Move the joystick up/down and left/right to move the box.
 - To reset the box to default size and position, select *Reset box*.
 - When completed, select *Done*.
 - Select *Flow rate*. This displays a circle on the image.

9.2.2.1 Delta T

The background should be at least 2°C (3.6°F) warmer (or colder) than the ambient temperature to provide sufficient contrast for quantification. Use the Delta T feature to show areas of the field of view where there is insufficient delta temperature for quantification. Those areas will be highlighted red.

For more information, see sections 9.3.6 *Ensure minimum delta temperature* and 9.4.3 *Assessing delta temperature*.

9.2.2.2 Flow rate unit

To change the flow rate unit, select *Settings > Quantification > Flow rate*.

9.2.3 Radiometric video recording

The camera can be set up to record a radiometric video (*.csq) after the quantification measurement. The video file, which includes the quantification parameters, can be opened and processed on another device, such as the FLIR QL320.

To enable recording of radiometric video (*.csq), select *Settings > Quantification > Save radiometric recording = On*.

9.3 Perform a quantification measurement

In a typical field use, the camera will be used as a hand-held camera to first identify a gas leak. To measure the leak, the operator will select a measurement position and place the camera on a tripod and then perform a quantification measurement.

9.3.1 Main steps

The quantification measurement includes the following main steps:

- Select a measurement position.
- Place the camera.
- Ensure minimum delta temperature.
- Set the quantification parameters.
- Start the measurement.

9.3.2 Select a measurement position

Observe the leak from several positions to find a viewing angle that gives the camera the best measurement position. For more information, see section 9.4.1 *Measurement position*.

9.3.3 Place the camera

1. Set up the tripod at the viewing location you have chosen.
2. Choose the height and location of the tripod to optimize the background as described in section 9.4.1 *Measurement position*.
3. Position the camera so the identified leak location is centered in the camera's Field of View (FOV).
4. Aim the camera so that the gas leak is inside the circle on the screen. Make sure that all gas flows out of the circle. See also section 9.4.5 *Field of view and focus*.
5. Adjust the camera focus so that both the plume and the background are in focus. If this is not possible, priority should be given to the plume. See also section 9.4.5 *Field of view and focus*.
6. Make sure the camera is operating in the proper temperature range. See also section 9.4.4 *Camera temperature range*.

9.3.4 Enter Quantification mode

To enter the Quantification mode, select *Quantification* on the Mode selection menu.

9.3.5 Set the quantification parameters

Before each measurement it is important to check and set the quantification parameters according to the current conditions.

9.3.5.1 Measure parameters

Measure the ambient temperature every time a quantification measurement is performed. For more information, see section 9.4.2 *Measure Ambient Temperature*.

9.3.5.2 Enter parameters

For accurate quantification results, it is important to set the quantification parameters according to the current conditions. For more information, see section 9.2.1 *Quantification parameters*.

To enter the quantification parameters, do the following:

1. On the main toolbar, select *Parameters*. This displays a toolbar.
2. On the toolbar, select a parameter. This displays a dialog box, where you can change the parameter value.
3. To close the dialog box, push the Back button.

9.3.6 Ensure minimum delta temperature

The background should be at least 2°C (3.6°F) warmer (or colder) than the ambient temperature to provide sufficient contrast for quantification. For more information, see section 9.4.3 *Assessing delta temperature*.

Use the Delta T feature to show areas where there is insufficient delta temperature for quantification.

1. On the main toolbar, select *Delta T*. This displays a dialog box.
2. In the dialog box, you can define the settings:
 - Turn on/off the Delta T feature.
 - *Atmospheric temperature*: The current ambient air temperature in the same general area as the gas leak.

Note This setting is the same as for the measurement parameters, see section 10.5 *Measurement parameters*. Any changes in the *Delta T* dialog will also change the corresponding measurement parameter setting.
 - *Temperature difference*: Set the temperature difference to 2°C (3.6°F).
3. To close the dialog box, push the Back button.

9.3.7 Start the measurement

Note Do not move or shake the camera while measuring the gas. This will ensure a better measurement result.

To start and run the measurement process, do the following:

1. On the main toolbar, select *Start measurement*.
2. The camera displays the progress on the screen.

If video recording is enabled, a red dot is displayed while the recording is in progress.
3. When the measurement and documentation are completed, you can select to view a summary of the quantification result.

The quantification results are automatically saved to the memory card.

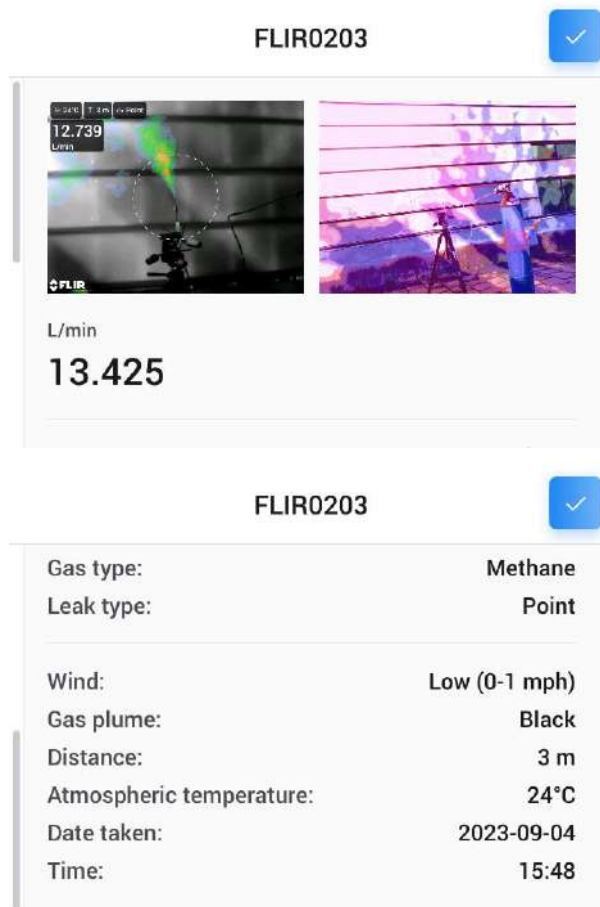

Figure 9.1 Summary of the quantification result

9.3.8 Quantification results

The camera saves the quantification results in the active folder in the image archive.



The following files are saved:

- Thermal image, including a summary of the quantification result.
- Visual image.
- If recording is enabled: Video (*.csq) file, including the quantification parameters. For further processing, transfer the video (*.csq) file to another device, such as the FLIR QL320.

9.3.8.1 View summary



The quantification thermal image includes a summary of the quantification result.

To view the summary of the quantification result in the camera, do the following:

1. On the Mode selection menu, select *Gallery*.
2. Go to the active folder.
3. Select the quantification thermal image you want to view.
4. Push the joystick or tap the screen. This displays the top toolbar.
5. On the top toolbar, select . This displays the right toolbar.
6. On the right toolbar, select . This displays the summary.

9.3.9 Save quantification files as a pdf report

To save the summary of the quantification as a pdf, do the following:

1. On the Mode selection menu, select *Gallery*.
2. Go to the active folder.
3. Select the quantification thermal image you want to view.
4. Push the joystick or tap the screen. This displays the top toolbar.
5. On the top toolbar, select . This displays the right toolbar.
6. On the right toolbar, select .
7. A pdf report is created.

9.3.10 Transfer quantification files

The quantification files are stored on the memory card.

You can upload the quantification files to your FLIR Ignite account or transfer the files manually using the USB cable or the memory card.

9.4 Practical information

9.4.1 Measurement position

Once a leak is identified, the operator will observe the leak from several positions to find a viewing angle that gives the camera the best measurement position to quantify the leak.

Factors to consider when determining the optimal viewing angle:

- Ideally, you will want an unobstructed view of the leak location. If this is not possible, you will want an unobstructed view of the gas plume.
- Selecting a suitable background is important as quantification requires sufficient thermal contrast. In general, the gas plume will be the same temperature as the ambient air temperature because the small amount of gas escaping from the equipment and entering the atmosphere will quickly equilibrate with ambient temperature. The background should be at least 2°C (3.6°F) warmer (or colder) than ambient temperature to provide sufficient contrast to quantify the plume. This is critical for an accurate measurement.
- Select a location suitable for the camera. You will need to mount the camera on a tripod so look for a relatively flat surface within a reasonable distance of the leak. It is best to place the camera at a distance somewhere between 5 to 15 feet for small leaks and from 20 to 40 feet for large leaks. See also section 9.4.1.1 *Distance and range*.

9.4.1.1 Distance and range

Distance from the camera to the gas leak is another parameter you will need to enter into the quantification module. While the quantification feature is agnostic to range (i.e., the quantification feature will operate at any distance within the method limits), you must provide this distance for accurate quantification.

The range for the quantification feature is a function of the lens attached to the camera. For the 23 mm lens (24° FOV) the range is from 5 feet to 54 feet (1.5 to 16 meters). For the 38 mm lens (14° FOV) the range is from 8 feet to 90 feet (2 to 27 meters) For the 92 mm lens (6° FOV) the range is from 20 feet to 210 feet (6 to 64 meters). In general, small leaks should be measured near the bottom of the range and large leaks should be measured near the top of the range.

9.4.2 Measure Ambient Temperature

The ambient air temperature is one of the parameters you will need to provide to the quantification module. The measurement of this air temperature should be taken within

the same general area as the gas leak, although it is not necessary to get into the midst of the gas leak. A measurement taken at the location of the camera is generally acceptable unless there is a significant temperature gradient between the leak location and the location of the camera. A measurement read off an instrument like a smart phone that gives the general temperature of the city is NOT recommended as local temperature can vary considerably (especially in close proximity to process equipment).

A few words of caution when obtaining the air temperature:

- Do not place the thermometer in direct sunlight as the solar heating tends to bias the reading high.
- Do not place the thermometer on the ground as this may not be representative of true ambient air temperature.
- Ideally the thermometer should be placed in a position where it is exposed to the same free-flow ambient air conditions as the gas plume and free from potential interferences such as direct sunlight or other radiating heat sources.

It is strongly recommended that the ambient temperature be measured each and every time a quantification is performed.

9.4.3 Assessing delta temperature

Use the Delta T feature to show areas of the field of view where there is insufficient delta temperature for quantification. Those areas will be highlighted red.

If parts of the scene are below the minimum delta temperature, it may still be possible to perform a measurement. If you can position the camera so that the measurement ring is placed in a region of good delta temperature, then you can proceed with the measurement. If that is not possible, try changing the viewing angle. Recall that for quantitative optical gas imaging, both reflected energy and emitted energy contribute to the apparent temperature. It is often possible to change the apparent temperature just by changing the viewing angle to the background, thereby changing the amount of energy reflected to the camera. If you can find no angle or camera position that provides sufficient delta temperature, then you may not be able to perform a measurement. Returning to the site at a different time of day will often yield a different delta temperature.

9.4.4 Camera temperature range

For each background, you should check to see that the camera is operating in the proper temperature range. The camera will provide the upper and lower temperatures for each range and a visual indicator to show the distribution of the pixels in the image. If a majority of the pixels are near the top or the bottom of the temperature range, the operator should adjust the temperature range to obtain accurate quantification results. A common scenario where this becomes necessary occurs when the sky is used as a background. The sky typically has very little radiance in the mid-wave infrared. As a result, the apparent temperature of the sky can be quite low. It is often necessary to lower the temperature range of the camera when switching to a sky background.

9.4.5 Field of view and focus

A critical component of the leak rate measurement process is adjusting the field of view (FOV) for the camera. The camera should be positioned so that the leak location is in the center of the FOV. You should verify that the gas leak is in the center of the measurement boundary (i.e. the ring) and that the gas plume is flowing across the measurement boundary. In general, the best quantification results will be obtained if the leak originates in the center of the FOV with a clear field of view as the plume passes across the measurement boundary roughly perpendicular to the camera FOV.

In some cases, it is easy and obvious to determine the location of the leak. These leaks are emanating from a single location and the plume emanates from that single location. In other cases, the leak is emanating from a component such as a flange or valve without a clearly defined source. In these cases, centering the component in the FOV is sufficient.

The focus of the camera can potentially affect the measurement. The user should take care to ensure that both the leak site (leaking component or plume) as well as the background are in focus. This may or may not be feasible depending on the camera lens used (which determines the depth of field), the distance between the leak site and the background objects, and the distance to the camera. When it is not feasible to bring both the plume and the background into focus, priority should be given to the plume.

9.4.6 Leak rate versus concentration

The camera allows you to measure both flow rate and concentration.

9.4.6.1 Flow rate

When measuring flow rate (i.e. volumetric or mass emission rate), a ring is displayed on the image. The ring represents a flux boundary. The measurement result represents the amount of plume crossing this boundary.

The ring is always centered and the ring size generally cannot be changed. You will notice that the ring size does change as you change the distance or lens.

9.4.6.2 Concentration

When measuring concentration, a box is displayed on the image. You are now measuring a path averaged concentration rather than an emission rate.

The camera will report the maximum ppm-m concentration within the box. You can resize and move the box.

9.5 Method limits

The quantitative method in the camera has certain limits. For example, the method requires a minimum delta temperature of 2°C for accurate results. The method limits for distance are a function of the lens:

- 23 mm lens (24° FOV): 5 feet to 54 feet (1.5 to 16 meters)
- 38 mm lens (14.5° FOV): 8 feet to 90 feet (2 to 27 meters)
- 92 mm lens (6° FOV): 20 feet to 210 feet (6 to 64 meters)

In terms of release geometry, the current method works for point releases (2" diameter or less) and diffuse releases up to 12" in diameter. With respect to leak rate, the current method has been calibration from 0.2 sl/m up to 300 sl/m (methane). With respect to wind speed the calibration extends to 10 mph.

Note The temperature measurement functionality is available for radiometric cameras.

10.1 Basic steps to temperature measurements

- Adjust the camera focus. This is very important for a correct temperature measurement.
- Select a temperature range that matches the expected temperature of the object you are inspecting.
- Adjusting the temperature scale can make it possible to detect anomalies and smaller temperature differences in the part of the image of interest.
- For accurate temperature measurements, it is important to set the measurement parameters.

10.2 Measurement tools

To measure a temperature, you can use one or more measurement tools, e.g., a spot or a box.



1. Alarm
2. Result table
3. Box
4. Spot
5. Temperature scale

10.2.1 Add and remove a tool

On the main toolbar, select *Measurement*. This displays a toolbar, where you can do the following:

- Remove all tools.
- Add a center spot.
- Add a hot spot detection within a box area.
- Add a cold spot detection within a box area.
- Add a user preset.

10.2.2 Edit a user preset

A user preset is a measurement tool, or a group of measurement tools, with predefined characteristics.

To edit a user preset, do the following:

1. On the main toolbar, select *Measurement*.
2. Select *User preset*. Push and hold, by using the joystick or tapping the screen. This displays a toolbar.
3. Select *Add measurement*. This displays a toolbar, where you can do the following:
 - Add a spot.
 - Add a box.
 - Add a circle.
 - Add a line.
 - Set up a differential calculation (delta).

Note Before you can set up a difference calculation, you must first add at least one measurement tool.
4. The added tool is displayed with one or more handles.
5. Push the joystick or tap the menu button. This displays a toolbar, where you can do the following (depending on the type of tool):
 - Remove the tool.
 - Resize, move, center, and rotate the tool. See also section 10.2.3 *Move and resize a tool*.
 - Set alarms. See also section 10.2.7 *Set up a measurement alarm*.
 - Set the camera to display maximum, minimum, and average values. See also section 10.2.4 *Display values in the result table*.
 - Set local parameters.
 - When completed, select *Done*.
6. When all measurement tools have been added, select *Save as user preset*.

10.2.3 Move and resize a tool

Note Any changes of position and size of the current tool will be lost if you select another measurement tool. If you wish to keep the position and size settings, use the user preset feature. See section 10.2.2 *Edit a user preset*.

10.2.3.1 Move a spot

1. Activate edit mode by tapping the spot on the screen. The spot is now displayed with a handle.
2. Push the joystick or tap the menu button. This displays a toolbar.
3. On the toolbar, do one or more of the following:
 - 3.1. Select *Move* and push the joystick. Move the joystick up/down and left/right to move the tool.
You can also tap and drag the spot.
 - 3.2. Select *Center* to center the spot on the screen.
 - 3.3. To exit edit mode, do one of the following:
 - Push the joystick and select *Done*.
 - Tap the screen outside the tool.

10.2.3.2 Move and resize a box, circle, or line tool

1. Activate edit mode by tapping the tool on the screen. The tool is now displayed with one or more handles.

Note For the box tool, tap one of the corners.
2. Push the joystick or tap the menu button. This displays a toolbar.

-
3. Select *Move/resize*. This displays a toolbar, where you can do one or more of the following:
 - Select *Resize* and push the joystick. Move the joystick up/down and left/right to resize the tool.
You can also tap and hold one of the outer handles and drag the handle to resize the tool.
 - Select *Move* and push the joystick. Move the joystick up/down and left/right to move the tool.
You can also tap the middle handle and drag to move the tool.
 - Select *Center* to center the box or circle tool on the screen.
 - Select *Rotate & center line* to rotate and center the line tool.
 4. To exit edit mode, do one of the following:
 - Push the joystick and select *Done*.
 - Tap the screen outside the tool.

10.2.4 Display values in the result table

For the box, circle, and line tools, you can set the camera to display the maximum, minimum, and average values in the result table.

To display values in the result table, do the following:

1. Activate edit mode by tapping the tool on the screen. The tool is now displayed with one or more handles.

Note For the box tool, tap one of the corners.
2. Push the joystick or tap the menu button. This displays a toolbar.
3. Select *Max/Min/Avg*. This displays a toolbar, where you can do one or more of the following:
 - Display the maximum value.
 - Display the minimum value.
 - Display the average value.
 - Display the maximum and minimum markers (hot/cold spots).
4. Push the joystick or tap the button to toggle the function between inactive and active.
5. When completed, do one of the following:
 - Push the Back button. On the toolbar, select *Done*.
 - Tap the screen outside the tool.

10.2.5 Display a graph

For the line tool, you can set the camera to display a graph.

To display a graph, do the following:

1. Select the line tool by tapping the tool on the screen. The tool is now displayed with one or more handles.
2. Push the joystick or tap the menu button. This displays a toolbar.
3. Select *Graph/Max/Min/Avg* and then select *Graph*.
4. Push the joystick or tap the button to toggle the function between inactive and active.
5. When completed, do one of the following:
 - Push the Back button. On the toolbar, select *Done*.
 - Tap the screen outside the tool.

10.2.6 Set up a difference calculation

A difference calculation gives the difference (delta) between two measurement results. You can also set up a difference calculation for a measurement result and a fixed temperature.

You can set up a difference calculation when previewing an image, when defining user presets, or when editing an image in the archive.

Note Before you can set up a difference calculation, you must first add at least one measurement tool.

To set up a difference calculation, do the following:

1. If you are defining user presets, select *Add measurement*. This displays a toolbar.
2. If you are in edit mode in the *Gallery*, do the following:
 - 2.1. Push the joystick or tap the screen. This displays a toolbar.
 - 2.2. Select *Measurement*. This displays a toolbar.
3. On the toolbar, select *Add delta*. This displays a dialog box where you can select the measurement tools that you want to use in the difference calculation. You can also select a fixed-temperature reference.
4. To close the dialog box, push the Back button.

10.2.7 Set up a measurement alarm

You can make the camera trigger an alarm when certain measurement conditions are met.

The camera supports the following types of alarm:

- *Above*: Triggers an alarm when the temperature is above the preset alarm temperature.
- *Below*: Triggers an alarm when the temperature is below the preset alarm temperature.

10.2.7.1 Set up an alarm for a spot, box, circle, or line tool

Note Before you can set up an alarm for a box, circle, or line tool, you must first set the camera to display at least one value (maximum, minimum, or average) in the result table. For more information, see section 10.2.4 *Display values in the result table*.

To set an alarm, do the following:

1. Select the tool by tapping the tool on the screen. The tool is now displayed with one or more handles.
2. Push the joystick or tap the menu button. This displays a toolbar.
3. On the toolbar, select *Set alarm*. This displays a dialog box.
4. In the dialog box, you can define the settings for the alarm.
 - *Alarm condition*: The condition that triggers the alarm (*Above* or *Below*). Select *Off* to deactivate the alarm.
 - *Select measurement*: Available options are the values you have previously defined for the tool (*Max*, *Min*, and/or *Avg*).
 - *Alarm limit*: The temperature value that will be the critical condition when an alarm is triggered or not.
5. To close the dialog box, push the Back button.
6. To exit edit mode, do one of the following:
 - Push the joystick and select *Done*.
 - Tap the screen outside the tool.

10.2.7.2 Set up an alarm for a difference calculation

You can set up an alarm for a difference calculation when defining user presets, or when editing an image in the archive.

To set up an alarm for a difference calculation, do the following:

1. If you are in edit mode in the *Gallery*, do the following:
 - 1.1. Push the joystick or tap the screen. This displays a toolbar.
 - 1.2. Select *Measurement*. This displays a toolbar.

-
2. On the toolbar, select *Select > Delta*. This displays a toolbar.
 3. Select *Set alarm on delta*. This displays a dialog box.
 4. In the dialog box, you can define the settings for the alarm.
 - *Alarm condition*: The condition that triggers the alarm (*Above* or *Below*). Select *Off* to deactivate the alarm.
 - *Alarm limit*: The temperature value that will be the critical condition when an alarm is triggered or not.
 5. To close the dialog box, push the Back button.

10.3 Temperature range

The camera is calibrated for different temperature ranges. The available temperature range options depend on the camera model.

For accurate temperature measurements, you must select a temperature range that matches the expected temperature of the object you are inspecting.

To change the temperature range, do one of the following:

- Push the Temperature range button and then select a temperature range by using the joystick or touching the screen. See also section 6.9 *Temperature range*.
- On the *Settings* menu, select *Camera temperature range*. This displays a menu where you can select the temperature range.

10.4 Adjust the temperature scale

Adjusting the temperature scale can make it possible to detect anomalies and smaller temperature differences in the part of the image of interest.

For instructions on how to manually adjust the temperature scale, see section 7.3 *Thermal image adjustment*.

10.5 Measurement parameters

For very accurate measurements, it is important to set the measurement parameters.

Note During normal operation there is typically no need to change the default measurement parameters, see section 10.5.2 *Recommended values*.

10.5.1 Types of parameters

The camera can use these measurement parameters:

- *External IR window compensation*, i.e., the temperature of any protective windows, protective shields, etc., that are set up between the camera and the object of interest. If no protective window is used, this value is irrelevant and should be left inactive.
- *Object distance*, i.e., the distance between the camera and the object of interest.
- *Atmospheric temperature*, i.e., the temperature of the air between the camera and the object of interest.
- *Relative humidity*, i.e., the relative humidity of the air between the camera and the object of interest.
- *Reflected temperature*, which is used when compensating for the radiation from the surroundings reflected by the object into the camera. This property of the object is called "reflectivity."
- *Emissivity*, i.e., how much radiation an object emits, compared with the radiation of a theoretical reference object at the same temperature (called a "blackbody"). The opposite of emissivity is reflectivity. The emissivity determines how much of the radiation originates from the object as opposed to being reflected by it.

Note There is an *Emissivity mode* setting, which you can use to enter the emissivity by material instead of by value. Select *Settings > Device settings > User interface options > Emissivity mode > Select from materials table*.

Emissivity is the most important measurement parameter to set correctly. If the *Emissivity* is set to a low value, the *Reflected temperature* also becomes important. The parameters *Object distance*, *Atmospheric temperature*, and *Relative humidity* are relevant for longer distances. The *External IR window compensation* must be activated if a protective window is used.

10.5.2 Recommended values

If you are unsure about the values, the following are recommended:

Object distance	1.0 m (3.3 ft.)
Atmospheric temperature	20°C (69°F)
Relative humidity	50%
Reflected temperature	20°C (69°F)
Emissivity	0.95

10.5.3 Set the measurement parameters

You can set the measurement parameters globally. You can also change the *Emissivity*, *Reflected temperature*, and *Object distance* parameters locally for a measurement tool.

Local parameters are normally only effective for a fixed setup, where each measurement tool is set for a specific object of interest. For a general handheld application, the global parameters are usually sufficient.

Note

- *Emissivity* and *Reflected temperature* are the two most important measurement parameters to set correctly in the camera.
- If you change the *Emissivity*, monitor the temperature range and make sure it remains appropriate.

10.5.3.1 Set global parameters

1. Push the joystick or tap the menu button. This displays the main toolbar.
2. Select *Measurement parameters*. This displays a toolbar.
3. On the toolbar, select a parameter. This displays a dialog box, where you can change the parameter value.
4. To close the dialog box, push the Back button.

10.5.3.2 Change local parameters

You can change the local parameters for a measurement tool.

A *P* next to the measurement tool on the screen indicates that local parameters have been activated for the tool.

1. Select the tool by tapping the tool on the screen. The tool is now displayed with one or more handles.
2. Push the joystick or tap the menu button. This displays a toolbar.
3. Select *Use local parameters*.
4. Push the joystick or tap the button to activate the use of local parameters. This displays a toolbar.
5. On the toolbar, select a parameter. This displays a dialog box, where you can change the parameter value.
6. To close the dialog box, push the Back button.
7. To exit edit mode, do one of the following:
 - Push the joystick and select *Done*.
 - Tap the screen outside the tool.

Note When you select another measurement tool, the local parameters are reset. If you wish to keep the local parameter settings, use the user preset feature. See section 10.2.2 *Edit a user preset*.

10.6 Color alarms and isotherms

By using color alarms (isotherms), anomalies can easily be discovered in an infrared image. The isotherm command applies a contrasting color to all pixels with a temperature above, below, or between the set temperature levels.

The camera also features isotherm types that are specific to the building trade:

- **Condensation alarm:** Detects areas with potential moisture problems. The alarm will trigger when the relative humidity is above a preset value.
- **Insulation alarm:** Detects areas where there may be an insulation deficiency in the building. The alarm will trigger when the insulation level is below a preset value of the energy leakage through a wall.

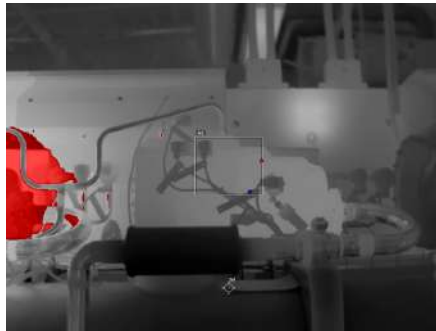

Above alarm: Highlights all pixels with a temperature above the specified temperature level.

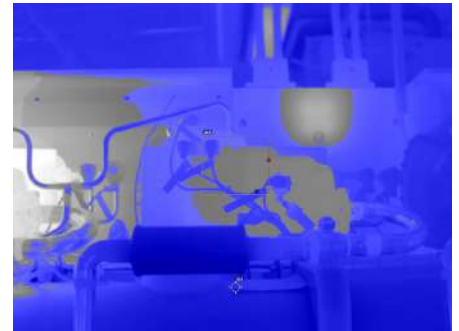

Below alarm: Highlights all pixels with a temperature below the specified temperature level.



Interval alarm: Highlights all pixels with a temperature between two specified temperature levels.

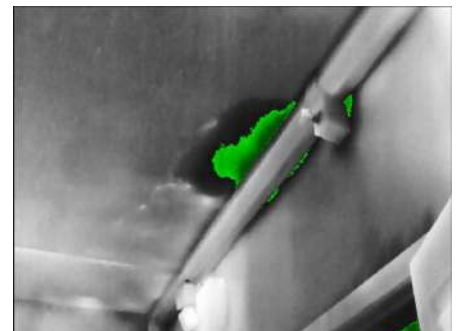

Condensation alarm: Highlights areas with potential moisture problems.

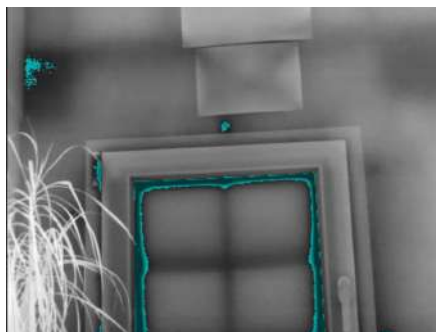

Insulation alarm: Highlights areas where there may be an insulation deficiency in a building.

10.6.1 Set up a color alarm

To set up a color alarm, do the following:

1. Push the joystick or tap the menu button. This displays the main toolbar.
2. Select *Color*. This displays a toolbar.
3. On the toolbar, select a color alarm. This displays a dialog box where you can define the settings for the alarm.

Settings for the *Above alarm* and *Below alarm*:

- *Temperature limit*
- *Palette*

Settings for the *Interval alarm*:

- *Low temperature*
- *High temperature*
- *Palette*

Settings for the *Condensation alarm*:

- *Atmospheric temperature*: The current atmospheric temperature.
- *Relative humidity*: The current relative humidity.
- *Relative humidity limit*: The relative humidity level at which you want the alarm to be triggered. A relative humidity of 100% means that water vapor condenses from the air as liquid water (= dewpoint). A relative humidity of about 70% or above can cause mold.

Settings for the *Insulation alarm*:

- *Indoor temperature*: The current indoor temperature.
- *Outdoor temperature*: The current outdoor temperature.
- *Thermal index*: The insulation level (an integer between 0 and 100).

4. To close the dialog box, push the Back button.

11.1 Save an image

To save an image, do the following:

1. On the Mode selection menu, select *Camera*.
2. To save an image, push the Record button.

Note Depending on the settings in *Settings > Save options & storage*, the following may happen:

- A preview image is displayed before the image is saved.
- An annotation tool or the Annotation menu is displayed when the image has been saved.

11.1.1 Preview an image

You can preview an image before you save it. This allows you to see if the image contains the information you want before you save it. You can also adjust and edit the image.

Note Preview is enabled by a setting. On the *Settings* menu, select *Save options & storage > Preview image before saving*.

1. On the Mode selection menu, select *Camera*.
2. To preview an image, push the Record button.
3. Manual adjustment mode is now active. For image adjustment instructions, see section 7.3 *Thermal image adjustment*.
4. To edit the image, push the joystick or tap the screen. This displays a toolbar, where you can add a measurement tool and change the global parameters, image mode, and color palette.
5. Do one of the following:
 - To save the image, push the Record button.
 - To exit without saving, push the Back button.

11.2 Annotate an image

You can save additional information with an image by using annotations. Annotations make reporting and post-processing more efficient by providing essential information about the image, e.g., conditions and information about where an image is taken.



Annotations are added to the image file and can be viewed and edited in the camera or in a FLIR Thermography software.

- You can set the camera to display annotation tools when an image is saved. On the *Settings* menu, select *Save options & storage > Add annotation after saving*.
- You can also add annotations to a saved image in the image archive.



To add an annotation to a saved image, do the following:

1. Open the image in the *Gallery*.
2. Push the joystick or tap the screen. This displays the top toolbar.
3. On the top toolbar, select . This displays the right toolbar.

4. On the right toolbar, do one of the following:

- Select  to add a text note. This displays a soft keyboard, where you can enter text by touching the screen.
- Select  to add a text table. This displays a table.

4.1. (Optional step.) On the top toolbar, do one of the following:

- Select  to clear the content of the current table.
- Select  to select another table template.

4.2. For each row in the table, do the following:

- Push the joystick. This displays the predefined values.
- Push the joystick up/down to select a predefined value. Push the joystick to confirm.
- Instead of selecting a predefined value, you can select the keyboard icon and enter other text by touching the screen.

Note Text entered by the keyboard will be saved to the text comment table template. Next time you add a text comment table annotation, the entered text will be displayed as a predefined value.

- Select  to add a voice annotation. This displays a toolbar.

On the toolbar, do the following:

- Select *Record* to start the recording.
- Select *Stop* to stop the recording.
- Select *Play* to listen to the recording.
- Select *Delete* to delete the recording.

Note To record a voice annotation, you need a Bluetooth headset. See section 11.2.2 *Voice annotation*.

- Select  to add a sketch.

4.1. You are now in sketch mode. Draw the sketch by touching the screen.

4.2. (Optional step.) Push the joystick. This displays a toolbar, where you can do the following:

- Select *Draw* to change the color of the sketch tools.
- Select *Eraser* to erase parts of the sketch by touching the screen.
- Select *Stamp sketch* to add an arrow, circle, or cross. The selected stamp is displayed in the center of the screen. You can move the stamp by using the joystick or by touching the screen.
- Select *Clear all* to clear all sketches.

11.2.1 Text comment table

You can save a table with textual information to the image file. This feature is a very efficient way of recording information when you are inspecting a large number of similar objects. The idea behind using a table with textual information is to avoid filling out forms or inspection protocols manually.

The camera ships with an example text comment table template. You can also create your own templates.

11.2.1.1 Creating a text comment table template

You can create a text comment file manually. You can also create a text comment file using a FLIR Thermography software.

11.2.1.1.1 Manually creating a table template

A text comment file (*.tcf) is an annotation format that is proprietary to FLIR Systems. It defines a table structure that can be used to add text table annotations to FLIR images. You can create text comment files (*.tcf files) and use these files as table templates in the camera.

The camera ships with an example text comment table file: `example_text_comment.tcf`. The file is stored on the memory card in the subfolder `\TextTableTemplates`. You can make a copy of the example file and modify it using a text editor such as Microsoft Notepad.

When creating or modifying a text comment file, keep the following rules in mind:

1. Lines starting with “#” are regarded as comments and will be ignored.
2. Lines that start with “<” and end with “>” are labels and will appear on the left-hand side of the table.
3. Non-empty lines under a label line are regarded as values and will be displayed as options to the label above.
4. When you save the file, select UTF-8 encoding. With UTF-8 encoding, the file will support all languages currently supported by the camera.
5. The template will be updated by the camera if you add or remove values in the text table annotations dialog in the camera. This enables you to modify its content while you are working with the camera.
6. The camera will find all text table template files if:
 - They are placed on the memory card in the subfolder `\TextTableTemplates`.
 - They have an ASCII filename and the file extension `.tcf`. (ASCII characters include a–z, A–Z, 0–9, and basic punctuation, and spaces can be used. The file can contain non-ASCII text, but the filename must be ASCII.)

11.2.1.1.1.1 Example mark-up structure

The file format for the text comment table template is *.tcf. This code sample is an example mark-up structure of such a file, and shows how the mark-up appears in a text editor such as Notepad.

```
<Site>
Company A
Company B
<Location>
Substation A
<Object>
Engine
Vent
Vault
Door
<ObjectID>
Ala1
Alb2
Alc3
<Deviation>
Overload
Moisture
Draft
<Remedy>
Replace
Fix
No action
<Severity>
Critical
Non-critical
<Severity>
```

11.2.2 Voice annotation

A voice annotation is an audio recording that is saved to the infrared image file. The recording can be played back in the camera, and in image analysis and reporting software from FLIR Systems.

The voice annotation is recorded using a Bluetooth headset. For information on how to pair a headset with the camera, see section 14.2 *Bluetooth*.

11.3 About image files

When you save an image, the camera stores the image file on the memory card.

Note Empty or use a memory card that has not previously been used in another type of camera. The cameras may organize files differently on the memory card. There is therefore a risk of losing data if the same memory card is used in different types of cameras.

11.3.1 File-naming convention

The default naming convention for image files is FLIRxxxx, where xxxx is an incremental counter.

It is also possible to save images with a date prefix added to the filename. However, these files may not automatically be detected by third-party applications. For more information, see section 16.6 *Save options & storage*.

11.3.1.1 Resetting the image counter

Note To prevent image files being overwritten, the new counter value will be based on the highest existing filename number in the image archive. To ensure that the counter is reset to 0001, insert an empty memory card before resetting the counter.

To reset the numbering of the image filenames, select *Settings > Device settings > Reset options > Reset image counter...* This displays a dialog box where you can select to reset the counter.

11.3.2 Image files

The camera saves an image file that includes all thermal and visual information. This means that you can open an image file at a later time and, for example, change the color palette, apply another image mode, and add measurement tools.

The image *.jpg file is fully radiometric and saved lossless, which enables full post-processing in image analysis and reporting software from FLIR Systems. There is also a regular *.jpg component (lossy) for convenient viewing in non-FLIR Systems software.

Note

- An image saved in *HSM* mode does not include all thermal information, meaning that you can only change the color palette in post-processing.
- The camera can also be configured to save an extra low-resolution visual image as a separate file. This can be convenient if you are not using a post-processing software. Select *Settings > Save options & storage > Photo as separate JPEG*.
- When the *Digital camera* image mode is selected, a high-resolution digital image is stored when an image is saved. However, no thermal information is stored.

12.1 Record a video

To record a video, do the following:

1. On the Mode selection menu, select *Video*.
2. To start the recording, push the Record button.
3. To stop the recording, push the Record button again. The recording is automatically saved.

Note

- The camera can be configured to save video in *.mpg or *.csq format. Select *Settings > Save options & storage > Video compression*.
 - *Mpeg (*.mpg)*: Mpeg recordings cannot be edited after the file has been saved.
 - *Radiometric storage (*.csq)*: An *.csq file supports full radiometry but is only supported by FLIR Systems software. The file does not include any visual image information. With this setting, it is not possible to record video in *HSM* mode. Also, only the image mode *Thermal* is supported. If any non-supported mode is active when *Video* recording mode is selected, the camera will auto-switch to *Thermal* image mode.

12.2 Periodic saving (time-lapse)

You can program the camera to save images periodically (time-lapse).

1. On the Mode selection menu, select *Time-lapse*.
 2. On the main toolbar, select *Time-lapse*. This displays a dialog box.
 3. In the dialog box, you can set the save conditions:
 - *Save interval*: The time interval between each saved image.
 - *Total number of images*: The periodic saving will stop when the set number of images have been saved.
- Note** If you select “∞,” the camera will keep on saving images until the memory card is full or until you manually stop the periodic saving.
4. To close the dialog box, push the Back button.
 5. To start the periodic saving, push the Record button. The camera displays the progress on the screen.
 6. To manually stop the periodic saving, push the Record button again.

12.3 Multi-Rec

With the Multi-Rec feature, you can set up your preferred recording sequence in different image modes (IR, HSM, Digital camera) to use for documentation of a gas leak. While the recording is in progress, the camera follows the sequence setup and automatically changes the image modes. The recordings of the sequences are automatically saved to a single video file in the image archive.

Note Multi-Rec video recordings are always saved in MPEG (*.mp4) format.

12.3.1 Set up recording

1. On the Mode selection menu, select *Multi-Rec*.
2. Do one of the following:
 - First time setup: Select *Set up*.
 - On the main toolbar, select *Settings*.
3. For each sequence, do the following:
 - 3.1. Select the image mode.

3.2. Select the time period.

12.3.2 Start recording

1. On the Mode selection menu, select *Multi-Rec.*
2. On the main toolbar, select *Start recording.*
3. The camera displays the progress of the recording on the screen.
4. When completed, the recording is automatically saved.

When you save a video or image, the camera stores the file in the image archive on the memory card. You can open and play saved video clips. You can also open an image and, for example, change the color palette, apply another image mode, and add measurement tools.

Multi-Rec recordings and Quantification results are also stored in the image archive on the memory card.

In the camera, the image archive is called *Gallery*. The *Gallery* can include one or several folders. New videos and images will be saved to the active folder, at the top level of the *Gallery*. You can create new folders, rename a folder, change the active folder, move files between the folders, and delete folders.

13.1 Open the Gallery

On the Mode selection menu, select *Gallery* to open the *Gallery*.

13.2 Open video and image files

1. Go to a folder in the *Gallery*.
2. Select the video or image you want to view.
3. To view the previous/next file, move the joystick left/right or swipe left/right on the screen.
4. To display the top toolbar, push the joystick or tap the screen.

Video files:







- To play the video, select  on the top toolbar. To play or pause the video, push the joystick or tap the screen.
- To display information or delete the video, select . This displays the right toolbar.

Image files:

- To switch between the thermal image and visual image, select  on the top toolbar.
- To edit the image, add annotations, display information, or delete the image, select . This displays the right toolbar.

13.3 Edit an image



1. Open the image in the *Gallery*.
2. Push the joystick or tap the screen to display the top toolbar.
3. On the top toolbar, select .
4. On the right toolbar, select . This opens the image in edit mode.
5. Manual adjustment mode is now active. For image adjustment instructions, see section 7.3 *Thermal image adjustment*.

6. Push the joystick or tap the screen. This displays a toolbar, where you can do the following:

- Exit edit mode.
- Change the global measurement parameters.
- Change the image mode.
- Add a measurement tool.
- Change the color palette or set a color alarm.
- Save and exit edit mode.

Note For an image saved in *HSM* mode, only the color palette can be changed.



13.4 Save file as a pdf report

1. On the Mode selection menu, select *Gallery*.
2. Go to the active folder.
3. Select the quantification thermal image you want to view.
4. Push the joystick or tap the screen. This displays the top toolbar.
5. On the top toolbar, select . This displays the right toolbar.
6. On the right toolbar, select .
7. A pdf report is created.

13.5 Add a folder



1. Go to the top level in the *Gallery*.
2. On the top toolbar, select .
3. Enter a folder name. Then select *Done*.
4. The new folder automatically becomes the active folder and appears at the top of the *Gallery*.

13.6 Rename a folder

1. Go to the top level in the *Gallery*.
2. On the top toolbar, select .
3. Select the folder to rename.
4. On the right toolbar, select .
5. Enter the new name. Then select *Done*.



13.7 Change the active folder

New videos and images are saved to the active folder.

1. Go to the top level in the *Gallery*.
2. On the top toolbar, select .
3. Select the folder that new videos and images should be saved to.
4. On the right toolbar, select .

5. The selected folder is moved to the top of the *Gallery*.

13.8 Move files between folders

1. Go to a folder in the *Gallery*.
2. On the top toolbar, select .
3. Select the files you want to move.
4. On the right toolbar, select .
5. Select the destination folder.



13.9 Upload files and folders

You can manually upload images, videos and folders to your FLIR Ignite account when the camera is connected to the internet. For more information, see section 14.3.6 *Manual upload*.



You can also upload the files via the camera web interface, see section 14.4 *Camera web interface*.

13.10 Delete files and folders



13.10.1 Delete folders

1. Go to the top level in the *Gallery*.
2. On the top toolbar, select .
3. Select the folders you want to delete.
Note The active folder cannot be deleted.
4. On the right toolbar, select . This displays a dialog where you can select to delete the selected folders.

13.10.2 Delete a file

1. Open the file in the *Gallery*.
2. Push the joystick or tap the screen to display the top toolbar.
3. On the top toolbar, select .
4. On the right toolbar, select . This displays a dialog where you can select to delete the file.

13.10.3 Delete multiple files

1. Go to a folder in the *Gallery*.
2. On the top toolbar, select .
3. Select the files you want to delete.
4. On the right toolbar, select . This displays a dialog where you can select to delete the selected files.

13.10.4 Delete all files

To delete all files from the memory card, select *Settings > Save options & storage > Delete all saved files...* This displays a dialog box where you can select to permanently delete all saved files on the memory card.

14.1 Wi-Fi

You can connect the camera to a Wi-Fi network or let the camera provide Wi-Fi access to other devices, such as a mobile phone or tablet.

The Wi-Fi functionality is managed on the *Settings* menu. You can also enable/disable Wi-Fi on the Quick menu.

14.1.1 Connect the camera to Wi-Fi

You can connect the camera to a Wi-Fi network as part of the initial setup of the camera. You can also connect the camera at any time via the *Settings* menu.

To connect to Wi-Fi via the *Settings* menu, do the following:

1. On the *Settings* menu, select *Connections* > *Wi-Fi*.
2. Select *Wi-Fi = On*.
3. Select one of the available networks.

Note

- Password-protected networks are indicated with a padlock icon, and for these you will need to enter a password the first time you connect to the network. After that the camera will connect automatically to the network. To disable the automatic connection, select the network in the list and then select *Forget network*.
- Some networks do not broadcast their existence. They appear in the list as *Untitled*. To connect to such a network, you will be prompted to enter additional parameters.
- To enable/disable the camera firewall, select *Settings* > *Connections* > *Advanced* > *Global firewall*. It is recommended to keep the camera firewall enabled. Only disable the firewall when experiencing problems connecting to legacy applications.

14.1.2 Set up the camera as a wireless access point

1. On the *Settings* menu, select *Connections* > *Wi-Fi* > *Share*.
2. To display and change the parameters, select *Share settings*.
 - To change the name of the network, select *Network name (SSID)*.
 - To change the password, select *Password*.

Note The network name and password will be used by the external device to connect to the camera network.

- Use the *Shared network firewall* switch to enable/disable the firewall for the camera network.

Note To enable/disable the camera firewall, select *Connections* > *Advanced* > *Global firewall*.

14.2 Bluetooth

You can use the camera with a Bluetooth-enabled headset, to record voice annotations. If supported by your mobile phone, you can also share the phone's internet connection with the camera via Bluetooth.

The Bluetooth functionality is managed on the *Settings* menu. You can also enable/disable Bluetooth on the Quick menu.

14.2.1 Pair Bluetooth devices

1. On the *Settings* menu, select *Connections* > *Bluetooth*.

2. Select *Bluetooth = On*.

Note You also need to ensure that the external Bluetooth device is in visible mode. On the mobile phone, you must make sure that Bluetooth is enabled, that the phone is in discovery mode, and that Bluetooth tethering is enabled.

3. Select *Available devices*.
4. Wait until a list of available Bluetooth devices is displayed.
5. Select a device to begin the pairing procedure.

14.3 Cloud connectivity

FLIR Ignite is a cloud storage service for thermal images and videos. With FLIR Ignite, you can upload image and video files, including Quantification and Multi-Rec files, from your camera to your FLIR Ignite account, allowing you to access the files from a computer or mobile device whenever you need to.

With FLIR Ignite you can edit images and create basic reports. You can also share files with colleagues and clients and invite team members to work in the same folder and files.

FLIR Ignite also includes a PC-based application called FLIR Ignite Sync that allows you to sync your image library with your computer. This gives you easy access to images when creating reports in FLIR Thermal Studio or other post-processing software.

14.3.1 Setup

You can set up the camera to upload image and video files to FLIR Ignite.

If automatic upload is enabled, new images and videos will automatically be uploaded to the FLIR Ignite account. You can also upload files manually from the *Gallery*.

To be able to upload files, you need to connect the camera to the internet and pair the camera with a FLIR Ignite account.

14.3.2 Create FLIR Ignite account

To create a FLIR Ignite account, go to <https://ignite.flir.com> and click *Sign up*.

14.3.3 Connect camera to internet

You can connect the camera to the internet via Wi-Fi or Bluetooth. For more information, see sections 14.1.1 *Connect the camera to Wi-Fi* and 14.2.1 *Pair Bluetooth devices*.

Note The Bluetooth protocol is limited in terms of data transfer and best suited for upload of single images. For upload of videos and folders with several images, it is recommended to use Wi-Fi.

14.3.4 Pair with FLIR Ignite

1. Make sure the camera is connected to the internet.
2. On the *Settings* menu, select *FLIR Ignite*.
3. Start the pairing procedure by selecting *Sign in*.
4. Use a computer or other device with internet access and go to the website displayed on the camera screen.
5. On the website, enter the code displayed on the camera screen.
6. Sign in to your FLIR Ignite account.

14.3.5 Automatic upload

You can set up the camera to automatically upload image and video files to your FLIR Ignite account.

When automatic upload is enabled, new images and videos will automatically be uploaded when the camera is connected to the internet and paired with FLIR Ignite.

To enable automatic upload, do the following:

1. Make sure the camera is paired with your FLIR Ignite account.
2. Do one of the following:
 - On the *Quick* menu, tap the *Auto upload* button.
 - On the *Settings* menu, select *FLIR Ignite > Auto upload = On*.

14.3.6 Manual upload



You can manually upload files and folders from the *Gallery* when the camera is paired with a FLIR Ignite account and connected to the internet.

You can monitor the upload progress at the top of the *Gallery*.



Note Before uploading, make sure that:

- The camera is connected to the internet.
- The camera is paired with a FLIR Ignite account.



14.3.6.1 Upload a file

1. Open the file in the *Gallery*.
2. Push the joystick or tap the screen to display the top toolbar.
3. On the top toolbar, select .
4. On the right toolbar, select .

14.3.6.2 Upload multiple files

1. Go to a folder in the *Gallery*.
2. On the top toolbar, select .
3. Select the files you want to upload.
4. On the right toolbar, select .

14.3.6.3 Upload folders

1. Go to the top level in the *Gallery*.
2. On the top toolbar, select .
3. Select the folders you want to upload.
4. On the right toolbar, select .

14.3.7 Access FLIR Ignite

You can access FLIR Ignite from a browser on your desktop, tablet, or mobile device.

To access FLIR Ignite, go to <https://ignite.flir.com>.

For more information, refer to the FLIR Ignite user manual.

14.4 Camera web interface

Via the camera web interface, you can download files from the camera to a computer over a local network.

14.4.1 Connect the camera to the local network

1. On the *Settings* menu, select *Connections > Wi-Fi > Connect to network > Available networks*.

2. Select one of the available networks.
3. When connected, select the network again. This displays information about the connection, including the IP address of the camera.

See also section 14.1.1 *Connect the camera to Wi-Fi*.

14.4.2 Open the camera web interface

1. On a computer, enter the IP address of the camera (see section 14.4.1) into the address bar of a web browser. This displays a login page.
2. Log in with the username *admin* and the default administrator password available on the camera calibration certificate. This displays the web interface of the camera.

14.4.3 Download files

1. In the camera web interface, go to the *Library* tab.
2. On the left toolbar, select *Card #1*. This displays the folders and files on the camera memory card. You can download one or multiple files to your computer.

Note When downloading multiple files, a pop-up window appears. Make sure it is not blocked by your web browser.

15.1 General

FLIR Inspection Route is a solution that streamlines thermal inspections and simplifies data collection and reporting. The solution includes FLIR software and camera support for preparation, inspection, and post-processing.

With the Inspection Route function, the camera guides the operator along a predefined route of inspection points, where images and data are collected in a structured manner. FLIR Inspection Route speeds up post-processing and reporting by ensuring that nothing is missed and that all inspection results are organized right from the start.

The inspection work flow is defined by an inspection route file, with a high degree of flexibility. It is possible to configure an automated work flow, where the camera automatically sets the status and steps to the next inspection point when an image is saved. The operator can also manually select the status, add comments, and add more images.

The inspection route work flow typically involves the following steps:

1. Prepare the inspection route file, using one of the following methods:
 - The FLIR Thermal Studio application.
 - Your own solution. The FLIR Thermal SDK can be used to build your own export/import software or to interface your existing asset management system.
 - Create a file in the camera.
 - Manually edit a file.
2. Add the inspection route file to the camera memory card.
3. Perform the inspection using the camera.
4. Move the results from the camera using the USB cable or the memory card, or upload the results to FLIR Ignite.
5. Import the results into FLIR Thermal Studio or your own image management and reporting system.
6. Create an inspection route report.

15.1.1 FLIR Inspection Route Solution user manual

The FLIR Inspection Route Solution user manual describes how to configure an inspection route file, perform an inspection, transfer the inspection results, and create an inspection report using a camera with FLIR Inspection Route enabled, the FLIR Thermal Studio application, and the FLIR Ignite cloud service.

To access the FLIR Inspection Route Solution user manual, go to <http://support.flir.com/resources/route>.

15.2 User interface



The Inspection Route overlay consists of the following parts:

- Back arrow
Tap to go to the previous inspection point.
- Current point indicator
 - Displays the name of the current inspection point.
 - Displays an image icon if there is an image saved for the inspection point.
 - Displays the status of the inspection point.
- Next arrow
Tap to go to the next inspection point.
- Document icon
This icon is displayed if there is a description and/or comment available for the inspection point. A description comes from the inspection route file and can, for example, include instructions or reminders for the inspection point. Comments are text notes added during the inspection. Tap the icon to display the description and/or comment.

15.2.1 Drop-down menu

To display the drop-down menu, tap the current point indicator.

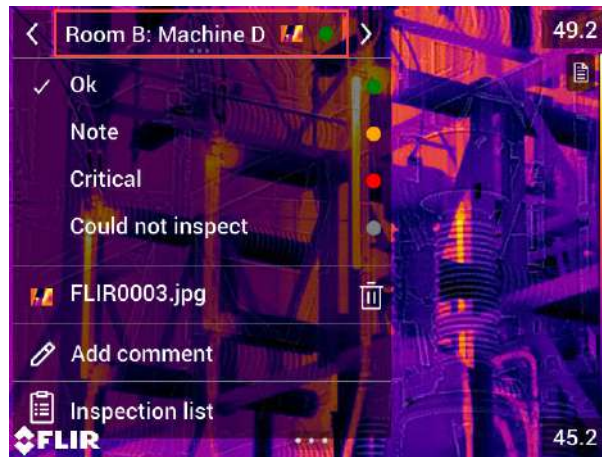

In the drop-down menu it is possible to:

- Set the status of the current inspection point.
- View the filenames of images and videos saved for this inspection point.
- Add comments for the current inspection point.
- Open the inspection list, see section 15.2.2 *Inspection list*.

15.2.2 Inspection list

The inspection list gives an overview of the routes and their progress. It also allows editing of the inspection route.

The contents of the inspection list are defined by the inspection route file. The route structure and names come from the file.

To open the inspection list, tap the current point indicator and then tap *Inspection list*.

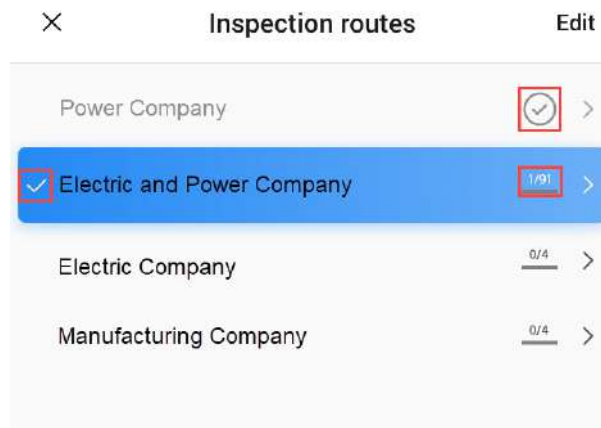

Figure 15.1

Figure 15.1 shows an example of the inspection list:

- The first inspection route is completed and locked, which is indicated by the check mark to the right.
- The second inspection route has started. It includes a total of 91 inspection points, and one of them has been inspected. The second inspection route includes the current inspection point in live view, which is indicated by the check mark to the left.

To display the next level in the inspection route structure, tap an item in the list.

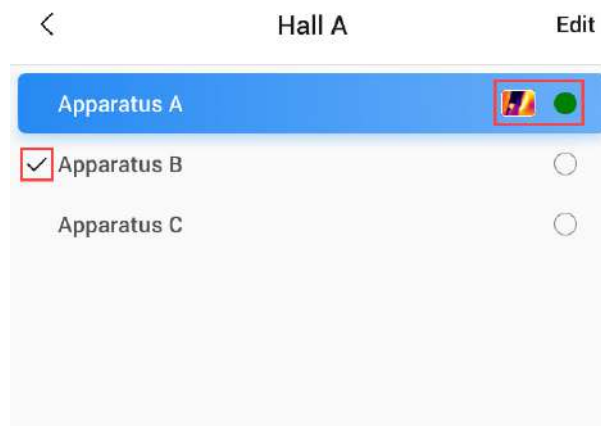

Figure 15.2

Figure 15.2 shows an example of a level with inspection points:

- The first inspection point has one or more images and the status is set to “green.”
- The second inspection point is the current inspection point in live view, which is indicated by the check mark to the left.

15.3 Performing an inspection

15.3.1 Preparation

Note This procedure assumes that an inspection route file has been created. For more information, see section 15.5 *Creating an inspection route*.

1. Add the inspection route file to the root folder on the memory card.
2. Insert the memory card into the camera.
3. Start the camera.

4. Activate the Inspection Route function by selecting  (*Settings*) > *Save options & storage* > *Inspection route*, and then toggle the *Inspection route* switch.
5. The camera is now ready.

15.3.2 Capturing inspection data

Once the camera is prepared, the inspection can start.

Note You can turn off the camera in the middle of an inspection. The camera will always save all data. When the camera is turned on again, it will display the first uncompleted inspection point.



1. The current point indicator displays which inspection point to inspect.
2. To view a description of the inspection point, e.g., instructions or reminders, tap the document icon.

Note The document icon is only displayed if there is a description and/or comment available for the inspection point.

3. When you are at the inspection point, take an image. The camera automatically saves the image and sets the default status.

Note The default status is defined by the inspection route file. It is possible to change the default status in the camera, see section 15.4 *Configuration*.

4. To edit the inspection point data, tap the current point indicator. This displays a drop-down menu where you can do the following:
 - Set the status of the inspection point, see section 15.3.3.1 *Setting the status*.
 - Delete the image, see section 15.3.3.2 *Deleting an image*.
 - Add a comment, see section 15.3.3.3 *Adding a comment*.

Note Make sure the current point indicator displays the inspection point you want to edit. If not, use the back or next arrow.

5. Tap the next arrow to continue to the next inspection point.

Note The camera can be configured to automatically continue to the next inspection point after saving an image, see section 15.4 *Configuration*.

6. When you have completed the last inspection point in the route, a dialog box is displayed.
 - To lock the inspection, select *Lock*.
 - If you want to make any additional changes to the inspection, select *Cancel*. You make the changes from the inspection list, see section 15.3.7 *Inspection list*.

7. Continue the inspection until you have completed all inspection points in all routes. You can at any point open the inspection list to see an overview of the routes and their progress, see section 15.3.7 *Inspection list*.

-
- When you have completed the inspection, transfer the inspection results to a computer for post-processing. For more information, see section 15.3.9 *Transferring inspection results*.

15.3.3 Editing inspection point data

You can edit the data for the inspection point displayed by the current point indicator.

To go to another inspection point, use the back or next arrow or select the inspection point from the inspection list, see section 15.3.7 *Inspection list*.

15.3.3.1 Setting the status

- Tap the current point indicator. This displays a drop-down menu.
- Tap the status you want to set. The set status is indicated by a check mark in the menu and by a color in the current point indicator.

Note

- The available statuses are defined by the inspection route file.
- Depending on the inspection route configuration, it may be necessary to take an image before a status can be set.

15.3.3.2 Deleting an image

- Tap the current point indicator. This displays a drop-down menu.
- Tap  to delete the image. This displays a dialog box.
- To delete the image, tap *Delete*.

15.3.3.3 Adding a comment

- Tap the current point indicator. This displays a drop-down menu.
- Tap *Add comment*. This displays a soft keyboard.
- Enter text by touching the screen.
- When completed, tap *Done*.
- The comment is displayed in the drop-down menu. You can also see the comment by tapping the document icon.

15.3.4 Saving an image

When you take an image, the camera automatically saves it to the memory card. The image is stored in a folder with the name of the current inspection route.

You can take and save multiple images of the inspection point.

Note For every new image, make sure that the current point indicator displays the inspection point you want to add the image to. If not, use the back or next arrow or select the inspection point from the inspection list, see section 15.3.7 *Inspection list*.

15.3.5 Recording a video clip

You can record and save video clips of the inspection point. For more information, see section 12.1 *Record a video*.

Note Make sure that the current point indicator displays the inspection point you want to add the video to. If not, use the back or next arrow or select the inspection point from the inspection list, see section 15.3.7 *Inspection list*.

15.3.6 Viewing and editing inspection images

You can view and edit the inspection images in the image archive.

Note It is not possible to edit the inspection point data in the image archive. To edit the inspection point data, see section 15.3.3 *Editing inspection point data*.

15.3.7 Inspection list

In the inspection list, you can see the progress of the inspection routes and review the inspection point results.

To see the progress and review the results, do the following:

1. Tap the current point indicator. This displays a drop-down menu.
2. Tap *Inspection list*. This displays a list with all inspection routes and their progress.
3. Tap an item in the list to display the next level in the inspection route structure.
4. When you reach a level with inspection points, you can see their status and if they have any images associated.
5. To make changes to an inspection point, tap the inspection point in the list. This takes you to the live view for that inspection point.

Note You can only make changes to inspection points in unlocked inspection routes.

15.3.8 Adding an inspection point

If the need for another inspection point arises during the inspection, you can add the inspection point directly in the camera. The new inspection point will be added to the inspection route file and the inspection data you capture for the new inspection point will be saved together with the results from the other inspection points in the route.

To add an inspection point, do the following:

1. Tap the current point indicator. This displays a drop-down menu.
2. Tap *Inspection list*. This displays a list with all inspection routes.
3. In the list, tap the inspection route where you want to add the inspection point. This displays the next level in the route structure.
4. Continue to tap an item in the list until you reach the level where you want to add the inspection point.
5. Tap *Edit* to enter edit mode.
6. Tap the  icon on an item. The new inspection point will be added below this item.
7. Enter the name of the new inspection point.
8. Select to add the new item as an inspection point.
9. Tap *Done* to exit edit mode.

15.3.9 Transferring inspection results

The inspection results are stored on the memory card:

- The inspection route file (.xml) in the root folder includes the data (status, comments, and image file path) for all inspection points.
- The DCIM folder includes folders with the images for each route.

You can upload the inspection results to your FLIR Ignite account or transfer the result files manually using the USB cable or the memory card. You can also open the results from the memory card and save them to a computer using FLIR Thermal Studio.

When you have transferred and safely stored the inspection results, you may want to remove the inspection route file and images from the camera.

15.3.9.1 Upload results to FLIR Ignite

1. Make sure the camera is connected to the internet.
2. Make sure the camera is paired with your FLIR Ignite account.
3. Select  (*Settings*) > *Save options & storage* > *Inspection route* > *Upload inspection route*.
4. The camera now creates a compressed file (.route), which includes the inspection route file (.xml) and the image folders. The camera then uploads the compressed file (.route) to your FLIR Ignite account.

15.3.9.2 Move results manually

If you transfer the inspection results manually to a computer, you must move both the inspection route file (.xml) and the images in their route folders. It is important to maintain the DCIM folder structure.

1. Connect the camera to the computer with a USB cable or insert the memory card into the computer.
2. On the computer, create a folder for the inspection results. In that folder, create a subfolder named DCIM.
3. From the root of the memory card, transfer the inspection route file (.xml) to the inspection results folder on the computer.
4. From the DCIM folder on the memory card, transfer the image folders to the DCIM subfolder on the computer.

15.3.9.3 Remove results from camera

When you have transferred and safely stored the inspection results, you may want to remove or replace the inspection route file on the memory card. If this is not done, the camera will continue from the first uncompleted inspection point in the previous inspection when you start an inspection.

If you choose to keep, remove, or replace the current inspection route file depends on your inspection work flow and how your inspection route is designed. Some examples:

- You have uploaded some results, but not yet completed the entire inspection. You keep the current inspection route file (.xml) and continue with your inspection.
- You have an inspection route file with inspections for each day of the week and you have just transferred the results from the Monday inspection. You keep the current inspection route file (.xml) to be ready for the Tuesday inspection.
- Next time you use the camera, you will do a new inspection. You remove the current inspection route file (.xml) and add a new inspection route file (.xml) file without any data to the root folder on the memory card.

Note Do not add multiple inspection route files (.xml) in the root folder on the memory card.

You may also want to remove the inspection image folders and/or the inspection images from the DCIM folder on the memory card. The camera will create new image folders when a new inspection starts.

15.4 Configuration

The behavior of the camera during the inspection route is controlled via settings in the inspection route file. It is possible to override these settings in the camera.

The camera behavior settings can be configured via the *Settings* menu. Select  (*Settings*) > *Save options & storage* > *Inspection route* > *Configure*.

Configure menu:

- *Follow Inspection route*: Select the check box to use the configuration from the inspection route file. Deselect the check box to make it possible to override the settings in the inspection route file.
- *Auto next*: This setting defines if the camera after saving an image automatically will set the default status and step to the next inspection point. If most inspection points will have the default status, you will save inspection time by selecting the check box. If you often want to set the status or add comments to the inspection points, it may be more convenient to deselect the check box.
- *Default status*: This submenu is used to select the status to be set when an image is saved. The options in the submenu come from the inspection route file.
- *Require image*: This setting defines if the operator must save an image before it is possible to set the status of an inspection point.

- *Delete empty inspection points*: This setting defines if all empty inspection points (no image and no status) will be removed from the inspection route file when the operator locks an inspection.

15.5 Creating an inspection route





The inspection route is defined by an XML file. The inspection route XML file specifies the route structure, consisting of multiple levels of nodes (sites/assets) and inspection points.

The inspection route file also defines the available statuses and the configuration of the camera behavior.

The inspection route file can be created using one of the following methods:

- The FLIR Thermal Studio application.
- Your own solution. The FLIR Thermal SDK can be used to build your own export/import software or to interface your existing asset management system.
- Create a file in the camera.
- Manually edit an XML file.

15.5.1 Creating an inspection route in the camera

1. Make sure that there is no inspection route XML file on the memory card.
2. Select  (*Settings*) > *Save options & storage* > *Inspection route* > *Getting started* > *Create an empty Inspection route*.
This places a basic XML file on the memory card.
3. In live mode, tap the current point indicator. This displays a drop-down menu.
4. Tap *Inspection list*. This displays a list with a node placeholder.
5. Tap *Edit* to enter edit mode.
6. In edit mode, use the following buttons to build the inspection route:
 - Tap  to add a new item below the selected one. You can select the name of the new item and select if the new item is a node or an inspection point.
 - Tap  to delete the selected item and all of its dependents.
 - Tap  to add comments to the node. These comments will apply to all of its dependents.
7. Tap *Done* to exit edit mode.
8. To make changes to the camera behavior configuration, see section 15.4 *Configuration*.
9. When the inspection route is completed, make sure to copy the XML file on the memory card to a computer for future use. When you start an inspection in the camera, the inspection data will be written to the XML file on the memory card.

15.5.2 Manually editing an XML file

An example or empty XML file can be created on the memory card in the camera. This file can be used as a basis when manually editing an XML file.

1. Make sure that there is no inspection route XML file on the memory card.
2. Select  (*Settings*) > *Save options & storage* > *Inspection route* > *Getting started*.

3. Select one of the following:

- *Create an example Inspection route*: This creates an example XML file with a multi-level structure on the memory card.
- *Create an empty Inspection route*: This creates a basic XML file on the memory card.

4. Transfer the example XML file to a computer for editing.

On the *Settings* menu, you can set up the camera according to your preferences and view information about your camera.

The *Settings* menu includes the following:

- *FLIR Ignite*
- *Connections*
- *Quantification*
- *Multi-Rec settings*
- *Camera temperature range*
- *Save options & storage*
- *Device settings*

16.1 FLIR Ignite

Sign in to FLIR Ignite and view information about the FLIR Ignite account the camera is paired with.

Enable/disable automatic upload of images.

For more information about FLIR Ignite and online storage of images, see section 14.3 *Cloud connectivity*.

16.2 Connections

Connect the camera to a Wi-Fi network or set up the camera as a wireless access point. For more information, see section 14.1 *Wi-Fi*.

Pair the camera with a Bluetooth device. For more information, see section 14.2 *Bluetooth*.

Advanced settings for firewall, trusted applications, and streaming authentication.

16.3 Quantification

- *Save radiometric recording*: Enable/disable recording of a radiometric video (*.csq) after the quantification measurement.
- *Flow rate*: Select the unit used in the flow rate quantification measurement.

16.4 Multi-Rec settings

Set up a recording sequence in different image modes (IR, HSM, Digital camera). For more information, see section 12.3 *Multi-Rec*

16.5 Camera temperature range

The camera is calibrated for different temperature ranges. The available temperature range options depend on the camera model.

What temperature range to select depends on the application (gas detection or temperature measurement) and the thermal conditions in the scene. For more information, see section 7.2 *Temperature range*.

16.6 Save options & storage

- *Inspection route*: Activate and configure the Inspection Route function. See also section 15 *Inspection Route*.
- *Preview image before saving*: Set up the camera to display a preview image before an image is saved. See also section 11.1.1 *Preview an image*.
- *Add annotation after saving*: Set up the camera to display an annotation tool or the Annotation menu. See also section 11.2 *Annotate an image*.
- *Video compression*: Storage format for video files.
 - *Mpeg (*.mpg)*: Mpeg recordings cannot be edited after the file has been saved.
 - *Radiometric storage (*.csq)*: An .csq file supports full radiometry but is only supported by FLIR Systems software. The file does not include any visual image information. With this setting, it is not possible to record video in *HSM* mode. Also, only the image mode *Thermal* is supported when recording video.
 - *Uncompressed radiometric (*.seq)*: A .seq file supports full radiometry but is only supported by FLIR software.

Note This setting does not apply to Multi-Rec video files. Multi-Rec video recordings are always saved in MPEG (*.mp4) format.

- *Video frame rate*: Frame rate for video recordings.
- *Video microphone*: This setting is used to turn on/off the Bluetooth headset microphone.
- *Photo as separate JPEG*: A visual image is always saved in the same JPEG file as the thermal image. Enabling this setting saves an extra low-resolution visual image as a separate JPEG file.
- *Digital camera*: Turn on/off the digital camera. Turning off the digital camera can, for example, be required in restricted areas.
- *File naming format*: Applies to new image and video files. The setting has no impact on already saved files.
 - *DCF*: DCF (Design rule for Camera File system) is a standard that specifies the naming method of image files (and much more). With this setting, the name of a saved image/video file will be FLIRxxxx, where xxxx is an incremental counter. Example: FLIR0001. (When the counter has reached 9999, the filename will change to IR_yyyyy.jpg.)
 - *Date prefix*: A prefix will be added to the filename, including the date and the text “IR_” for images and “MOV_” for videos. The date format will follow the *Date & time format* setting, see section 16.7 *Device settings*.
 - *Date + time only*: The filename will only include the date and time.

Note With the *Date prefix* and *Date + time only* settings, the files may not automatically be detected by third-party applications.

- *Delete all saved files...*: This displays a dialog box where you can select to permanently delete all saved files on the memory card.

16.7 Device settings

- *Language, time & units*: Select the language, units, and date and time formats to be used in the camera.
- *Display settings*
 - *Image overlay information*: Select what information the camera will display as an overlay on the image. See also section 5.5 *Image overlay*.

Note This setting only specifies what information to display on the image. All image information is always saved to the image file and is available in the image archive.

- *Screen brightness*: Adjust the brightness of the screen. Enable/disable automatic adjustment.

-
- Note** You can also adjust the screen brightness on the Quick menu, see section 5.4 *Quick menu*.
- *Viewfinder brightness*: Adjust the brightness of the viewfinder.
 - *Update*: Check for updates and install new firmware versions. The camera must be connected to the internet. See also section 18 *Updating the camera*.
 - *Geolocation*:
 - *GPS*: Enable/disable the GPS.
 - *Lamp & laser*:
 - *Enable lamp & laser*: Enable the camera lamps and the laser.
 - *Enable lamp & laser + Use lamp as flash*: The camera lamps will flash when an image is saved.
 - *Disable all*: Disable the camera lamps, laser, and flash function.
 - *User interface options*:
 - *Auto adjustment region*: Set the region used for auto image adjustment. See also section 7.3.4 *Auto adjustment region*.
 - *Manual adjustment using touch*: Enable/disable the touch functionality for manual image adjustments. See also section 7.3.2 *Manual adjustment by touching the screen*.
 - *Manual adjustment mode*: Select the type of manual image adjustment mode (applicable for the joystick). See also section 7.3.3 *Manual adjustment using the joystick*.
 - *Emissivity mode*: Select to enter the emissivity by value or material. See also section 10.5 *Measurement parameters*.
 - *Color theme*: Select light or dark theme for the user interface.
 - *Volume*: This setting is used to control the volume of the Bluetooth headset speaker.
 - *Reset options*:
 - *Reset default camera mode...*: This will affect the image mode, color palette, measurement tools, and measurement parameters. Saved images will not be affected.
 - *Reset device settings to factory default...*: This will affect all camera settings, including regional settings. Saved videos/images will not be affected. The camera will be restarted and you will be prompted to set the regional settings.
 - *Reset image counter...*: This will reset the numbering of the filenames. The next number will be based on the highest existing filename number in the image archive.
- Note** When a reset option is selected, a dialog box is displayed with more information. You can choose to execute the reset action or to cancel.
- *Camera information*: Information about the camera and lens.
 - *Regulatory*: Regulatory information.

17.1 General check

The following general check process ensures that the camera can detect the intended gas compounds with the same sensitivity as when originally manufactured.

Make sure that:

1. The camera powers on.
2. The camera produces a live thermal image.
3. The camera does not report any error messages on startup.
4. The camera focuses properly.
5. The camera is able to activate the High Sensitivity Mode (HSM).

17.2 Clean the camera

17.2.1 Camera housing, cables, and other items

Use one of these liquids:

- Warm water
- A weak detergent solution

Equipment:

- A soft cloth

Follow this procedure:

1. Soak the cloth in the liquid.
2. Twist the cloth to remove excess liquid.
3. Clean the part with the cloth.



CAUTION

Do not apply solvents or similar liquids to the camera, the cables, or other items. This can cause damage.

17.2.2 Infrared lens

Use one of these liquids:

- A commercial lens cleaning liquid with more than 30% isopropyl alcohol.
- 96% ethyl alcohol (C₂H₅OH).

Equipment:

- Cotton wool



CAUTION

If you use a lens cleaning cloth it must be dry. Do not use a lens cleaning cloth with the liquids that are listed above. These liquids can cause material on the lens cleaning cloth to become loose. This material can have an unwanted effect on the surface of the lens.

Follow this procedure:

1. Soak the cotton wool in the liquid.
2. Twist the cotton wool to remove excess liquid.
3. Clean the lens one time only and discard the cotton wool.



WARNING

Make sure that you read all applicable MSDS (Material Safety Data Sheets) and warning labels on containers before you use a liquid: the liquids can be dangerous.

**CAUTION**

- Be careful when you clean the infrared lens. The lens has a delicate anti-reflective coating.
- Do not clean the infrared lens too vigorously. This can damage the anti-reflective coating.

17.2.3 Infrared detector

Even small amounts of dust on the infrared detector can result in major blemishes in the image. To remove any dust from the detector, follow the procedure below.

Note

- This section only applies to cameras where removing the lens exposes the infrared detector.
- In some cases the dust cannot be removed by following this procedure: the infrared detector must be cleaned mechanically. This mechanical cleaning must be carried out by an authorized service partner.

**CAUTION**

In Step 2 below, do not use pressurized air from pneumatic air circuits in a workshop, etc., as this air usually contains oil mist to lubricate pneumatic tools.

Follow this procedure:

1. Remove the lens from the camera.
2. Use pressurized air from a compressed air canister to blow off the dust.

17.3 Cooler maintenance**17.3.1 General**

The microcooler is designed to provide maintenance-free operation for many thousands of hours. The microcooler contains pressurized helium gas.

After several thousand hours of operation the gas pressure decreases, and cooler service is required to restore cooler performance. The cooler also contains micro ball bearings, which may exhibit wear by becoming louder.

17.3.2 Signs to watch for

The FLIR Systems microcooler is equipped with a closed-loop speed regulator, which adjusts the cooler motor speed to regulate the detector temperature.

Typically, the cooler runs at maximum speed for 7–10 minutes (depending on model), and then slows to about 40% of maximum speed. As the gas pressure degrades, the motor continues at maximum speed for longer and longer periods to attain operating temperature

Eventually, as the helium pressure decreases, the motor will lose the ability to achieve and/or maintain operating temperature. When this occurs, the camera must be returned to FLIR Systems Customer Service Department for service.

17.4 Camera calibration

- Gas detection: No re-calibration recommendation. The ability to detect gases is not influenced by the calibration and will not degrade over time.
- Temperature measurement: For applications where infrared cameras are used to measure temperature, such as in predictive maintenance of electrical or mechanical assets, we recommend a yearly calibration. With a calibration certificate containing measurement data, you will be able to track the performance of your camera and decide the most appropriate time to send it in for adjustment.

- Delta T measurement for gas detection: The camera uses relative Delta T measurements to ensure the conditions are acceptable for proper gas detection, so absolute measurement accuracy is not as important as it is for temperature measurement applications. We recommend that you send in the camera for calibration adjustment if its readings are outside of established accuracy specifications.
- Gas Leak Quantification: The quantification method uses the radiometrically calibrated data from the camera to create a relative Delta T reading, so the accuracy of the quantification results depends on the measurement accuracy of the camera. We recommend the camera to be calibrated yearly and/or a temperature measurement verification is carried out using a traceable temperature source such as blackbody or known temperature surface. We recommend that you send in the camera for calibration adjustment if its readings are outside of established accuracy specifications.

To take advantage of our latest camera firmware, it is important that you keep your camera updated.

There are several ways to update the camera:

- When the camera is connected to the internet, the camera automatically searches for firmware updates. Via the *Settings* menu, you can download and install new firmware versions Over-The-Air (OTA) when they become available.
- Connect the camera to a computer with a USB cable and use the FLIR Camera Updater application to update the camera.
- Download an update package and update the camera manually. For more information, go to <https://support.flir.com>.

18.1 Update the camera Over-The-Air (OTA)

Note If a new firmware version is available, there will be a notification on the *Settings* menu.

To install a new firmware version, do the following:

1. Make sure the camera battery is fully charged.
2. Make sure the camera has Wi-Fi enabled and is connected to the internet.
3. Select *Settings* > *Device settings* > *Update*.
4. If an update is available, select *Download* to download the installation package.
5. Select *Install* to start the installation.
6. When the installation is completed, the camera will automatically restart.

18.2 Update via USB cable with the FLIR Camera Updater

The FLIR Camera Updater is a Windows application used to update the camera.

To update your camera, you must log in to your FLIR account or sign up for a new account. You must also register the camera.

18.2.1 Install the FLIR Camera Updater

1. Go to <https://support.flir.com>. Find the software download area and search for FLIR Camera Updater.
2. Download the FLIR Camera Updater installer package.
3. Start the installation by double-clicking the executable installer file.
4. Follow the instructions in the setup wizard.

18.2.2 Connect the camera

1. Connect the camera to the computer, using the USB cable.
2. Turn on the camera.
3. Run the FLIR Camera Updater application.
4. Sign in to your FLIR account or sign up for a new account.
5. The application automatically connects to the camera.
6. If the camera is not registered, select *Product registration* and complete the registration.
7. If a newer firmware version is available, you can select to update the connected camera.

18.2.3 Update notifications

The FLIR Camera Updater can send notifications if there is a new update available for your previously connected devices.

Waste of Electrical and Electronic Equipment (WEEE) poses a risk to human health and the environment when not disposed of properly. This product should not be discarded as unsorted waste but must be sent to separate collection facilities for recovery and recycling. More information is available from the relevant local authority.



19.1 Battery removal

Before disposal of the camera, remove the battery.

To remove the battery, do the following:

1. Open the cover at the rear of the camera.
2. Use the handle to pull out the battery.

Before you discard the battery, apply insulation to the terminals with adhesive tape or equivalent materials.

20.1 Legal disclaimer

For warranty terms, refer to <https://www.flir.com/warranty>.

20.2 Export controls

Products described herein may be subject to export regulations.

This document does not contain export-controlled information.

20.3 Patents

This product is protected by patents, design patents, patents pending, or design patents pending. Refer to the FLIR Systems' patent registry:

<https://www.flir.com/patentnotices>

20.4 Quality assurance

The Quality Management System under which these products are developed and manufactured has been certified in accordance with the ISO 9001 standard.

FLIR Systems is committed to a policy of continuous development; therefore we reserve the right to make changes and improvements on any of the products without prior notice.

20.5 Third-party licenses

Information about third-party licenses is available in the user interface of the product.

20.6 Usage statistics

FLIR Systems reserves the right to gather anonymous usage statistics to help maintain and improve the quality of our software and services.

20.7 Copyright

© 2024 FLIR Systems, Inc. All rights reserved worldwide. No parts of the software including source code may be reproduced, transmitted, transcribed or translated into any language or computer language in any form or by any means, electronic, magnetic, optical, manual or otherwise, without the prior written permission of FLIR Systems.

The documentation must not, in whole or part, be copied, photocopied, reproduced, translated or transmitted to any electronic medium or machine readable form without prior consent, in writing, from FLIR Systems.

Names and marks appearing on the products herein are either registered trademarks or trademarks of FLIR Systems and/or its subsidiaries. All other trademarks, trade names or company names referenced herein are used for identification only and are the property of their respective owners.



Website
<http://www.flir.com>

Customer support
<http://support.flir.com>

Copyright
© 2024, FLIR Systems, Inc. All rights reserved worldwide.

Disclaimer
Specifications subject to change without further notice. Models and accessories subject to regional market considerations. License procedures may apply. Products described herein may be subject to US Export Regulations. Please refer to exportquestions@flir.com with any questions.

Publ. No.: T810605
Release: AG
Commit: 99908
Head: 99908
Language: en-US
Modified: 2024-10-24
Formatted: 2024-10-24