

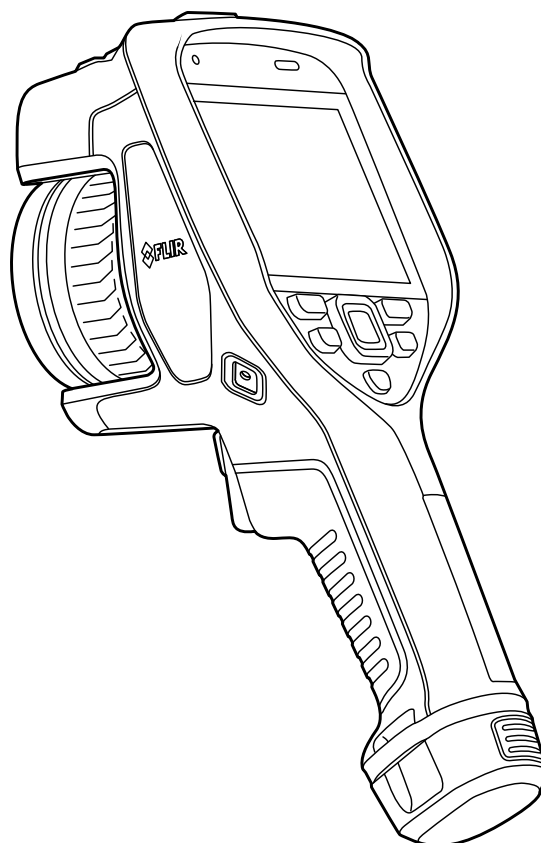

User's manual FLIR Exx series



Important note

Before operating the device, you must read, understand, and follow all instructions, warnings, cautions, and legal disclaimers.

Důležitá poznámka

Před použitím zařízení si přečtěte veškeré pokyny, upozornění, varování a vyvázání se ze záruky, ujistěte se, že jim rozumíte, a řiďte se jimi.

Viktig meddelelse

Før du betjener enheden, skal du læse, forstå og følge alle anvisninger, advarsler, sikkerhedsforanstaltninger og ansvarsfraskrivelser.

Wichtiger Hinweis

Bevor Sie das Gerät in Betrieb nehmen, lesen, verstehen und befolgen Sie unbedingt alle Anweisungen, Warnungen, Vorsichtshinweise und Haftungsausschlüsse

Σημαντική σημείωση

Πριν από τη λειτουργία της συσκευής, πρέπει να διαβάσετε, να κατανοήσετε και να ακολουθήσετε όλες τις οδηγίες, προειδοποιήσεις, προφυλάξεις και νομικές αποποιήσεις.

Nota importante

Antes de usar el dispositivo, debe leer, comprender y seguir toda la información sobre instrucciones, advertencias, precauciones y renuncias de responsabilidad.

Tärkeä huomautus

Ennen laitteen käyttämistä on luettava ja ymmärrettävä kaikki ohjeet, vakavat varoitukset, varoitukset ja lakitiedotteet sekä noudatettava niitä.

Remarque importante

Avant d'utiliser l'appareil, vous devez lire, comprendre et suivre l'ensemble des instructions, avertissements, mises en garde et clauses légales de non-responsabilité.

Fontos megjegyzés

Az eszköz használatá elótt figyelmesen olvassa el és tartsa be az összes utasítást, figyelmeztetést, óvintézkedést és jogi nyilatkozatot.

Nota importante

Prima di utilizzare il dispositivo, è importante leggere, capire e seguire tutte le istruzioni, avvertenze, precauzioni ed esclusioni di responsabilità legali.

重要な注意

デバイスをご使用になる前に、あらゆる指示、警告、注意事項、および免責条項をお読み頂き、その内容を理解して従ってください。

중요한 참고 사항

장치를 작동하기 전에 반드시 다음의 사용 설명서와 경고, 주의사항, 법적 책임제한을 읽고 이해하며 따라야 합니다.

Viktig

Før du bruker enheten, må du lese, forstå og følge instruksjoner, advarsler og informasjon om ansvarsfraskrivelse.

Belangrijke opmerking

Zorg ervoor dat u, voordat u het apparaat gaat gebruiken, alle instructies, waarschuwingen en juridische informatie hebt doorgelezen en begrepen, en dat u deze opvolgt en in acht neemt.

Ważna uwaga

Przed rozpoczęciem korzystania z urządzenia należy koniecznie zapoznać się z wszystkimi instrukcjami, ostrzeżeniami, przestrogam i uwagami prawnymi. Należy zawsze postępować zgodnie z zaleceniami tam zawartymi.

Nota importante

Antes de utilizar o dispositivo, deverá proceder à leitura e compreensão de todos os avisos, precauções, instruções e isenções de responsabilidade legal e assegurar-se do seu cumprimento.

Важное примечание

До того, как пользоваться устройством, вам необходимо прочитать и понять все предупреждения, предостережения и юридические ограничения ответственности и следовать им.

Viktig information

Innan du använder enheten måste du läsa, förstå och följa alla anvisningar, varningar, försiktighetsåtgärder och ansvarsfriskrivningar.

Önemli not

Cihazı çalıştırmadan önce tüm talimatları, uyarıları, ikazları ve yasal açıklamaları okumalı, anlamalı ve bunlara uymalısınız.

重要注意事項

在操作设备之前，您必须阅读、理解并遵循所有说明、警告、注意事项和法律免责声明。

重要注意事項

操作裝置之前，您務必閱讀、了解並遵循所有說明、警告、注意事項與法律免責聲明。

Table of contents

1	Disclaimers	1
1.1	Legal disclaimer	1
1.2	Export controls	1
1.3	Patents	1
1.4	Quality assurance	1
1.5	Third-party licenses	1
1.6	Usage statistics	1
1.7	Copyright	1
2	Safety information	2
3	Notice to user	6
3.1	Online documentation	6
3.2	Register your camera	6
3.3	Accuracy	6
3.4	Calibration	6
3.5	Training	6
3.6	Important note about this manual	6
3.7	Note about authoritative versions	7
3.8	Disposal of electronic waste	7
4	Customer help	8
4.1	General	8
4.2	Submitting a question	8
4.3	Downloads	8
5	Quick start guide	9
5.1	To keep in mind	9
6	Camera overview	11
6.1	View from the front	11
6.2	View from the rear	12
6.3	Laser distance meter and laser pointer	12
6.3.1	Laser transmitter and receiver	13
6.3.2	Difference in position	13
6.3.3	Laser warning label	14
6.3.4	Laser rules and regulations	14
6.4	Screen elements	14
6.4.1	General	14
6.4.2	Menu system	14
6.4.3	Status icons and indicators	15
6.4.4	Swipe-down menu	15
6.4.5	Image overlay information	16
6.5	Navigating the menu system	17
6.5.1	Navigating using the navigation pad	17
7	Handling the camera	18
7.1	Charging the battery	18
7.1.1	General	18
7.1.2	Using the stand-alone battery charger to charge the battery	18
7.1.3	Using the USB battery charger to charge the battery	18
7.1.4	Charging the battery using a USB cable connected to a computer	19
7.2	Removing the battery	20
7.3	Turning on and turning off the camera	20
7.4	Adjusting the thermal camera focus	21
7.4.1	Manual focus	21
7.4.2	Autofocus	21
7.4.3	Continuous autofocus	22

Table of contents

7.5	Operating the laser distance meter	23
7.5.1	General.....	23
7.5.2	Procedure	23
7.6	Measuring areas.....	24
7.6.1	General.....	24
7.6.2	Procedure	24
7.7	Connecting external devices and storage media	25
7.8	Moving files to a computer	25
7.8.1	Related topics	26
7.9	Programmable button	27
7.9.1	Programmable button options	27
7.10	Using the camera lamp as a flash	28
7.11	Hand strap	29
7.11.1	Mounting the hand strap	30
7.12	Lanyard strap.....	32
7.13	Wrist strap.....	33
7.14	Front protection	34
7.15	Changing camera lenses	35
7.16	Calibrating the lens–camera combination	38
7.16.1	Introduction.....	38
7.16.2	AutoCal procedure	39
7.17	Calibrating the compass.....	40
8	Saving and working with images	41
8.1	About image files	41
8.1.1	General.....	41
8.1.2	File-naming convention	41
8.1.3	Storage capacity	41
8.1.4	About UltraMax.....	41
8.2	Saving an image	42
8.3	Previewing an image	42
8.4	Opening a saved image.....	43
8.5	Editing a saved image.....	43
8.5.1	Related topics	44
8.6	Displaying the image information.....	44
8.7	Zooming an image	44
8.8	Deleting images	44
8.9	Resetting the image counter.....	45
9	Cloud connectivity.....	46
9.1	Uploading to FLIR Ignite	46
9.2	Connecting to internet.....	46
9.2.1	Connecting to Wi-Fi	46
9.2.2	Connecting via Bluetooth	46
9.3	Creating a FLIR Ignite account.....	47
9.4	Pairing with FLIR Ignite.....	47
9.5	Automatic upload.....	47
9.6	Manual upload	47
9.6.1	Uploading an image/video file	47
9.6.2	Uploading multiple files.....	47
9.6.3	Uploading folders.....	48
9.7	Accessing FLIR Ignite	48
10	Working with the image archive.....	49
10.1	General	49
10.2	Opening image and video files	49
10.3	Creating a new folder.....	49
10.4	Renaming a folder.....	50

Table of contents

10.5	Changing the active folder	50
10.6	Moving files between folders	50
10.7	Uploading files and folders.....	50
10.8	Deleting a folder	50
10.9	Deleting an image or video file	51
10.10	Deleting multiple files.....	51
10.11	Deleting all files	51
11	Achieving a good image	52
11.1	General	52
11.2	Adjusting the infrared camera focus	52
11.2.1	Manual focus.....	52
11.2.2	Autofocus	52
11.2.3	Continuous autofocus	52
11.3	Adjusting the infrared image.....	52
11.3.1	General.....	52
11.3.2	Auto adjustment region.....	54
11.3.3	Manual adjustment by touching the screen	54
11.3.4	Manual adjustment by using the navigation pad	55
11.3.5	Manual adjustment in <i>Level, Span</i> mode	56
11.3.6	Manual adjustment in <i>Level, Max, Min</i> mode	56
11.4	Changing the camera temperature range	56
11.5	Changing the color palettes.....	56
11.6	Changing the measurement parameters	58
11.7	Performing a non-uniformity correction (NUC)	58
11.7.1	General.....	58
11.7.2	Performing an NUC manually.....	58
11.8	Hiding all overlay	58
12	Working with image modes.....	60
12.1	General	60
12.2	Image examples	60
12.3	Selecting an image mode	61
13	Working with measurement tools	62
13.1	General	62
13.2	Adding/removing measurement tools	62
13.3	Editing user presets.....	62
13.4	Moving and resizing a measurement tool	63
13.4.1	General.....	63
13.4.2	Moving a spot.....	63
13.4.3	Moving and resizing a box or circle tool	64
13.5	Changing the measurement parameters	64
13.5.1	General.....	64
13.5.2	Types of parameters	64
13.5.3	Recommended values.....	65
13.5.4	Procedure	65
13.6	Displaying values in the result table.....	66
13.7	Creating and setting up a difference calculation	67
13.8	Setting a measurement alarm	67
13.8.1	General.....	67
13.8.2	Types of alarm	67
13.8.3	Alarm signals	67
13.8.4	Procedure	67
14	Working with color alarms and isotherms.....	70
14.1	Color alarms	70
14.1.1	Setting up above, below, and interval alarms	71

Table of contents

	14.1.2 Building isotherms.....	71
15	Annotating images	73
	15.1 General	73
	15.2 Adding a note	73
	15.3 Adding a text comment table	73
	15.3.1 Creating a text comment table template	74
	15.4 Adding a voice annotation.....	75
	15.5 Adding a sketch.....	75
16	Programming the camera (time-lapse)	77
17	Recording video clips	78
	17.1 General	78
	17.2 Recording a video clip.....	78
	17.3 Playing a saved video clip.....	78
18	Inspection Route	79
	18.1 General	79
	18.1.1 Work flow	79
	18.1.2 FLIR Inspection Route Solution user manual	79
	18.1.3 First generation FLIR Inspection Route	79
	18.2 Route file	80
	18.3 Inspection file.....	80
	18.4 User interface	80
	18.4.1 Reference image.....	81
	18.4.2 Drop-down menu	81
	18.5 Perform inspection	82
	18.5.1 General.....	82
	18.5.2 Add the Route file to the memory card	82
	18.5.3 Inspection settings.....	82
	18.5.4 Start an inspection.....	82
	18.5.5 Capture inspection data.....	83
	18.5.6 Save an image.....	84
	18.5.7 Inspection images	84
	18.5.8 Inspection list	84
	18.5.9 Edit inspection point data	84
	18.5.10 Record a video clip	85
	18.5.11 Transfer inspection results.....	85
	18.6 Configuration	85
	18.7 Use settings and parameters from reference images	86
19	Screening alarm.....	87
	19.1 General	87
	19.2 Work flow	87
	19.2.1 Activate and configure the screening alarm	87
	19.2.2 Record reference samples	88
	19.2.3 Perform the screening	88
20	Configuring Wi-Fi	89
	20.1 Setting up a wireless access point	89
	20.2 Connecting the camera to Wi-Fi	89
21	Pairing Bluetooth devices.....	90
22	Fetching data from external FLIR meters	91
	22.1 General	91
	22.2 Technical support for external meters	91
	22.3 Procedure	91
	22.4 Typical moisture measurement and documentation procedure	92
	22.5 More information	92

Table of contents

23	Camera settings	93
23.1	FLIR Ignite	93
23.2	Recording mode	93
23.3	Connections	93
23.4	Camera temperature range	94
23.5	Save options & storage	94
23.6	Device settings.....	95
24	Cleaning the camera	98
24.1	Camera housing, cables, and other items.....	98
24.2	Infrared lens	98
24.3	Infrared detector	98
25	Updating the camera	100
25.1	Prepare for update Over-The-Air (OTA)	100
25.2	Update the camera Over-The-Air (OTA)	100
25.3	Update via USB cable with the FLIR Camera Updater	100
25.3.1	Install the FLIR Camera Updater.....	100
25.3.2	Connect the camera	100
25.3.3	Update notifications	101
26	Mechanical drawings	102
27	Declaration of conformity	106
28	About calibration	107
28.1	Introduction	107
28.2	Definition—what is calibration?	107
28.3	Camera calibration at FLIR Systems	107
28.4	The differences between a calibration performed by a user and that performed directly at FLIR Systems.....	108
28.5	Calibration, verification and adjustment.....	108
28.6	Non-uniformity correction.....	109
28.7	Thermal image adjustment (thermal tuning)	109
29	About FLIR Systems	110
29.1	More than just an infrared camera	111
29.2	Sharing our knowledge	111
29.3	Supporting our customers.....	112

1.1 Legal disclaimer

For warranty terms, refer to <https://www.flir.com/warranty>.

1.2 Export controls

Products described herein may be subject to export regulations.

This document does not contain export-controlled information.

1.3 Patents

This product is protected by patents, design patents, patents pending, or design patents pending. Refer to the FLIR Systems' patent registry:

<https://www.flir.com/patentnotices>

1.4 Quality assurance

The Quality Management System under which these products are developed and manufactured has been certified in accordance with the ISO 9001 standard.

FLIR Systems is committed to a policy of continuous development; therefore we reserve the right to make changes and improvements on any of the products without prior notice.

1.5 Third-party licenses

Information about third-party licenses is available in the user interface of the product.

1.6 Usage statistics









FLIR Systems reserves the right to gather anonymous usage statistics to help maintain and improve the quality of our software and services.

1.7 Copyright













© 2023 FLIR Systems, Inc. All rights reserved worldwide. No parts of the software including source code may be reproduced, transmitted, transcribed or translated into any language or computer language in any form or by any means, electronic, magnetic, optical, manual or otherwise, without the prior written permission of FLIR Systems.













The documentation must not, in whole or part, be copied, photocopied, reproduced, translated or transmitted to any electronic medium or machine readable form without prior consent, in writing, from FLIR Systems.

Names and marks appearing on the products herein are either registered trademarks or trademarks of FLIR Systems and/or its subsidiaries. All other trademarks, trade names or company names referenced herein are used for identification only and are the property of their respective owners.

 WARNING
<p>Applicability: Class B digital devices.</p> <p>This equipment has been tested and found to comply with the limits for a Class B digital device, pursuant to Part 15 of the FCC Rules. These limits are designed to provide reasonable protection against harmful interference in a residential installation. This equipment generates, uses and can radiate radio frequency energy and, if not installed and used in accordance with the instructions, may cause harmful interference to radio communications. However, there is no guarantee that interference will not occur in a particular installation. If this equipment does cause harmful interference to radio or television reception, which can be determined by turning the equipment off and on, the user is encouraged to try to correct the interference by one or more of the following measures:</p> <ul style="list-style-type: none"> • Reorient or relocate the receiving antenna. • Increase the separation between the equipment and receiver. • Connect the equipment into an outlet on a circuit different from that to which the receiver is connected. • Consult the dealer or an experienced radio/TV technician for help.
 WARNING
<p>Applicability: Digital devices subject to 15.19/RSS-GEN.</p> <p>NOTICE: This device complies with Part 15 of the FCC Rules and with Industry Canada licence-exempt RSS standard(s). Operation is subject to the following two conditions:</p> <ol style="list-style-type: none"> 1. this device may not cause harmful interference, and 2. this device must accept any interference received, including interference that may cause undesired operation.
 WARNING
<p>Applicability: Digital devices subject to 15.21.</p> <p>NOTICE: Changes or modifications made to this equipment not expressly approved by FLIR Systems may void the FCC authorization to operate this equipment.</p>
 WARNING
<p>Applicability: Digital devices subject to 2.1091/2.1093/KDB 447498/RSS-102.</p> <p>Radiofrequency radiation exposure Information: The radiated output power of the device is far below the FCC radio frequency exposure limits. Nevertheless, the device should be used in such a manner that the potential for human contact during normal operation is minimized.</p>
 WARNING
<p>This device is granted pursuant to the Japanese Radio Law (電波法) and the Japanese Telecommunications Business Law (電気通信事業法). This device should not be modified (otherwise the granted designation number will become invalid)</p>
 WARNING
<p>Do not look directly into the laser beam. The laser beam can cause eye irritation.</p>
 WARNING
<p>Do not point the camera at the face of a person when the continuous autofocus function is on. The camera uses laser distance measurements (that are continuous) for the focus adjustments. The laser beam can cause eye irritation.</p>
 WARNING
<p>Do not point the camera at the face of a person when you use the autofocus function. You can set the camera to use a laser distance measurement for the focus adjustment. The laser beam can cause eye irritation.</p>

Safety information

 WARNING
Do not disassemble or do a modification to the battery. The battery contains safety and protection devices which, if damage occurs, can cause the battery to become hot, or cause an explosion or an ignition.
 WARNING
If there is a leak from the battery and you get the fluid in your eyes, do not rub your eyes. Flush well with water and immediately get medical care. The battery fluid can cause injury to your eyes if you do not do this.
 WARNING
Do not continue to charge the battery if it does not become charged in the specified charging time. If you continue to charge the battery, it can become hot and cause an explosion or ignition. Injury to persons can occur.
 WARNING
Only use the correct equipment to remove the electrical power from the battery. If you do not use the correct equipment, you can decrease the performance or the life cycle of the battery. If you do not use the correct equipment, an incorrect flow of current to the battery can occur. This can cause the battery to become hot, or cause an explosion. Injury to persons can occur.
 WARNING
Make sure that you read all applicable MSDS (Material Safety Data Sheets) and warning labels on containers before you use a liquid. The liquids can be dangerous. Injury to persons can occur.
 CAUTION
Do not point the infrared camera (with or without the lens cover) at strong energy sources, for example, devices that cause laser radiation, or the sun. This can have an unwanted effect on the accuracy of the camera. It can also cause damage to the detector in the camera.
 CAUTION
Do not use the camera in temperatures more than 50°C (122°F), unless other information is specified in the user documentation or technical data. High temperatures can cause damage to the camera.
 CAUTION
Do not attach the batteries directly to a car's cigarette lighter socket, unless FLIR Systems supplies a specific adapter to connect the batteries to a cigarette lighter socket. Damage to the batteries can occur.
 CAUTION
Do not connect the positive terminal and the negative terminal of the battery to each other with a metal object (such as wire). Damage to the batteries can occur.
 CAUTION
Do not get water or salt water on the battery, or permit the battery to become wet. Damage to the batteries can occur.
 CAUTION
Do not make holes in the battery with objects. Damage to the battery can occur.
 CAUTION
Do not hit or cause shocks to the battery. Damage to the battery can occur.

 CAUTION
Do not put the batteries in or near a fire, or into direct sunlight. When the battery becomes hot, the built-in safety equipment becomes energized and can stop the battery charging procedure. If the battery becomes hot, damage can occur to the safety equipment and this can cause more heat, damage or ignition of the battery.
 CAUTION
Do not put the battery on or near fires, stoves, or other high-temperature locations. Damage to the battery and injury to persons can occur.
 CAUTION
Do not solder directly onto the battery. Damage to the battery can occur.
 CAUTION
Do not use the battery if, when you use, charge, or put the battery in storage, there is an unusual smell from the battery, the battery feels hot, changes color, changes shape, or is in an unusual condition. Speak with your sales office if one or more of these problems occurs. Damage to the battery and injury to persons can occur.
 CAUTION
Only use a specified battery charger when you charge the battery. Damage to the battery can occur if you do not do this.
 CAUTION
Only use a specified battery for the camera. Damage to the camera and the battery can occur if you do not do this.
 CAUTION
The temperature range through which you can charge the battery is $\pm 0^{\circ}\text{C}$ to $+45^{\circ}\text{C}$ ($+32^{\circ}\text{F}$ to $+113^{\circ}\text{F}$), except for the Korean market where the approved range is $+10^{\circ}\text{C}$ to $+45^{\circ}\text{C}$ ($+50^{\circ}\text{F}$ to $+113^{\circ}\text{F}$). If you charge the battery at temperatures out of this range, it can cause the battery to become hot or to break. It can also decrease the performance or the life cycle of the battery.
 CAUTION
The temperature range through which you can remove the electrical power from the battery is -15°C to $+50^{\circ}\text{C}$ ($+5^{\circ}\text{F}$ to $+122^{\circ}\text{F}$), unless other information is specified in the user documentation or technical data. If you operate the battery out of this temperature range, it can decrease the performance or the life cycle of the battery.
 CAUTION
When the battery is worn, apply insulation to the terminals with adhesive tape or equivalent materials before you discard it. Damage to the battery and injury to persons can occur if you do not do this.
 CAUTION
Remove any water or moisture on the battery before you install it. Damage to the battery can occur if you do not do this.
 CAUTION
Do not apply solvents or equivalent liquids to the camera, the cables, or other items. Damage to the battery and injury to persons can occur.
 CAUTION
Be careful when you clean the infrared lens. The lens has an anti-reflective coating which is easily damaged. Damage to the infrared lens can occur.

**CAUTION**

Do not use too much force to clean the infrared lens. This can cause damage to the anti-reflective coating.

**CAUTION**

The 5 GHz band is only allowed for indoor use in Japan and Canada.

Note The encapsulation rating is only applicable when all the openings on the camera are sealed with their correct covers, hatches, or caps. This includes the compartments for data storage, batteries, and connectors.

3.1 Online documentation

Our manuals are continuously updated and published online.

To access the FLIR Exx series user manual and other product documentation, go to <http://support.flir.com/resources/5v82>.

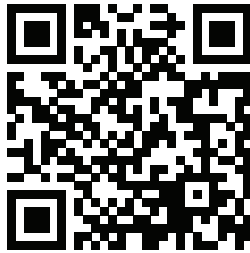

To access the manuals for our other products, as well as manuals for our discontinued products, go to <https://support.flir.com/resources/app>.

3.2 Register your camera

Register your camera to receive an extended warranty and other related benefits.

To register the camera, go to <http://support.flir.com/camreg>.

To access the registration form, you must log in to your FLIR account or sign up for a new account.

You will also need the serial number of your camera. The serial number is displayed by the registration wizard in the camera.

To start the registration wizard, turn on the camera and select *Settings > Device settings > Camera information > Register camera*.

To complete the registration, you must enter a verification code into the camera. The code is available in your FLIR account, under *My Products*.

3.3 Accuracy

For very accurate results, we recommend that you wait 5 minutes after you have started the camera before measuring a temperature.

3.4 Calibration

We recommend that you send in the camera for calibration once a year. Contact your local sales office for instructions on where to send the camera.

3.5 Training

For training resources and courses, go to <https://www.flir.com/support-center/training>.

3.6 Important note about this manual

FLIR Systems issues generic manuals that cover several cameras within a model line.

This means that this manual may contain descriptions and explanations that do not apply to your particular camera model.

3.7 Note about authoritative versions

The authoritative version of this publication is English. In the event of divergences due to translation errors, the English text has precedence. Any late changes are first implemented in English.

3.8 Disposal of electronic waste

Electrical and electronic equipment (EEE) contains materials, components and substances that may be hazardous and present a risk to human health and the environment when waste electrical and electronic equipment (WEEE) is not handled correctly.

Equipment marked with the below crossed-out wheeled bin is electrical and electronic equipment. The crossed-out wheeled bin symbol indicates that waste electrical and electronic equipment should not be discarded together with unseparated household waste, but must be collected separately.

For this purpose all local authorities have established collection schemes under which residents can dispose waste electrical and electronic equipment at a recycling centre or other collection points, or WEEE will be collected directly from households. More detailed information is available from the technical administration of the relevant local authority.



4.1 General

Do not hesitate to contact our Customer Support Center if you experience problems or have any questions.

For customer help, go to <http://support.flir.com>.

4.2 Submitting a question

To submit a question to the customer help team, you must be a registered user. It only takes a few minutes to register online. If you only want to search the knowledgebase for existing questions and answers, you do not need to be a registered user.

When you want to submit a question, make sure that you have the following information to hand:

- The camera model.
- The camera serial number.
- The communication protocol, or method, between the camera and your device (e.g., SD card reader, HDMI, Ethernet, USB, or FireWire).
- Device type (PC/Mac/iPhone/iPad/Android device, etc.).
- Version of any programs from FLIR Systems.
- Full name, publication number, and revision number of the manual.

4.3 Downloads

On the customer help site you can also download the following, when applicable for the product:

- Firmware updates for your infrared camera.
- Program updates for your PC/Mac software.
- Freeware and evaluation versions of PC/Mac software.
- User documentation for current, obsolete, and historical products.
- Mechanical drawings (in *.dxf and *.pdf format).
- CAD data models (in *.stp format).
- Application examples.
- Technical datasheets.

Follow this procedure:

1. Put a battery into the battery compartment.
2. Connect the USB battery charger to the USB connector at the top of the camera.
3. Charge the battery for 2 hours before starting the camera for the first time.
4. Insert a memory card into the card slot at the top of the camera.

Note Empty or use a memory card that has not previously been used in another type of camera. The cameras may organize files differently on the memory card. There is therefore a risk of losing data if the same memory card is used in different types of cameras.

5. Push the on/off button  to turn on the camera.
6. Follow the instructions on the camera screen to configure your camera. You can, for example, select the language, units, and date and time formats.

You can also set up the camera to upload images for storage online. To enable upload of images, you need to connect the camera to a Wi-Fi network and pair the camera with a FLIR Ignite account. Use a computer or other device with internet access and follow the instructions on the camera screen.

Note You can do all the settings as a part of the initial setup of the camera or later at any time via the *Settings* menu.

7. To enable automatic upload of images, select  (*Settings*), sign in to FLIR Ignite, and set the *Auto upload* switch to *On*.
8. Aim the camera toward the object of interest.
9. Adjust the infrared camera focus by rotating the focus ring.

Note It is very important to adjust the focus correctly. Incorrect focus adjustment affects how the image modes work. It also affects the temperature measurement.

10. Pull the trigger to save an image.
11. If automatic upload is enabled, new images will automatically be uploaded to your FLIR Ignite account when the camera is connected to the internet. You can also upload images manually. To access your FLIR Ignite account, go to <https://ignite.flir.com>.

You can also move images from the camera using the USB cable or the memory card.

12. Import the images into a FLIR Thermography software and create an inspection report.

5.1 To keep in mind

- Adjust the focus first. When the camera is out of focus, the measurement will be wrong.
- By default, most cameras adapt the scale automatically. Use this mode first, but do not hesitate to set the scale manually.
- A thermal camera has a resolution limit. This depends on the size of the detector, the lens, and the distance to the target. Use the center of the spot tool as a guide to the minimum possible object size, and get closer if necessary. Make sure to stay away from dangerous areas and live electrical components.
- Be careful when holding the camera perpendicular to the target. Be observant of reflections, especially at low emissivities—you, the camera, or the surroundings may become the main source of reflection.
- Select a zone of high emissivity, e.g., an area with a matte surface, to perform a measurement.
- Blank objects, i.e., those with low emissivities, may appear warm or cold in the camera, because they mainly reflect the environment.
- Avoid direct sunlight on the details that you are inspecting.
- Various types of faults, e.g., those in a building's construction, may result in the same type of thermal pattern.

- Correctly analyzing an infrared image requires professional knowledge about the application.

6.1 View from the front

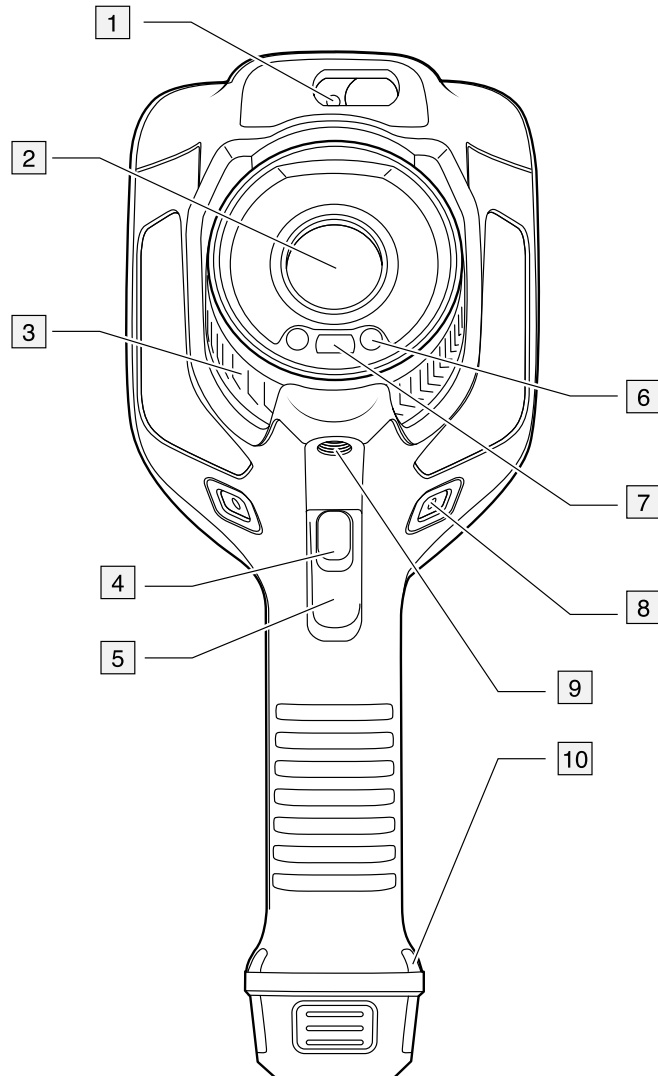

1. Laser distance meter.¹
2. Infrared lens.
3. Focus ring.
4. Autofocus button.¹
5. Trigger.
6. Lamp for the digital camera (left and right sides).
7. Digital camera.
8. Attachment point for the hand strap bracket (left and right sides).
9. Tripod mount.
10. Attachment point for the hand strap, wrist strap, or lanyard strap (left and right sides).

1. This item is dependent on the camera model.

6.2 View from the rear

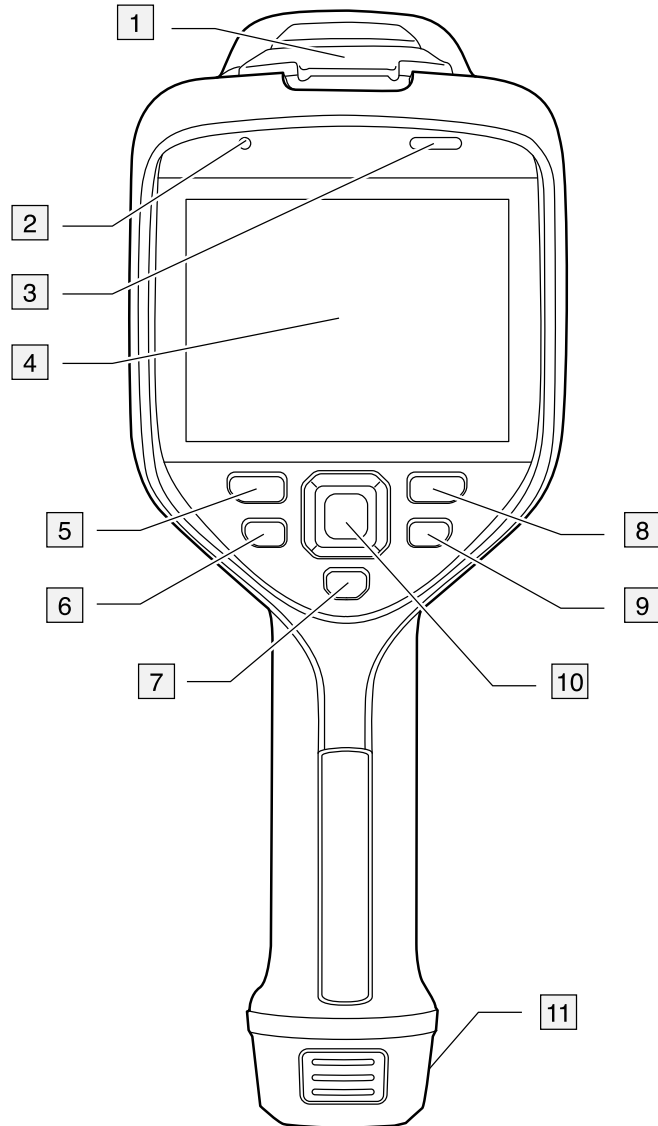

1. Cover for the USB connector and memory card slot.
2. Microphone.
3. Speaker.
4. Touch-screen LCD.
5. Image archive button.
6. Programmable button.
7. Button to operate the laser.
8. Back button.
9. On/off button.
10. Navigation pad with center push.
11. Battery.

6.3 Laser distance meter and laser pointer

The laser distance meter consists of a laser transmitter and a laser receiver. The laser transmitter also works as a laser pointer.

6.3.1 Laser transmitter and receiver

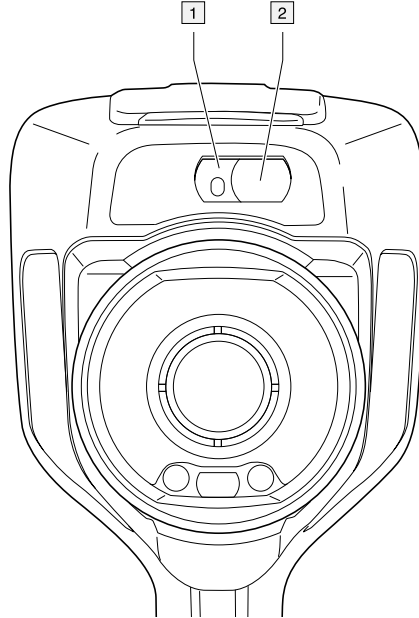

1. Laser transmitter.
2. Laser receiver.²

6.3.2 Difference in position

This figure shows the difference in position between the laser transmitter and the optical center of the infrared lens.

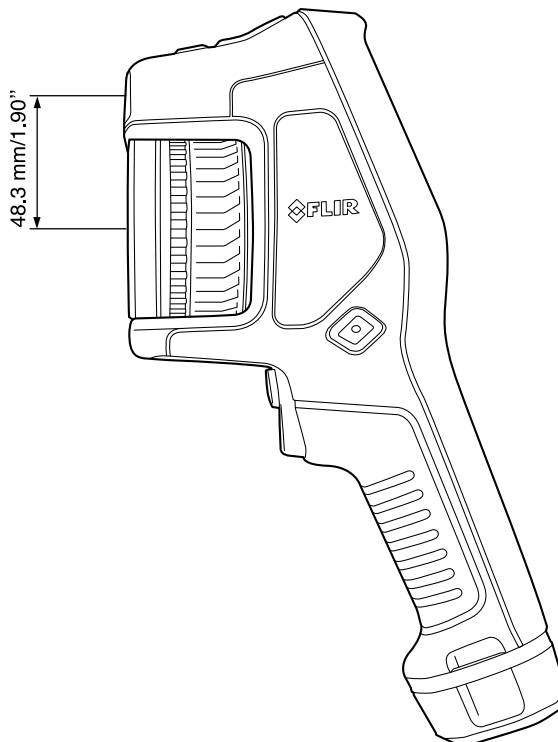

². This item is dependent on the camera model.

6.3.3 Laser warning label

A laser warning label with the following information is attached to the camera:



6.3.4 Laser rules and regulations

Wavelength: 650 nm. Maximum output power: 1 mW.

This product complies with 21 CFR 1040.10 and 1040.11 except for deviations pursuant to Laser Notice No. 50, dated June 24, 2007.

6.4 Screen elements

6.4.1 General

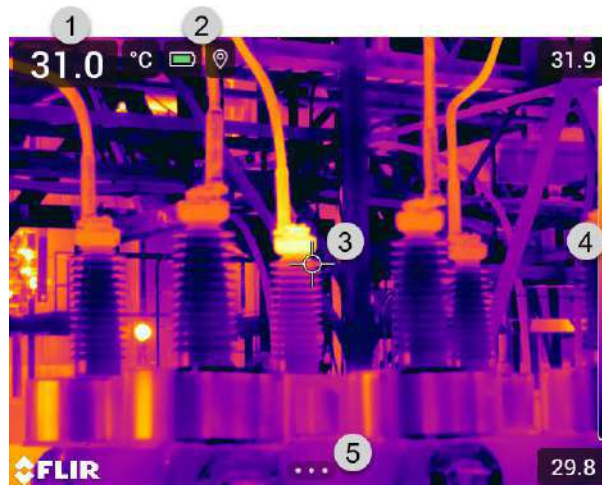

1. Result table.
2. Status icons.
3. Measurement tool (e.g., spotmeter).
4. Temperature scale.
5. Menu system button.

6.4.2 Menu system





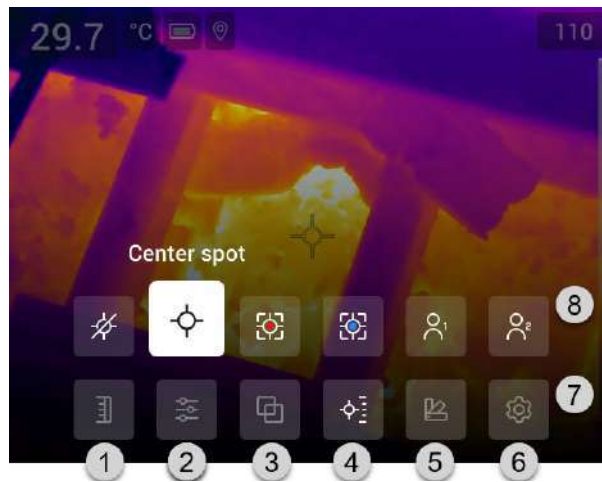



To display the menu system, push the navigation pad or tap the menu system button





1. Temperature scale button.
2. Measurement parameters button.
3. Image mode button.
4. Measurement button.
5. Color button.
6. Settings button.
7. Main menu.³
8. Submenu.

6.4.3 Status icons and indicators

	Battery level <ul style="list-style-type: none"> • Green: above 75% • Yellow: up to 75% • Red: up to 25% • No color: below 15%
	The remaining storage capacity of the memory card is below 100 MB.
	The GPS is enabled. If the icon is grey, the camera cannot find a GPS signal.
	External infrared window compensation is enabled.
	The camera is paired with a FLIR Ignite account.
	The camera is paired, but does not have contact with FLIR Ignite (no internet connection).
	A Bluetooth headset is connected.
	The laser is on.

6.4.4 Swipe-down menu

To open the swipe-down menu, place your finger at the top of the screen and swipe down.

³. This item is dependent on the camera model.

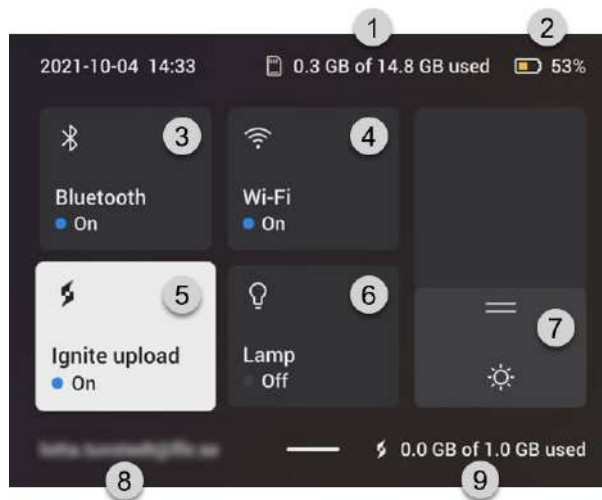

1. Storage status of the memory card.
2. Battery status indicator.
3. *Bluetooth* button: Touch to enable/disable Bluetooth. Touch and hold to open the Bluetooth settings menu. See also section 21 *Pairing Bluetooth devices*.
4. *Wi-Fi* button: Touch to enable/disable Wi-Fi. Touch and hold to open the Wi-Fi settings menu. See also section 20 *Configuring Wi-Fi*.
5. *Ignite upload* button: Touch to enable/disable automatic upload of images and videos. See also section 9.5 *Automatic upload*.

Note If the camera is not paired with a FLIR Ignite account, you will be prompted to sign in to FLIR Ignite before you can enable automatic upload.

6. *Lamp* button: Touch to turn on/off the camera lamp.

Note

- Before you can turn on the camera lamp, you need to enable the lamp. Select  (*Settings*) > *Device settings* > *Lamp & laser* > *Enable lamp & laser* or *Enable lamp & laser + Use lamp as flash*.
- The availability of the camera lamp depends on the lens model.

7. Screen brightness slider: Use to control the brightness of the screen.
8. The FLIR Ignite user account that the camera is paired with. For more information, see section 9.4 *Pairing with FLIR Ignite*.
9. Storage status of the FLIR Ignite account.

6.4.5 Image overlay information

The image information consists of items such as the date, emissivity, and atmospheric temperature. All image information is saved in the image file and can be viewed in the image archive. You can also choose to display selected items as image overlay information. All image overlay information displayed on the live image will also be displayed on saved images. For more information, see sections section 23.6 *Device settings* and 11.8 *Hiding all overlay*.



6.5 Navigating the menu system

You can navigate the menu system in two ways:

- Using your finger or a stylus pen specially designed for capacitive touch usage.
- Using the navigation pad and the back button .

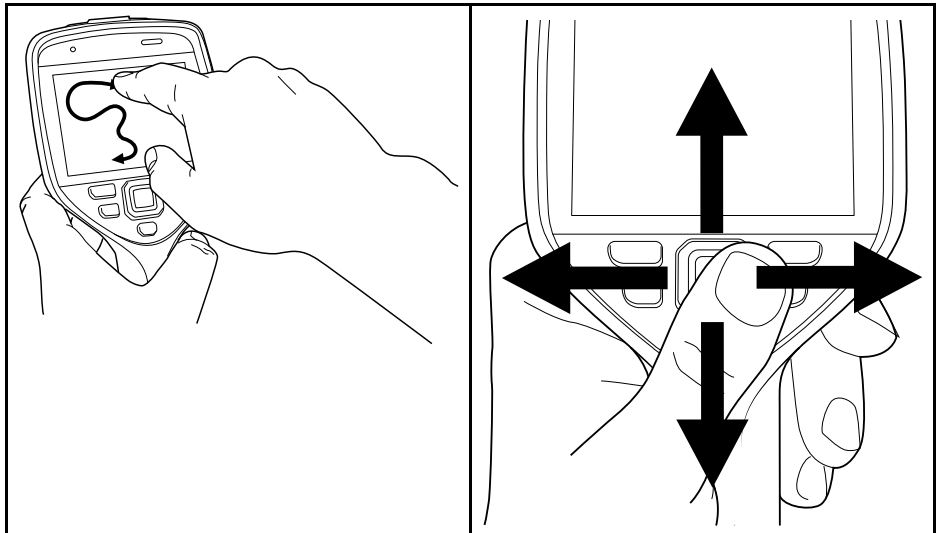

6.5.1 Navigating using the navigation pad

You navigate the menu system by using the navigation pad and the back button:

- To display the menu system, push the center of the navigation pad.
- To navigate in menus, submenus, and dialog boxes, and to change values in dialog boxes, push the navigation pad up/down or left/right.
- To confirm changes and settings in menus and dialog boxes, push the center of the navigation pad.
- To leave dialog boxes and to go back in the menu system, push the back button .

7.1 Charging the battery

7.1.1 General

- Before starting the camera for the first time, charge the battery for 2 hours using the stand-alone battery charger.
- Select a mains socket that is near the equipment and easily accessible.

7.1.2 Using the stand-alone battery charger to charge the battery

1. Put one or two batteries in the battery charger.
2. Connect the power supply cable plug to the connector on the battery charger.
3. Connect the power supply mains-electricity plug to a mains socket.
4. When the white LED on the battery charger glows continuously, the batteries are fully charged.
5. It is good practice to disconnect the stand-alone battery charger from the mains socket when the batteries are fully charged.

7.1.2.1 Stand-alone battery charger LED indicator

Type of signal	Explanation
The white LED flashes.	The battery is being charged.
The white LED glows continuously.	The battery is fully charged.

7.1.3 Using the USB battery charger to charge the battery

1. Put the battery into the battery compartment of the camera.
2. Connect the USB battery charger to a mains socket.
3. Fold up the rubber cover at the top of the camera.

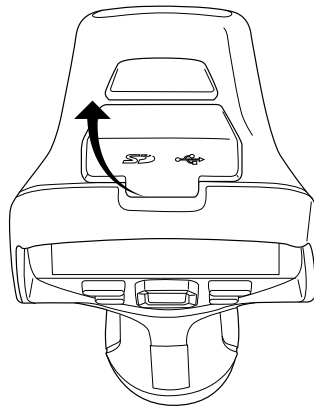

4. Connect the USB connector of the USB battery charger to the USB-C connector in the connector bay of the camera.

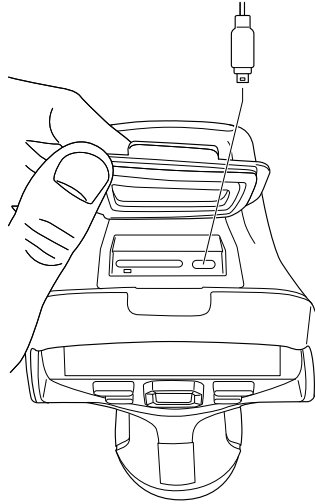

5. To check the status of the battery charging, do one of the following:
 - If the camera is turned on: Place your finger at the top of the screen and swipe down. The battery status is displayed on the swipe-down menu.
 - If the camera is turned off: The battery charging indicator is displayed on the screen.
6. It is good practice to disconnect the USB battery charger from the mains socket when the battery is fully charged.

7.1.4 Charging the battery using a USB cable connected to a computer

1. Fold up the rubber cover at the top of the camera.

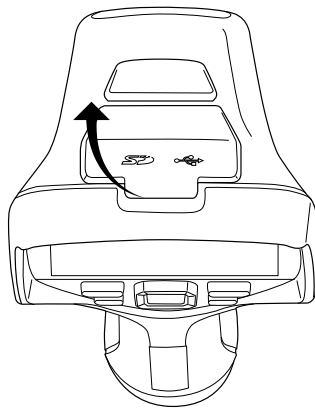

-
2. Connect a USB cable to the USB-C connector in the connector bay. Connect the other end of the USB cable to the computer.

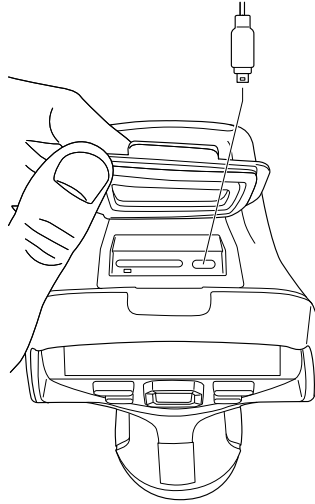
**Note**



- To charge the camera, the computer must be turned on.
- Charging the camera using a USB cable connected to a computer takes *considerably* longer than using the USB battery charger or the stand-alone battery charger.

7.2 Removing the battery

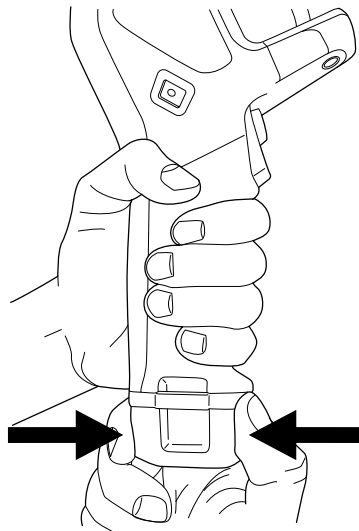
1. Turn off the camera.
2. Remove the battery from the camera.



7.3 Turning on and turning off the camera

- To turn on the camera, push the on/off button .
- To turn off the camera, push and hold the on/off button  for more than 0.5 second.

Note Do not remove the battery to turn off the camera.

7.4 Adjusting the thermal camera focus

It is very important to adjust the focus correctly. Incorrect focus adjustment affects how the image modes work. It also affects the temperature measurement.

You can adjust the camera focus by rotating the focus ring or by pushing the autofocus button. The camera can also be set up to perform continuous autofocusing.

7.4.1 Manual focus

To adjust the focus manually, rotate the focus ring.

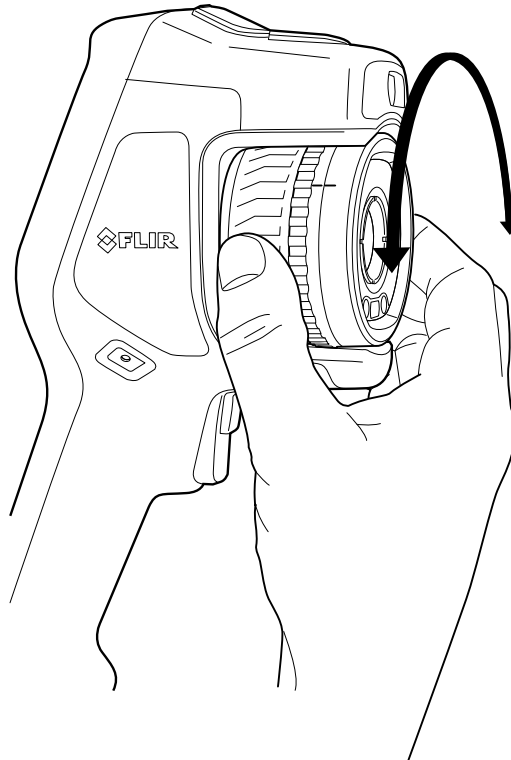

Note Do not touch the lens surface when you adjust the focus. If this happens, clean the lens according to the instructions in 24.2 *Infrared lens*.

7.4.2 Autofocus

To autofocus the camera, push the Autofocus button.

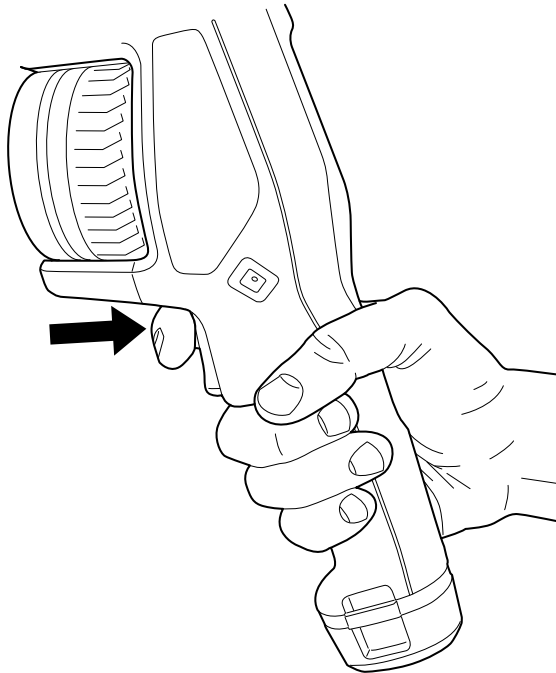
**Note**

- You can also assign the autofocus function to the programmable button. For more information, see section 7.9 *Programmable button*.
- Autofocus is not supported by all camera models.

7.4.2.1 Autofocus method

When autofocusing, the camera can use one of the following focus methods:

- *Contrast*: The focus is based on maximizing the image contrast.
- *Laser*: The focus is based on a laser distance measurement. The laser is used when the camera is autofocusing.

The focus method is configured by a setting. Select  (*Settings*) > *Device settings* > *Focus* > *Auto focus* and then select *Contrast* or *Laser*.

**WARNING**

When the camera is set to autofocusing with the laser method, do not point the camera at the face of a person when you use the autofocus function. The laser beam can cause eye irritation.

7.4.3 Continuous autofocus

The camera can be set up to perform continuous autofocusing.

When the continuous autofocus function is enabled, the camera bases the focus adjustments on continuous laser distance measurements. The laser is continuously on.

To enable or disable continuous autofocus, select  (*Settings*) > *Device settings* > *Focus* > *Continuous autofocus* > *On* or *Off*.

**WARNING**

Do not point the camera at the face of a person when the continuous autofocus function is on. The camera uses laser distance measurements (that are continuous) for the focus adjustments. The laser beam can cause eye irritation.

Note

- Before you can enable continuous autofocus, you need to enable the laser and select laser as focus method. See section 7.4.2.1 *Autofocus method*.
- When continuous autofocus is enabled, it is not possible to manually adjust the focus by rotating the focus ring.
- You can also assign the continuous autofocus function to the programmable button. For more information, see section 7.9 *Programmable button*.
- Continuous autofocus is not supported by all camera models.

7.5 Operating the laser distance meter



7.5.1 General

The laser distance meter consists of a laser transmitter and a laser receiver. The laser distance meter determines the distance to a target by measuring the time it takes for a laser pulse to reach the target and return to the laser receiver. This time is converted to a distance, which is displayed on the screen.

The laser transmitter also works as a laser pointer. When the laser is on, you will see a laser dot approximately at the target.



	WARNING
Do not look directly into the laser beam. The laser beam can cause eye irritation.	

Note

- The laser is enabled by a setting. Select  (*Settings*) > *Device settings* > *Lamp & laser* > *Enable lamp & laser*.
- The symbol  is displayed on the screen when the laser is on.
- The camera can be configured to automatically measure the distance when an image is saved. Select  (*Settings*) > *Save options & storage* > *Measure distance*. With this setting, the *Object distance* parameter (see section 13.5 *Changing the measurement parameters*) in the image data is automatically updated with the measured distance when an image is saved. (There is no effect on the *Object distance* setting in live mode.)
- If the target reflection is low or if the target is angled from the laser beam, there may be no return signal, and the distance cannot be measured.
- The laser distance meter is not supported by all camera models.
- The laser distance meter may not be enabled in all markets.

7.5.2 Procedure

To operate the laser, do the following:

1. To turn on the laser, push and hold the laser button . The distance to the target is displayed on the screen.
2. To turn off the laser, release the laser button .

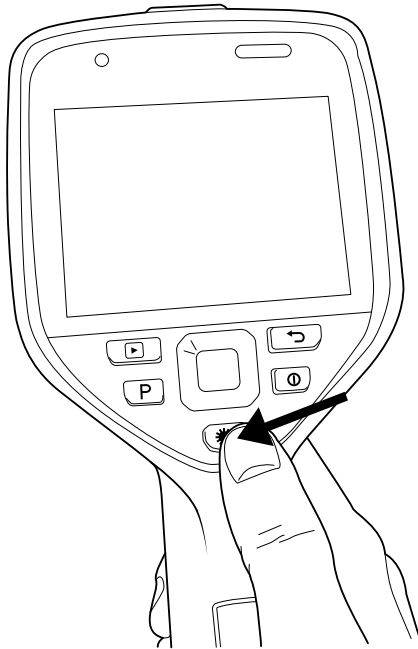

7.6 Measuring areas

7.6.1 General

Note The availability of this feature is dependent on the camera model.

The distance measured by the laser distance meter can be used as the basis for area calculations. A typical application is to estimate the size of a damp stain on a wall.

To measure the area of a surface, you need to lay out a box or circle measurement tool on the screen. The camera calculates the area of the surface enclosed by the box or circle tool. The calculation is an estimate of the surface area, based on the measured distance to the target.

When the laser distance meter is on, you will see a laser dot approximately at the target. The laser distance meter measures the distance to that target. The camera assumes that this distance is valid for the entire box or circle tool.

For successful area measurements, keep the following in mind:

- Make sure that the box or circle tool is in the center of the image.
- Adjust the size of the box or circle tool to the size of the target.
- Hold the camera perpendicular to the target.
- Avoid targets with many details at different distances from the camera.

7.6.2 Procedure

Note This procedure assumes that you have enabled the laser. Select  (Settings) > Device settings > Lamp & laser > Enable lamp & laser.

Follow this procedure:

1. Add a box or circle measurement tool, see section 13.2 *Adding/removing measurement tools*.
2. Set the camera to measure and display the area of the box or circle, see section 13.6 *Displaying values in the result table*.
3. Make sure that the box or circle tool is in the center of the image, see section 13.4 *Moving and resizing a measurement tool*.
4. Adjust the size of the box or circle tool to the size of the target, see section 13.4 *Moving and resizing a measurement tool*.

5. Hold the camera perpendicular to the target. Push and hold the laser button .
6. The calculated area is displayed in the result table.

7.7 Connecting external devices and storage media

You can connect the following external devices and media to the camera:

- An SD memory card.
- A computer to move image and video files to and from the camera, using a USB-C to USB-A or a USB-C to USB-C cable.
- A video monitor or projector, using a USB-C to HDMI adapter.
- A USB battery charger.

Note Empty or use a memory card that has not previously been used in another type of camera. The cameras may organize files differently on the memory card. There is therefore a risk of losing data if the same memory card is used in different types of cameras.

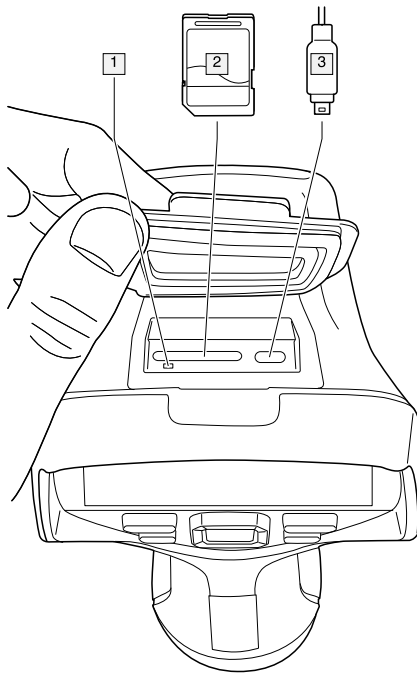

1. LED indicator showing that the memory card is busy.

Note

- Do not eject the memory card when this LED is flashing.
- Do not connect the camera to a computer when this LED is flashing.

2. SD memory card.
3. USB-C cable.

7.8 Moving files to a computer

When you save an image or video clip in the image archive of the camera, the file is stored on the memory card.

You can connect the camera to a computer, using a USB-C to USB-A or a USB-C to USB-C cable. Once connected, you can move the image and video files from the memory card to the computer.

To move files to a computer via USB cable, do the following:

1. Fold up the rubber cover at the top of the camera.

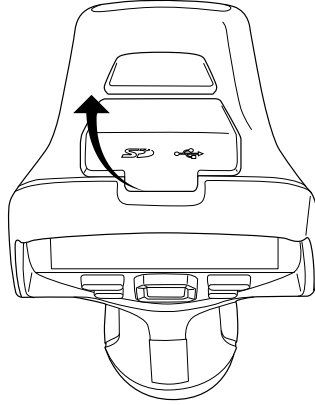

2. Connect a USB cable to the USB-C connector in the connector bay. Connect the other end of the USB cable to the computer.

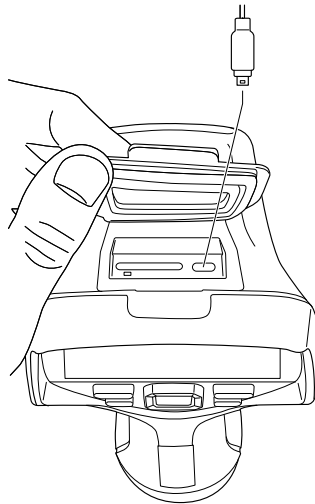

3. Turn on the camera.
4. Do one of the following:
 - Move the files to the computer using a drag-and-drop operation.
Note Moving a file using a drag-and-drop operation does not delete the file in the camera.
 - Import the images into a FLIR Thermography software.

7.8.1 Related topics

You can also set up the camera to upload images for storage online, see section 9 *Cloud connectivity*, page 46.

7.9 Programmable button

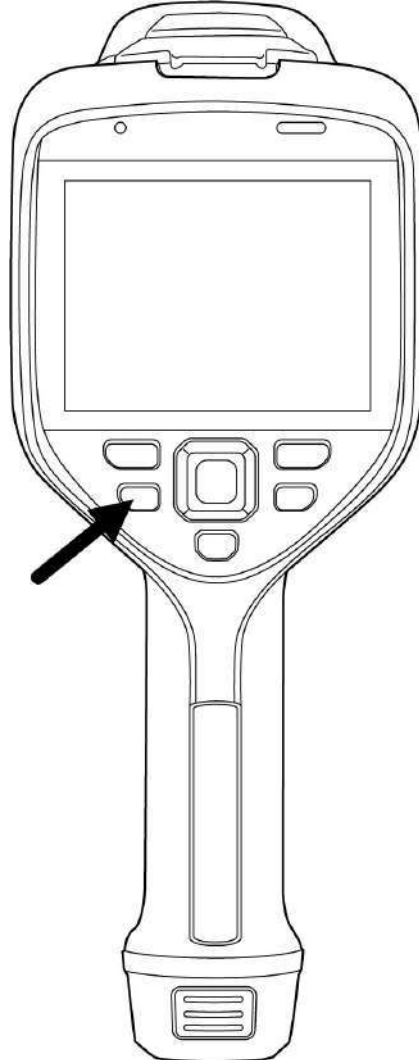

You can assign different functions to the programmable button. You can, for example, use the programmable button to easily switch between two settings you use often. You can also choose to define two different setups for saving and previewing: the ordinary setup for the trigger (which is defined by the *Save options and storage* settings, see section 23.5 *Save options & storage*) and another setup for the programmable button.

To assign a function to the programmable button, do the following:

1. Push and hold the programmable button. This displays the *Programmable button* menu.
2. Push the navigation pad up/down to select one of the functions. Push the center of the navigation pad to confirm.

7.9.1 Programmable button options

Available options for the programmable buttons:

- *No action*: This is the default setting. Nothing will happen when you push the button.

-
- *Switch Auto <> Manual temperature scale*: Switch between automatic or manual image adjustment mode. For more information, see section 11.3 *Adjusting the infrared image*.
 - *Autofocus⁴*: One-shot autofocus of the infrared camera.
 - *Continuous autofocus⁴*: Switch between the enabled/disabled continuous autofocus functions.
 - *Hide image overlay graphics*: Switch between hide/show all overlay graphics and image overlay information. For more information, see section 11.8 *Hiding all overlay*.
 - *Calibrate*: Perform a manual NUC. For more information, see section 11.7 *Performing a non-uniformity correction (NUC)*.
 - *Auto-adjust the manual temperature scale*: Perform an automatic adjustment of the image while remaining in manual image adjustment mode.
 - *Switch Thermal <> Digital camera*: Switch between the image modes *Thermal* and *Digital camera*. For more information, see section 12 *Working with image modes*.
 - *Switch Thermal <> Thermal MSX⁵*: Switch between the image modes *Thermal* and *Thermal MSX*. For more information, see section 12 *Working with image modes*.
 - *Switch 1x zoom <> Max zoom*: Switch between the digital zoom factor of 1x and maximum zoom.
 - *Switch camera flash On <> Off⁶*: Switch between the enabled/disabled camera flash functions. For more information, see section 7.10 *Using the camera lamp as a flash*.

Note The flash function will not be activated if the setting *Lamp & laser* is set to the option *Disable all*. For more information, see section 23.6 *Device settings*.

- *Switch single shot <> Video*: Switch between the recording modes *Single shot* and *Video*.
- *Switch between two latest palettes*: Switch between the two last-used color palettes. For more information, see section 11.5 *Changing the color palettes*.
- *Switch temperature range*: Cycle through the camera temperature ranges. For more information, see section 23.4 *Camera temperature range*.
- *Switch screen rotation On <> Off*: Switch between enabled/disabled screen rotation.
- *Save*: Save an image.
- *Save + Prompt for note*: Save an image and display the note annotation tool.
- *Save + Prompt for table*: Save an image and display the table annotation tool.
- *Save + Prompt for voice annotation*: Save an image and display the voice annotation tool.
- *Save + Prompt for sketch*: Save an image and display the sketch annotation tool.
- *Save + Select annotation from menu*: Save an image and display the annotation tool menu.
- *Preview*: Display a preview image.
- *Preview + Prompt for note*: Display a preview image and the note annotation tool.
- *Preview + Prompt for table*: Display a preview image and the table annotation tool.
- *Preview + Prompt for voice annotation*: Display a preview image and the voice annotation tool.
- *Preview + Prompt for sketch*: Display a preview image and the sketch annotation tool.
- *Preview + Select annotation from menu*: Display a preview image and the annotation tool menu.

7.10 Using the camera lamp as a flash

The camera lamp can be used as a flash for the digital camera. When the flash function is enabled, the camera lamp will flash when an image is saved by pulling the trigger.

Note The availability of this feature is dependent on the lens model.

You can also turn on the camera lamp to use it as a flashlight.

4. This item is dependent on the camera model.

5. This item is dependent on the lens model.

Follow this procedure:

1. Push the navigation pad to display the menu system.
2. Select  (*Settings*) and push the navigation pad. This displays the *Settings* menu.
3. Use the navigation pad to select *Device settings* > *Lamp & laser*.
4. To use the camera lamp as a flash, do one of the following:
 - To enable the camera lamp function, select *Enable lamp & laser* and push the navigation pad. To turn on/off the camera lamp, use the swipe-down menu, see section 6.4.4 *Swipe-down menu*.
 - To enable the flash function, select *Enable lamp & laser + Use lamp as flash* and push the navigation pad.
 - To disable the camera lamp and flash functions, select *Disable all* and push the navigation pad.

Note You can also assign the function *Switch camera flash On <> Off* to the programmable button. For more information, see section 7.9 *Programmable button*.

7.11 Hand strap

The upper part of the hand strap is attached to the camera by a bracket. There is one bracket for the left side and one for the right side of the camera.

The lower part of the hand strap is threaded through the attachment point at the base of the camera.

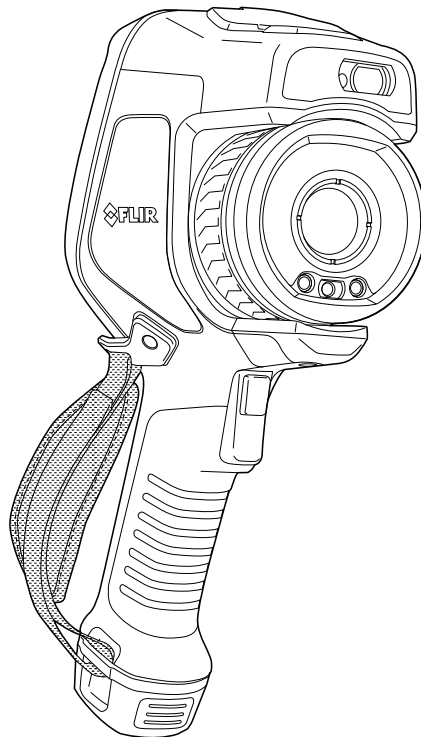

7.11.1 Mounting the hand strap

1. Fit the upper part of the hand strap into the bracket.

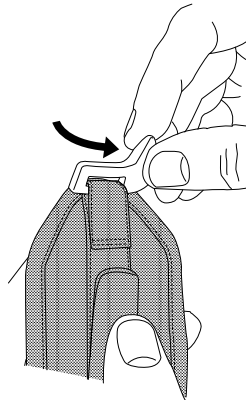
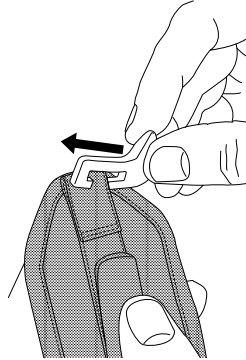

2. Fit the bracket in place on the camera and tighten the screw with the supplied Torx key.

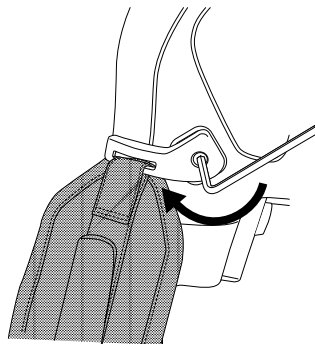

-
3. Thread the loose strap through the attachment point at the base of the camera. Secure the strap with the hook-and-loop fastener.

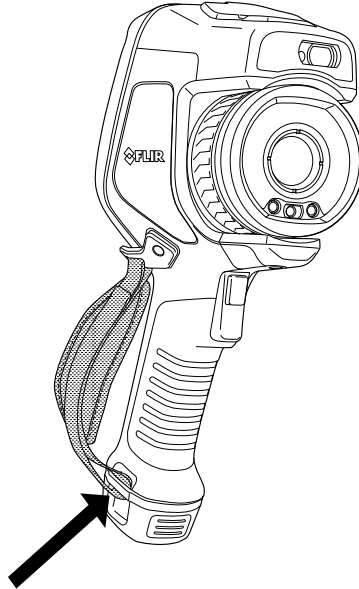

7.12 Lanyard strap

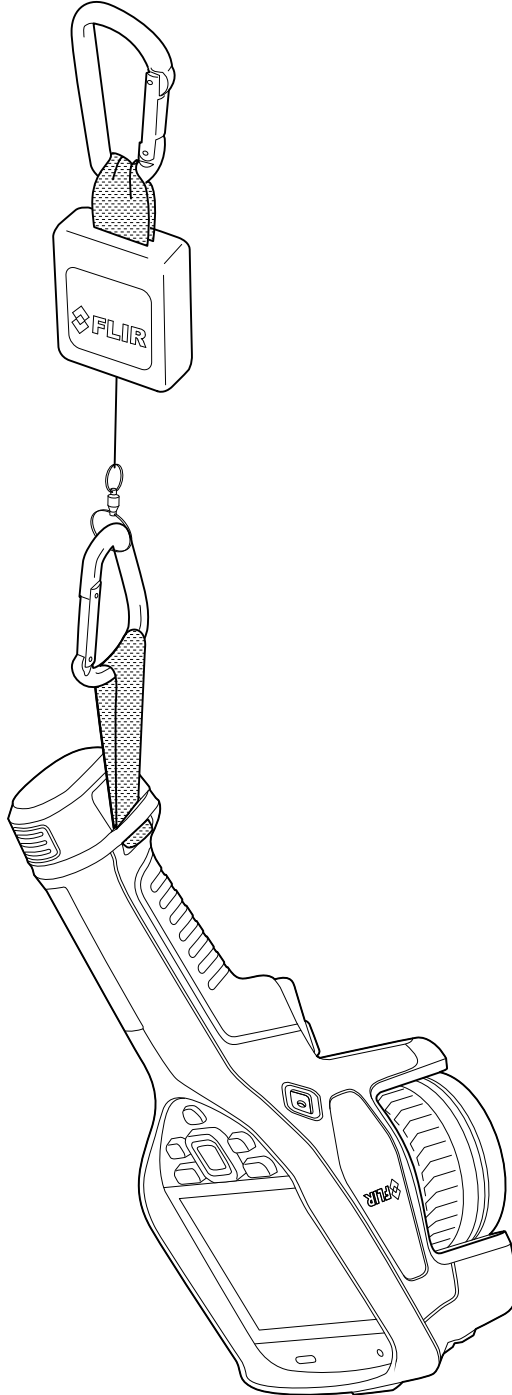

To mount the lanyard strap, do the following:

1. Remove the camera battery.

2. Starting with the FLIR logo part, thread the lanyard strap through the attachment point at the base of the camera.

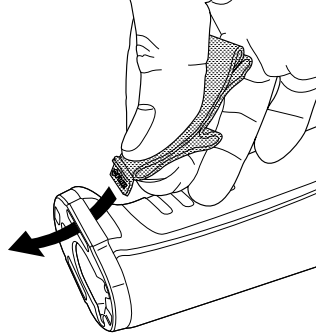

3. Pull the entire lanyard strap through the attachment point until it stops.

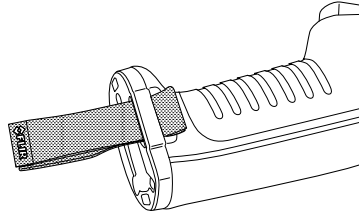

7.13 Wrist strap

The wrist strap can also be used to attach a carabiner to the camera.

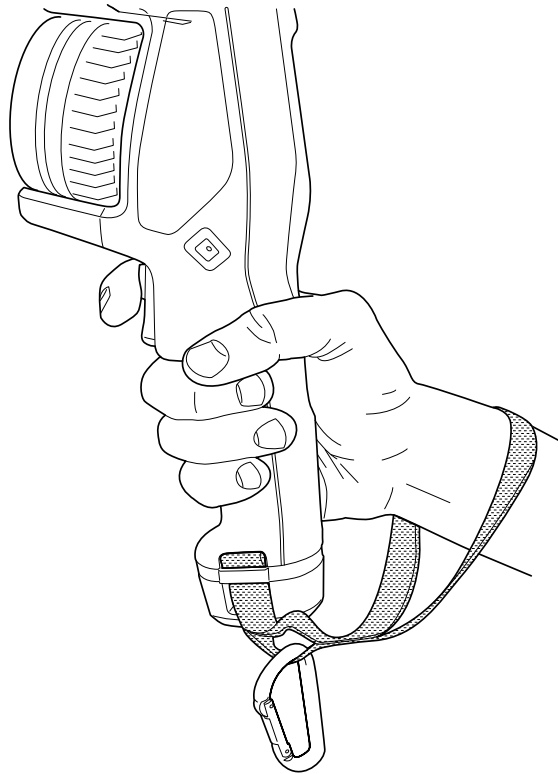

To mount the wrist strap, do the following:

1. Remove the camera battery.

2. Fold the wrist strap. Make sure that the part with the FLIR logo faces away from the bend.

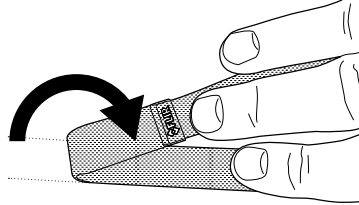

3. Thread the bent wrist strap through the attachment point at the base of the camera.

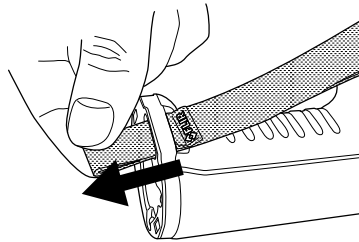

4. Pull the entire wrist strap through the attachment point until it stops.

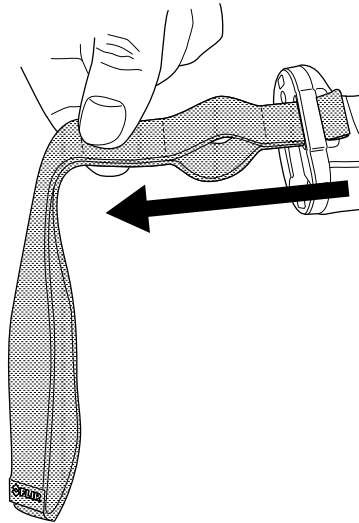

7.14 Front protection

To protect the camera lens and the laser distance meter, you can attach the front protection by using the supplied fastening device.

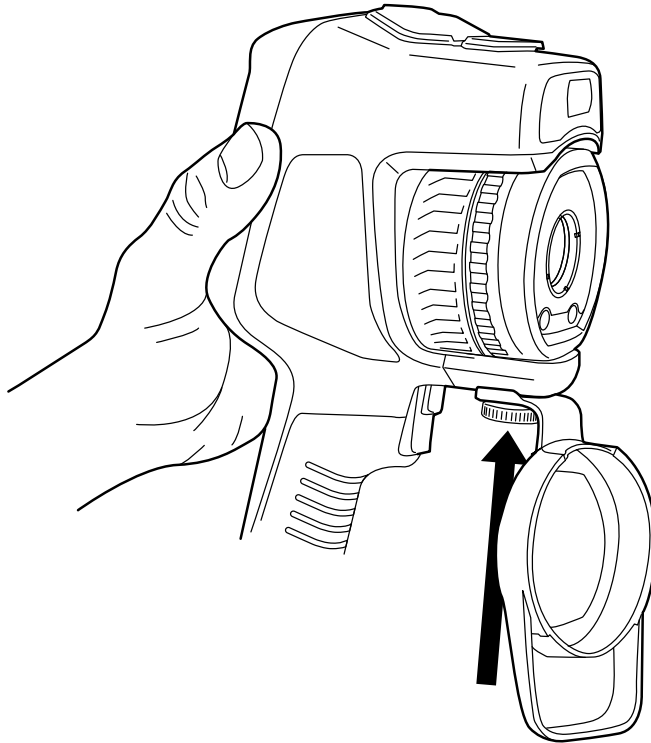

7.15 Changing camera lenses

Applicability: Camera models with an exchangeable lens.

Note If the new lens has not been used with the camera before, the lens-camera combination must be calibrated after the lens has been mounted. See section 7.16 *Calibrating the lens-camera combination* for information on how to do this.

Note Do not touch the lens surface when you change lenses. If this happens, clean the lens according to the instructions in 24.2 *Infrared lens*.

Follow this procedure:

1. Take a firm grip around the inner ring of the lens. Rotate the inner ring 30° counter-clockwise until it stops.

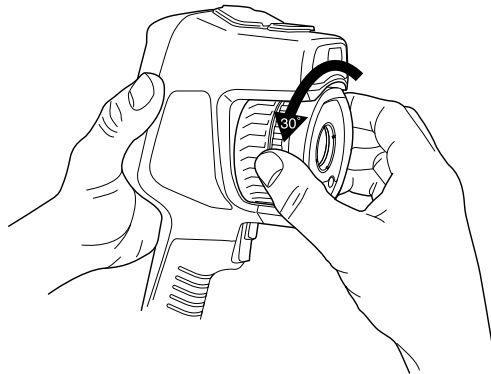

-
2. Carefully pull out the lens.

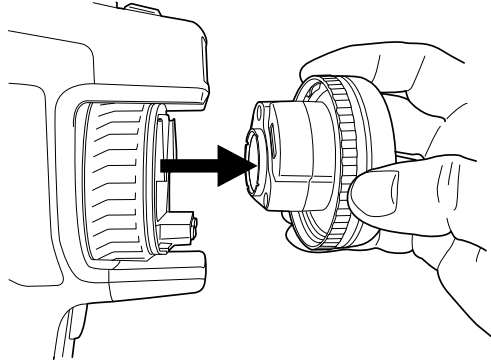

3. The infrared detector is now fully exposed. Do not touch this surface. If you see dust on the detector, follow the instructions in 24.3 *Infrared detector*.

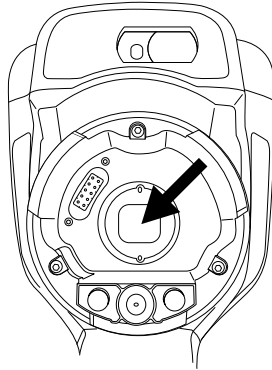

4. Make sure that the inner ring of the camera lens is fully in its open position.

- Correct: The tooth (1) is in its end position at the black stop pin (2).

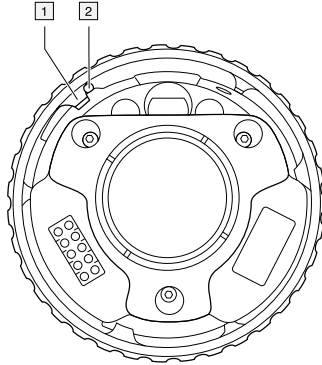

- Wrong: You must rotate the inner ring until the tooth (1) reaches the black stop pin (2).

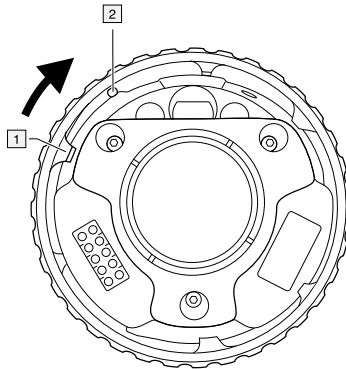

5. Carefully push the lens into position.

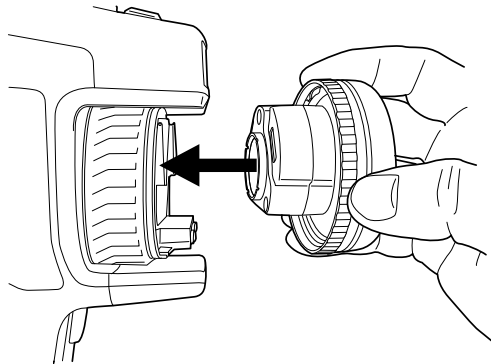

-
6. Rotate the inner ring of the lens 30° clockwise. The lens makes a click when it locks in place.

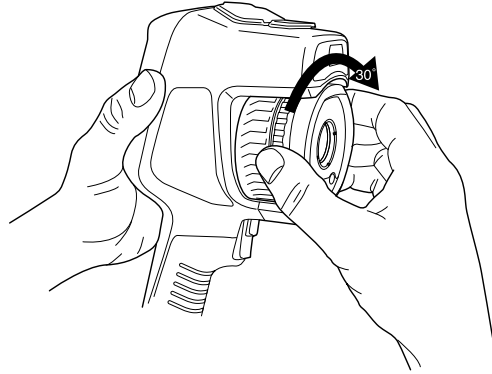

7. Make sure that the two index marks are aligned, indicating that the lens is locked in place.

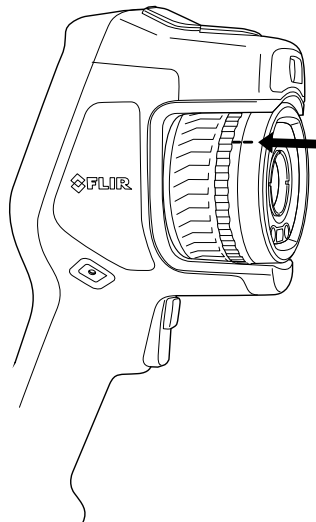

7.16 Calibrating the lens–camera combination

Applicability: Camera models with an exchangeable lens.

7.16.1 Introduction

Before a new lens can be used with the camera, the lens–camera combination must be *calibrated*.

For lens models with the AutoCal feature, the calibration can be performed by the user. The AutoCal procedure requires a calibration target, which is included in the lens package.

For other lens models, the calibration must be performed by a FLIR service department.

Note For lenses that ship with the camera, the lens–camera combination is factory calibrated.

7.16.2 AutoCal procedure

1. Dip the calibration target in water for 1 second and let the excess drip off.

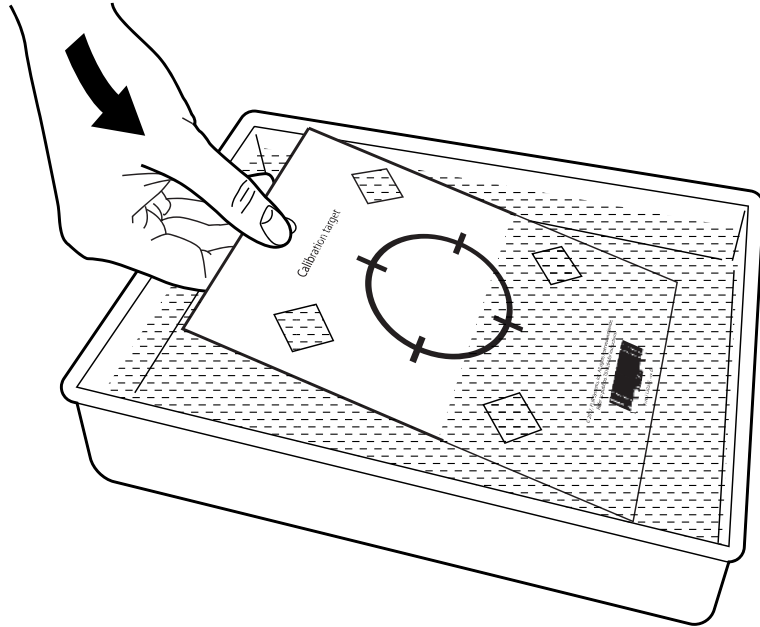

2. Tape or hang the calibration target on a wall.

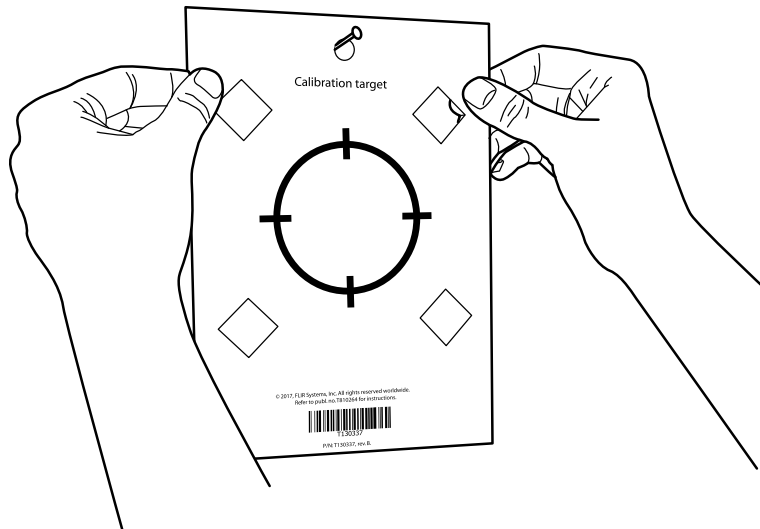

3. Mount the new lens on the camera according to the procedure in section 7.15 *Changing camera lenses*. When the lens is mounted, the calibration wizard starts automatically.

4. From a distance of 2 m (6.6 ft.), aim the camera toward the crosshair, using the laser pointer. The camera will take a picture automatically.

Note Make sure the camera's optical path is perpendicular to the calibration target. See the image below.

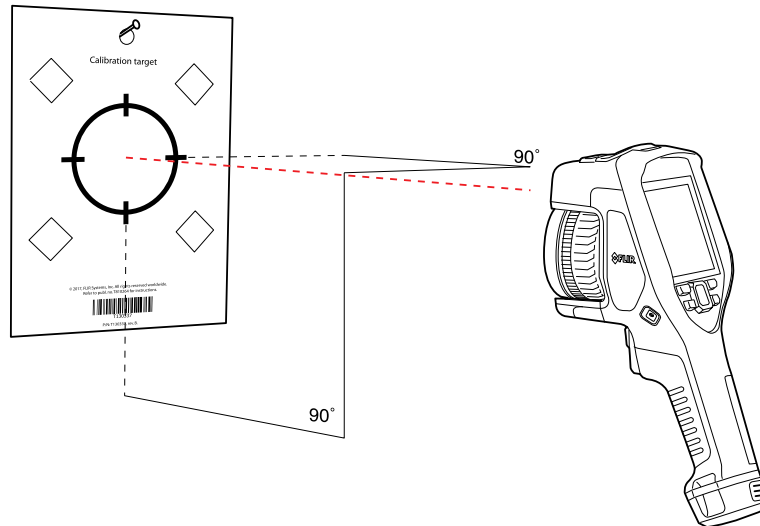

5. In the camera, align the thermal and visual images (indicated by the two squares in the image below), using the touchscreen arrows. The lens-camera combination is now calibrated.

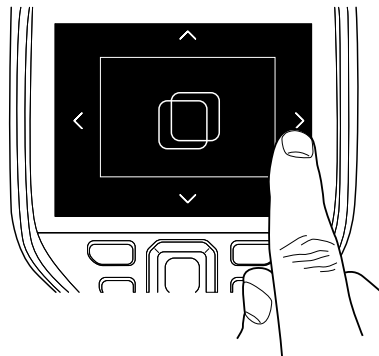

To repeat the procedure at a later time, go to *Settings > Device settings > Camera information > Calibration > Calibrate lens...*

7.17 Calibrating the compass

It is recommended that the compass is calibrated every time you move the camera to a new location.

Follow this procedure:

1. Push the navigation pad to display the menu system.
2. Select  (*Settings*) and push the navigation pad. This displays the *Settings* menu.
3. Use the navigation pad to select *Device settings > Geolocation > Compass*.
4. Make sure the compass is enabled by toggling the switch.
5. Select *Calibrate compass* and push the navigation pad. Follow the on-screen instructions.

Note You must rotate the camera slowly.



8.1 About image files

8.1.1 General

When you save an image, the camera saves an image file that includes all thermal and visual information. This means that you can open an image file at a later time and, for example, select another image mode, apply color alarms, and add measurement tools.

The image *.jpg file is fully radiometric and saved lossless, which enables full post-processing in image analysis and reporting software from FLIR Systems. There is also a regular *.jpg component (lossy) for convenient viewing in non-FLIR Systems software (e.g., Microsoft Explorer).

Note

- The camera can also be configured to save an extra low-resolution visual image as a separate file. This can be convenient if you are not using a post-processing software.
Select  (*Settings*) > *Save options & storage* > *Photo as separate JPEG = On*.
- When the *Digital camera* image mode is selected, a high-resolution digital image is stored when an image is saved. However, no thermal information is stored. For more information, see section 12 *Working with image modes*.
- You can choose to turn off the digital camera. This can, for example, be required in restricted areas and in confidential (e.g., doctor/patient) situations. Select  (*Settings*) > *Save options & storage* > *Digital camera = Off*. When the digital camera is off, features that require visual information, such as the image modes *Thermal MSX* and *Picture in picture*, are disabled.
- The availability of the digital camera depends on the lens model.

8.1.2 File-naming convention

The default naming convention for image files is FLIRxxxx.jpg, where xxxx is a unique counter.

It is also possible to save images with a date prefix added to the filename. However, these files may not automatically be detected by third-party applications. For more information, see the setting *File naming format* in section 23.5 *Save options & storage*.

8.1.3 Storage capacity

When you save an image, the camera stores the image file on the memory card.

The size of an image file (with no annotations) is typically less than 1000 kB. Thus, the capacity of a 8 GB memory card is approximately 8000 images.

Note Empty or use a memory card that has not previously been used in another type of camera. The cameras may organize files differently on the memory card. There is therefore a risk of losing data if the same memory card is used in different types of cameras.

8.1.4 About UltraMax

Note The availability of this feature is dependent on the camera model.

UltraMax is an image enhancement feature that increases the image resolution and lowers the noise, making small objects easier to see and measure. An UltraMax image is twice as wide and high as an ordinary image.

When an UltraMax image is captured by the camera, several ordinary images are saved within the same file. Capturing all the images can take up to 1 second. To fully utilize UltraMax, the images need to be slightly different, which can be accomplished by a minute movement of the camera. You should hold the camera firmly in your hands (do not put it on a tripod), which will make these images vary just a little during the capture. Correct

focus, a high-contrast scene, and a non-moving target are other conditions that help to achieve a good-quality UltraMax image.

Some FLIR Thermography software has the ability to process UltraMax images. Other FLIR software will treat the image as a regular image.

To configure the camera for UltraMax, select  (*Settings*) > *Save options & storage* > *Image resolution = UltraMax*.

8.2 Saving an image

When you save an image, the camera stores the image file in the camera memory.

Note You can also set up the camera to upload images for storage online, see section 9 *Cloud connectivity*.

To save an image, pull the trigger.

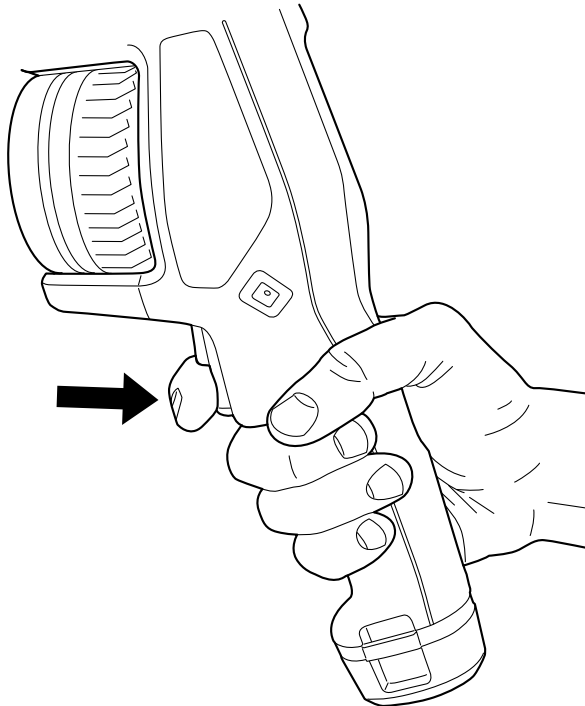

Note Depending on the settings in  (*Settings*) > *Save options & storage*, the following may also happen:

- A preview image is displayed before the image is saved.
- An annotation tool or the annotation menu is displayed when the image has been saved.

8.3 Previewing an image

You can preview an image before you save it. This enables you to see if the image contains the information you want before you save it. You can also adjust and edit the image.

Note The camera must be configured to display a preview image before saving. Select  (*Settings*) > *Save options & storage* > *Preview image before saving = On*.

To preview an image, do the following:





1. To preview an image, pull the trigger. This displays the preview.

-
2. Manual image adjustment mode is now active. For image adjustment instructions, see section 11.3 *Adjusting the infrared image*.
 3. To edit the image, push the navigation pad. This displays a context menu. For editing instructions, see section 8.5 *Editing a saved image*.
 4. Do one of the following:
 - To save the image, pull the trigger.
 - To exit preview mode without saving, push the back button .

8.4 Opening a saved image

When you save an image, the image file is stored on the memory card. To display the image again, open it from the image archive (*Gallery*).



To open a saved image, do the following:

1. Push the image archive button . This displays the *Gallery* with one or more folders.
2. Select a folder and push the navigation pad.
3. Select the image you want to view and push the navigation pad.
4. Do one or more of the following:
 - To view the previous/next image, push the navigation pad left/right.
 - To display a toolbar at the top of the screen, push the navigation pad. Do one or more of the following:
 - To switch between an infrared image and a visual image, select the  icon and push the navigation pad.
 - To edit the image, delete the image, display information, or add annotations, select the  icon and push the navigation pad. This displays a menu to the right.
 - To return to the folder overview, push the back button .
 - To return to the live image, push the image archive button .







8.5 Editing a saved image

You can edit a saved image. You can also edit an image in preview mode.

To edit a saved image, do the following:

1. Push the image archive button . This displays the *Gallery*.
2. Select a folder and push the navigation pad.
3. Select the image you want to edit and push the navigation pad.
4. Push the navigation pad to display the top toolbar.
5. On the top toolbar, select the  icon and push the navigation pad.
6. On the right toolbar, select the  icon and push the navigation pad. This opens the image in edit mode.
7. Manual image adjustment mode is now active. For image adjustment instructions, see section 11.3 *Adjusting the infrared image*.

8. Push the navigation pad. This displays a context menu.

- Select  (*Cancel*) to exit edit mode.
- Select  (*Measurement parameters*) to change the global parameters.
- Select  (*Image mode*) to change the image mode.
- Select  (*Measurement*) to add a measurement tool.
- Select  (*Color*) to change the color palette or set a color alarm.
- Select  (*Save*) to save and exit edit mode.

9. To store the edited image online, make a manual upload of the image. See section 9.6 *Manual upload*.



8.5.1 Related topics

- 11.6 *Changing the measurement parameters.*
- 12 *Working with image modes.*
- 13 *Working with measurement tools.*
- 11.5 *Changing the color palettes.*
- 14 *Working with color alarms and isotherms.*

8.6 Displaying the image information

The image information consists of items such as the date, emissivity, and atmospheric temperature. When you save an image, the image information is saved in the image file and can be viewed in the image archive (*Gallery*).

To display the image information, do the following:

1. Push the image archive button . This displays the *Gallery*.
2. Select a folder and push the navigation pad.
3. Select an image and push the navigation pad.
4. Push the navigation pad to display the top toolbar.
5. On the top toolbar, select the  icon and push the navigation pad.
6. On the right toolbar, select the  icon and push the navigation pad. This displays the image information.

8.7 Zooming an image

You can zoom an image by using the camera's digital zoom function. You can do this on live images and on saved images in edit mode.

The digital zoom factor is displayed at the top of the screen.

To digitally zoom an image, do the following:

- **Zoom in:** Touch the screen with two fingers and spread the fingers apart.
- **Zoom out:** Touch the screen with two fingers and pinch the fingers together.

8.8 Deleting images

You can delete image files from the memory card. For more information, see sections 10.9 *Deleting an image or video file*, 10.10 *Deleting multiple files*, and 10.11 *Deleting all files*.

8.9 Resetting the image counter

You can reset the numbering of the image filenames.

Note To prevent image files being overwritten, the new counter value will be based on the highest existing filename number in the image archive. To ensure that the counter is reset to 0001, insert an empty memory card before resetting the counter.

Follow this procedure:

1. Push the navigation pad to display the menu system.
2. Select  (*Settings*) and push the navigation pad. This displays the *Settings* menu.
3. Use the navigation pad to select *Device settings* > *Reset options* > *Reset image counter...*
4. Push the navigation pad. This displays a dialog box.
5. To reset the counter, select *Reset* and push the navigation pad.

FLIR Ignite is a cloud storage service for thermal images. Upload images from your camera and your data will be instantly available across all your devices. With FLIR Ignite you can edit images and create basic reports. You can also share images with colleagues and clients and invite team members to work in the same folder and files.

FLIR Ignite also includes a PC-based application called FLIR Ignite Sync that allows you to sync your image library with your computer. This gives you easy access to images when creating reports in FLIR Thermal Studio or other post-processing software.

9.1 Uploading to FLIR Ignite

You can set up the camera to upload images and videos to FLIR Ignite.

If automatic upload is enabled, new images and videos will automatically be uploaded to the FLIR Ignite account. You can also upload images and videos manually from the image archive.

To be able to upload images and videos, you need to connect the camera to the internet and pair the camera with a FLIR Ignite account.

9.2 Connecting to internet

You can connect the camera to the internet via Wi-Fi or Bluetooth.

9.2.1 Connecting to Wi-Fi

You can connect the camera to a Wi-Fi network as part of the initial setup of the camera. You can also connect the camera at any time via the *Settings* menu.

To connect to Wi-Fi via the *Settings* menu, do the following:

1. Select  (*Settings*) > *Connections* > *Wi-Fi* > *Connect to network*.
2. To display a list of the available networks, select *Available networks*.
3. Select one of the available networks and push the navigation pad.

Note Password-protected networks are indicated with a padlock icon, and for these you will need to enter a password the first time you connect to the network. After that the camera will connect automatically to the network. To disable the automatic connection, select *Forget network*.

Note To enable/disable the camera firewall, select *Connections* > *Advanced* > *Global firewall*.

9.2.2 Connecting via Bluetooth

If supported by your mobile phone, you can share the phone's internet connection with the camera via Bluetooth.

Note The Bluetooth protocol is limited in terms of data transfer and best suited for upload of single images. For upload of videos and folders with several images, it is recommended to use Wi-Fi.

To connect the camera to the internet via your mobile phone, do the following:

1. Select  (*Settings*) > *Connections* > *Bluetooth*.
2. Make sure Bluetooth is enabled by toggling the *Bluetooth* switch.

Note On the mobile phone, you must make sure that Bluetooth is enabled, that the phone is in discovery mode, and that Bluetooth tethering is enabled.

3. Select *Available devices* and push the navigation pad.
4. Wait until a list of available Bluetooth devices is displayed.
5. Select your mobile phone and begin the pairing procedure.

9.3 Creating a FLIR Ignite account

To create a FLIR Ignite account, go to <https://ignite.flir.com> and click *Sign up*.

9.4 Pairing with FLIR Ignite

You can pair the camera as part of the initial setup of the camera. You can also pair the camera at any time via the *Settings* menu.

To pair the camera via the *Settings* menu, do the following:

1. Make sure the camera is connected to the internet.
2. Select  (*Settings*) > *FLIR Ignite*.
3. Start the pairing procedure by selecting *Sign in*.
4. Use a computer or other device with internet access and go to the website displayed on the camera screen.
5. On the website, enter the code displayed on the camera screen.
6. Sign in to your FLIR Ignite account.

9.5 Automatic upload

You can set up the camera to automatically upload images and videos to your FLIR Ignite account.

When automatic upload is enabled, new images and videos will automatically be uploaded when the camera is connected to the internet and paired with FLIR Ignite.

To enable automatic upload, do the following:

1. Make sure the camera is paired with your FLIR Ignite account.
2. Select  (*Settings*) > *FLIR Ignite*.
3. Enable/disable automatic upload by toggling the *Auto upload* switch.



Note You can also enable automatic upload on the swipe-down menu. For more information, see section 6.4.4 *Swipe-down menu*.

9.6 Manual upload

You can manually upload images, videos, and folders from the image archive when the camera is paired with a FLIR Ignite account and connected to the internet.



You can monitor the upload progress at the top of the image archive.

9.6.1 Uploading an image/video file



1. Make sure the camera is connected to the internet.
2. Make sure the camera is paired with a FLIR Ignite account.
3. Push the image archive button .
4. Select a folder and then select an image or video.
5. Push the navigation pad to display the top toolbar.
6. On the top toolbar, select the  icon.
7. On the right toolbar, select the  icon.

9.6.2 Uploading multiple files

1. Make sure the camera is connected to the internet.
2. Make sure the camera is paired with a FLIR Ignite account.
3. Push the image archive button .

4. Select a folder.
5. On the top toolbar, select the  icon.
6. Select the images and videos you want to upload. Selected files are marked with a tick.
7. On the right toolbar, select the  icon.

9.6.3 Uploading folders

1. Make sure the camera is connected to the internet.
2. Make sure the camera is paired with a FLIR Ignite account.
3. Push the image archive button .
4. On the top toolbar, select the  icon.
5. Select the folders you want to upload. Selected folders are marked with a tick.
6. On the right toolbar, select the  icon.

9.7 Accessing FLIR Ignite

You can access FLIR Ignite from a browser on your desktop, tablet, or mobile device.

To access FLIR Ignite, go to <https://ignite.flir.com>.

For more information, refer to the FLIR Ignite user manual.

10.1 General



When you save an image or video clip, the camera stores the image/video file in the image archive on the memory card. You can open an image in the image archive and, for example, select another image mode, apply color alarms, and add measurement tools. You can also open and play saved video clips.

In the camera, the image archive is called *Gallery*. The *Gallery* can include one or several folders. New images and video clips will be saved to the active folder, at the top of the *Gallery*. You can create new folders, rename a folder, change the active folder, move files between the folders, and delete folders.



10.2 Opening image and video files



1. Push the image archive button . This displays the *Gallery* with one or more folders.
2. Select a folder and push the navigation pad.
3. Select the image or video clip you want to view and push the navigation pad.
4. Do one or more of the following:
 - To view the previous/next image or video clip, push the navigation pad left/right.
 - To display a toolbar at the top of the screen, push the navigation pad. Do one or more of the following:

Images:



- To switch between an infrared image and a visual image, select the  icon and push the navigation pad.
- To edit the image, delete the image, display information, or add annotations, select the  icon and push the navigation pad. This displays a menu to the right.

Video clips:

- Select the  icon and push the navigation pad. To play or pause the video clip, push the navigation pad.
- To delete the video or display information, select the  icon and push the navigation pad. This displays a menu to the right.

5. To return to the folder overview, push the back button .
6. To return to the *Gallery*, push the back button  again.



10.3 Creating a new folder

1. Push the image archive button . This displays the *Gallery*.
2. On the top toolbar, select the  icon and push the navigation pad.
3. A soft keyboard is displayed, where you can enter the name of the folder by touching the screen.
4. When completed, touch *Done* on the soft keyboard.
5. The new folder automatically becomes the active folder and appears at the top of the *Gallery*.

10.4 Renaming a folder

You can change the name of the folders in the archive. The active folder cannot be renamed.



To rename a folder, do the following:

1. Push the image archive button . This displays the *Gallery*.
2. On the top toolbar, select the  icon and push the navigation pad.
3. Select the folder to rename and push the navigation pad.
4. On the right toolbar, select the  icon and push the navigation pad.
5. A soft keyboard is displayed, where you can enter the new name of the folder by touching the screen.
6. When completed, touch *Done* on the soft keyboard.



10.5 Changing the active folder

New images and video clips are saved to the active folder.

To change the active folder, do the following:

1. Push the image archive button . This displays the *Gallery*.
2. On the top toolbar, select the  icon and push the navigation pad.
3. Select the folder that new images and video clips should be saved to and push the navigation pad. This marks the selected folder with a tick.
4. On the right toolbar, select the  icon and push the navigation pad.
5. The selected folder is moved to the top of the *Gallery*.

10.6 Moving files between folders



1. Push the image archive button . This displays the *Gallery*.
2. Select a folder and push the navigation pad.
3. On the top toolbar, select the  icon and push the navigation pad.
4. Use the navigation pad to select the image and video items you want to move. You can also select the items by touching the screen. Selected items are marked with a tick.
5. On the right toolbar, select the  icon and push the navigation pad.
6. Select the destination folder for the selected items and push the navigation pad.

10.7 Uploading files and folders

You can manually upload images, videos, and folders to your FLIR Ignite account when the camera is connected to the internet. For more information, see section 9.6 *Manual upload*.

10.8 Deleting a folder

You can delete a folder in the archive. The active folder cannot be deleted.



1. Push the image archive button . This displays the *Gallery*.
2. On the top toolbar, select the  icon and push the navigation pad.
3. Select the folder to delete and push the navigation pad.

-
4. On the right toolbar, select the  icon and push the navigation pad. This displays a dialog box.
 5. To delete the folder, select *Delete* and push the navigation pad.

10.9 Deleting an image or video file



You can delete an image or video file from the image archive.

Note When deleting an image file, both images in the image file (thermal and visual) will be deleted.

1. Push the image archive button . This displays the *Gallery*.
2. Select a folder and push the navigation pad.
3. Select the image or video clip you want to delete and push the navigation pad.
4. Push the navigation pad to display the top toolbar.
5. On the top toolbar, select the  icon and push the navigation pad.
6. On the right toolbar, select the  icon and push the navigation pad. This displays a dialog box.
7. To delete the image, select *Delete* and push the navigation pad.

10.10 Deleting multiple files

You can delete multiple image and video files from the image archive.

1. Push the image archive button . This displays the *Gallery*.
2. Select a folder and push the navigation pad.
3. On the top toolbar, select the  icon and push the navigation pad.
4. Use the navigation pad to select the image and video items you want to delete. You can also select the items by touching the screen. Selected items are marked with a tick.
5. On the right toolbar, select the  icon and push the navigation pad. This displays a dialog box.
6. To delete the selected items, select *Delete* and push the navigation pad.

10.11 Deleting all files

You can delete all image and video files from the memory card.

1. Push the navigation pad to display the menu system.
2. Select  (*Settings*) and push the navigation pad. This displays the *Settings* menu.
3. Use the navigation pad to select *Save options & storage > Delete all saved files... .*
4. Push the navigation pad. This displays a dialog box.
5. To permanently delete all saved files, select *Delete* and push the navigation pad.

11.1 General

A good image depends on several different functions and settings, although some functions and settings affect the image more than others.

These are the functions and settings that you need to experiment with:

- Adjusting the infrared camera focus.
- Adjusting the infrared image (automatically or manually).
- Selecting a suitable temperature range.
- Selecting a suitable color palette.
- Changing the measurement parameters.
- Performing a non-uniformity correction (NUC).

The following sections explain how to work with these functions and settings.

In some situations, you may also want to hide the overlay graphics for a better view.

11.2 Adjusting the infrared camera focus

It is very important to adjust the focus correctly. Incorrect focus adjustment affects how the image modes work. It also affects the temperature measurement.

11.2.1 Manual focus

You can adjust the focus manually by rotating the focus ring. For more information, see section 7.4.1 *Manual focus*.

11.2.2 Autofocus

You can autofocus the infrared camera by pushing the Autofocus button. For more information, see section 7.4.2 *Autofocus*.



WARNING

When the camera is set to autofocusing with the laser method (*Settings > Device settings > Focus > Auto focus > Laser*), do not point the camera at the face of a person when you use the autofocus function. The laser beam can cause eye irritation.

Note

- You can also assign the autofocus function to the programmable button. For more information, see section 7.9 *Programmable button*.
- Autofocus is not supported by all camera models.

11.2.3 Continuous autofocus

The infrared camera can be set up to perform continuous autofocusing. For more information, see section 7.4.3 *Continuous autofocus*.



WARNING

Do not point the camera at the face of a person when the continuous autofocus function is on. The camera uses laser distance measurements (that are continuous) for the focus adjustments. The laser beam can cause eye irritation.

Note Continuous autofocus is not supported by all camera models.

11.3 Adjusting the infrared image

11.3.1 General

An infrared image can be adjusted automatically or manually.

In automatic mode, the camera continuously adjusts the level and span for the best image presentation, using one of the following color distribution methods:



- *Histogram*: The colors are distributed based on the thermal content of the image.
- *Linear*: The colors are distributed evenly from the lowest to the highest temperature.

The color distribution method for the automatic mode is configured by a setting. Select  (*Settings*) > *Device settings* > *User interface options* > *Auto adjustment method*.

By using the *Auto adjustment region* feature it is possible to select an area of the image, and then have the colorization of the image adjusted based on the temperatures within that selected area. For more information, see section 11.3.2 *Auto adjustment region*.

In manual mode, you can adjust the temperature scale to values close to the temperature of a specific object in the image. This will make it possible to detect anomalies and smaller temperature differences in the part of the image of interest. In manual mode, the colors are distributed evenly from the lowest to the highest temperature (linear color distribution).

In manual mode, you can adjust the image by touching the screen or by using the navigation pad. For more information, see sections 11.3.3 *Manual adjustment by touching the screen* and 11.3.4 *Manual adjustment by using the navigation pad*.

- In live mode, select  (*Temperature scale*) and then  (*Auto*) or  (*Manual*) to enter automatic or manual image adjustment mode.
- In preview/edit mode, manual image adjustment mode is active.

Note You can also assign image adjustment functions to the programmable button. For more information, see section 7.9 *Programmable button*.

- *Switch between auto and manual*: Allows you to switch between automatic and manual image adjustment modes.
- *Auto adjust the manual temperature scale*: Allows you to perform an automatic adjustment of the image while remaining in manual image adjustment mode.

11.3.1.1 Example 1

Here are two infrared images of a building. In the left image, which is auto-adjusted, the large temperature span between the clear sky and the heated building makes a correct analysis difficult. You can analyze the building in more detail if you change the temperature scale to values close to the temperature of the building.

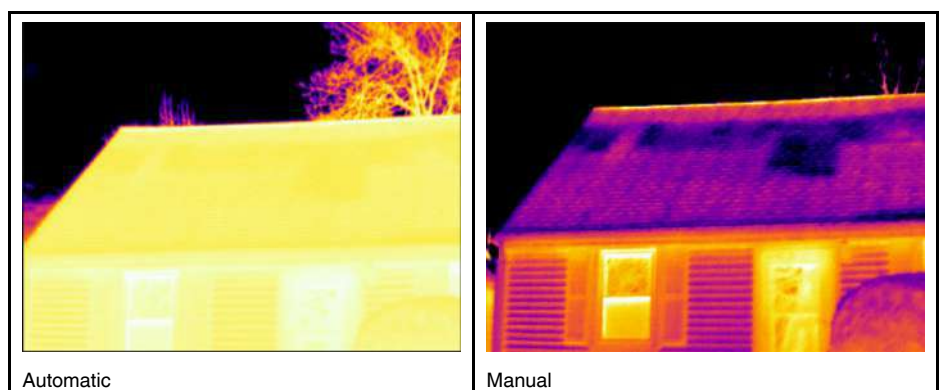

11.3.1.2 Example 2

Here are two infrared images of an isolator in a power line. To make it easier to analyze the temperature variations in the isolator, the temperature scale in the right image has been changed to values close to the temperature of the isolator.

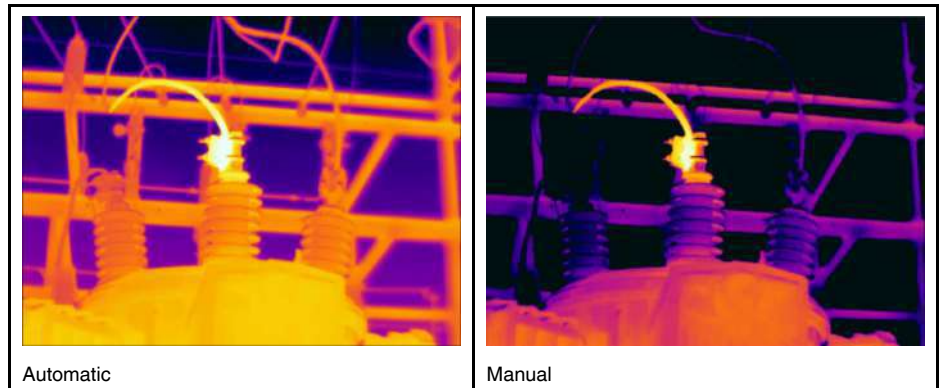

11.3.2 Auto adjustment region

When you auto-adjust a thermal image, you adjust it for the best image brightness and contrast. This means that the color information is distributed over the existing temperatures of the image.

In some situations, the image may contain very hot or very cold areas outside your area of interest. In such cases you might want to exclude those areas and use the color information only for the temperatures in your area of interest. You can do so by selecting a smaller auto adjustment region.

Select the auto adjustment region under  (Settings) > Device settings > User interface options > Auto adjustment region.

11.3.3 Manual adjustment by touching the screen

11.3.3.1 General

The touch functionality for manual image adjustments is enabled/disabled by a setting.

Select  (Settings) > Device settings > User interface options > Manual adjustment using touch > On/Off.



When manual image adjustment mode is active, an adjustment wheel is displayed to the right of the temperature scale. (Applicable when the manual adjustment by touch functionality is enabled.)



Figure 11.1 Manual adjustment mode active

11.3.3.2 Procedure

1. In live mode, push the navigation pad to display the menu system.

2. Select  (*Temperature scale*) and push the navigation pad. This displays a submenu.
3. Select  (*Manual*) and push the navigation pad.
4. To simultaneously change the temperature scale minimum and maximum limits, place your finger on the screen and move it up/down.
5. To change the minimum limit or the maximum limit, do the following:
 - Touch the maximum or minimum temperature that you want to change.
 - Place your finger on the screen and move it up/down to change the value of the highlighted temperature.

11.3.3.3 Auto-adjusting the image in manual mode

In manual image adjustment mode, you can auto-adjust the image by touching the screen. The image will be auto-adjusted based on the thermal content of the area around the touched point. The top and bottom levels in the temperature scale will be set to the maximum and minimum temperatures in that area. By using the color information only for the relevant temperatures, you will get more details in your area of interest.



11.3.3.4 Locking the touch screen

When you have adjusted the image to levels that allow you to study your area of interest, you can lock the touch screen to prevent further unintentional adjustments.

To lock the screen, touch the  icon to the left of the temperature scale.

To unlock the screen, touch the  icon to the left of the temperature scale.

Note If you switch to automatic image adjustment mode, the screen automatically unlocks and your manual adjustments are lost.

11.3.4 Manual adjustment by using the navigation pad

11.3.4.1 Manual adjustment modes

There are two different settings for the manual adjustment mode (applicable for the navigation pad only):



- *Level, Span*: With this setting, you can manually adjust the level and span by using the navigation pad.
- *Level, Max, Min*: With this setting, you can manually adjust the level by using the navigation pad. You can also change the upper and lower temperatures individually.

Select the type of manual image adjustment mode under  (*Settings*) > *Device settings* > *User interface options* > *Manual adjustment mode*.

11.3.5 Manual adjustment in *Level, Span* mode

Note This procedure assumes that you have configured the camera for manual image adjustments in *Level, Span* mode. Select *Settings > Device settings > User interface options > Manual adjustment mode = Level, Span*.



Follow this procedure:

1. In live mode, push the navigation pad to display the menu system.
2. Select  (*Temperature scale*) and push the navigation pad. This displays a submenu.
3. Select  (*Manual*) and push the navigation pad.
4. Push the navigation pad up/down to increase/decrease the level.
5. Push the navigation pad left/right to increase/decrease the span.

11.3.6 Manual adjustment in *Level, Max, Min* mode

Note This procedure assumes that you have configured the camera for manual image adjustments in *Level, Max, Min* mode. Select *Settings > Device settings > User interface options > Manual adjustment mode = Level, Max, Min*.

Follow this procedure:

1. In live mode, push the navigation pad to display the menu system.
2. Select  (*Temperature scale*) and push the navigation pad. This displays a submenu.
3. Select  (*Manual*) and push the navigation pad.
4. To simultaneously change the temperature scale minimum and maximum limits, push the navigation pad up/down.
5. To change the minimum limit or the maximum limit, do the following:
 - Push the navigation pad left/right to select (highlight) the maximum or minimum temperature.
 - Push the navigation pad up/down to change the value of the highlighted temperature.

11.4 Changing the camera temperature range

The camera is calibrated for different temperature ranges. Available temperature range options are dependent on the camera model.

For accurate temperature measurements, you must change the *Camera temperature range* setting to suit the expected temperature of the object you are inspecting.

Note For more information, see section 28 *About calibration*.

Follow this procedure:





1. Push the navigation pad to display the menu system.
2. Select  (*Settings*) and push the navigation pad. This displays the *Settings* menu.
3. Select *Camera temperature range* and push the navigation pad. This displays a dialog box.
4. Select the appropriate temperature range and push the navigation pad.

Note You can also assign the function *Switch temperature range* to the programmable button. For more information, see section 7.9 *Programmable button*.

11.5 Changing the color palettes

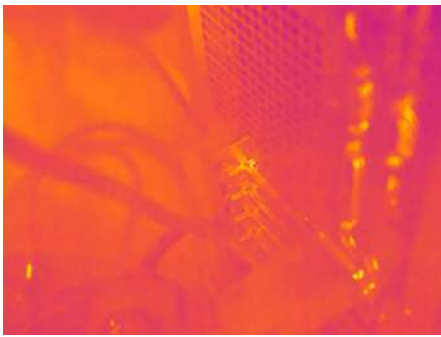
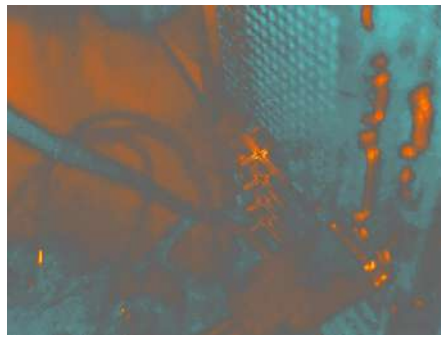
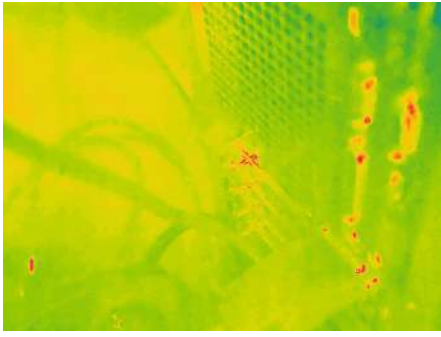
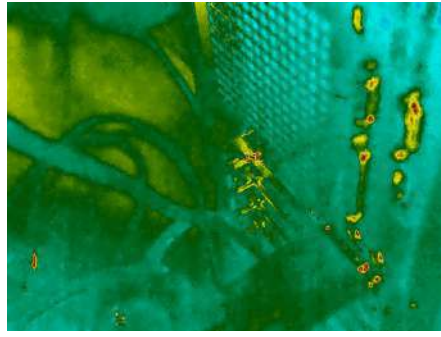
You can change the color palette that the camera uses to display different temperatures. A different palette can make it easier to analyze an image.

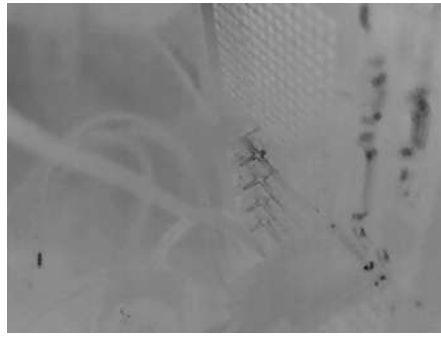
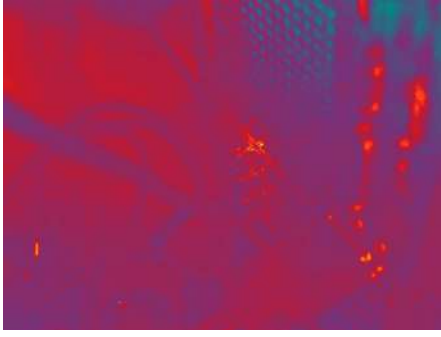
This table explains the different types of color palettes.

	
Iron	Arctic
	
Rainbow	Rainbow high contrast
	
White hot	Black hot
	
Lava	

Follow this procedure:

1. Push the navigation pad to display the menu system.
2. Select  (*Color*) and push the navigation pad. This displays a submenu.
3. Use the navigation pad to select a different palette.

-
4. Push the navigation pad to confirm and exit the menu mode.

11.6 Changing the measurement parameters

For accurate measurements, it is important to set the measurement parameters:

- *Emissivity.*
- *Reflected temperature.*
- *Object distance.*
- *Atmospheric temperature.*
- *Relative humidity.*
- *External IR window compensation.*

Emissivity is the most important measurement parameter to set correctly. If the *Emissivity* is set to a low value, the *Reflected temperature* also becomes important. The parameters *Object distance*, *Atmospheric temperature*, and *Relative humidity* are relevant for longer distances. The *External IR window compensation* must be activated if a protective window or external lens is used.

You can set the measurement parameters globally. You can also change the *Emissivity*, *Reflected temperature*, and *Object distance* parameters locally for a measurement tool.

For more information, see section 13.5 *Changing the measurement parameters*.

11.7 Performing a non-uniformity correction (NUC)

11.7.1 General

When the thermal camera displays *Calibrating...* it is performing what in thermography is called a "non-uniformity correction" (NUC). An NUC is *an image correction carried out by the camera software to compensate for different sensitivities of detector elements and other optical and geometrical disturbances*⁶. For more information, see section 28 *About calibration*.

An NUC is performed automatically, for example at start-up, when changing a measurement range, or when the environment temperature changes.

You can also perform an NUC manually. This is useful when you have to perform a critical measurement with as little image disturbance as possible. You may, for example, want to perform a manual calibration just before you start recording a video sequence.

11.7.2 Performing an NUC manually

To perform a manual NUC, push and hold down the image archive button  for more than 2 seconds.

Note You can also assign the function *Calibrate* to the programmable button. For more information, see section 7.9 *Programmable button*.

11.8 Hiding all overlay

The camera overlay consists of overlay graphics and image overlay information. The overlay graphics include items such as measurement tool symbols, result tables, and status icons. The image overlay information, which you activate on the *Settings* menu, provides additional information such as the date, emissivity, and atmospheric temperature. For more information, see section 6.4.5 *Image overlay information*.

6. Definition from the European standard EN 16714-3:2016, Non-destructive Testing—Thermographic Testing—Part 3: Terms and Definitions.

You can choose to hide all camera overlay by pressing the programmable button.

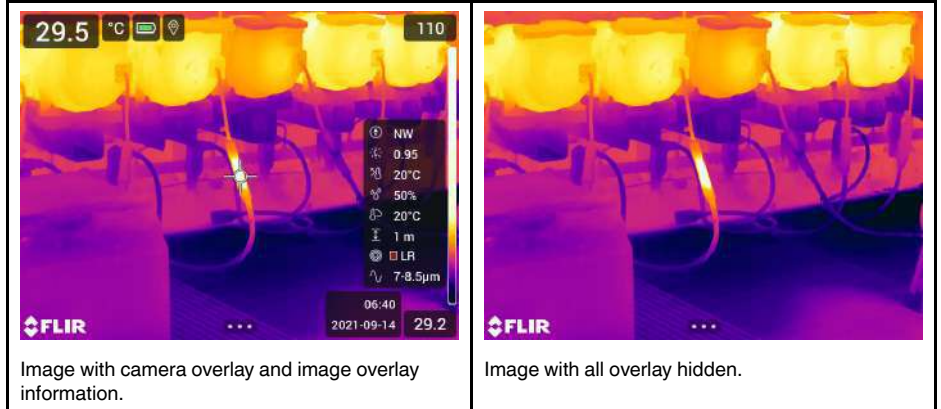

Follow this procedure:

1. Push and hold the programmable button. This displays the *Programmable button* menu.
2. Push the navigation pad up/down to select the function *Hide image overlay graphics*.
3. Push the navigation pad to confirm and exit the menu mode.

12.1 General

The camera can capture both thermal and visual images at the same time. By choosing the image mode, you select which type of image to display on the screen.

The camera supports the following image modes:

- *Thermal*: An infrared image is displayed.
- *Thermal MSX* (Multi Spectral Dynamic Imaging): The camera displays an infrared image where the edges of the objects are enhanced with visual image details.
- *Picture in picture*: An infrared image frame is displayed on top of the visual image.
- *Digital camera*: The visual image captured by the digital camera is displayed.

Note

- For the *Thermal MSX*, *Thermal*, and *Picture in picture* image modes, all thermal and visual information is stored when an image is saved. This means that you can edit the image later, in the image archive or in a FLIR Thermography software, and select any of the image modes.
- For the *Digital camera* image mode, a digital image with full resolution (5 MP) is stored when an image is saved. However, no thermal information is stored.
- You can choose to turn off the digital camera. This can, for example, be required in restricted areas and in confidential (e.g., doctor/patient) situations. Select  (*Settings*) > *Save options & storage* > *Digital camera* = *Off*. When the digital camera is off, only the image mode *Thermal* is enabled.
- The availability of the digital camera depends on the lens model.
- The *Thermal MSX*, *Thermal*, and *Picture in picture* image modes only work correctly for calibrated lenses. The lens that ships with the camera is factory calibrated. To calibrate a new lens, see section 7.16 *Calibrating the lens-camera combination*.



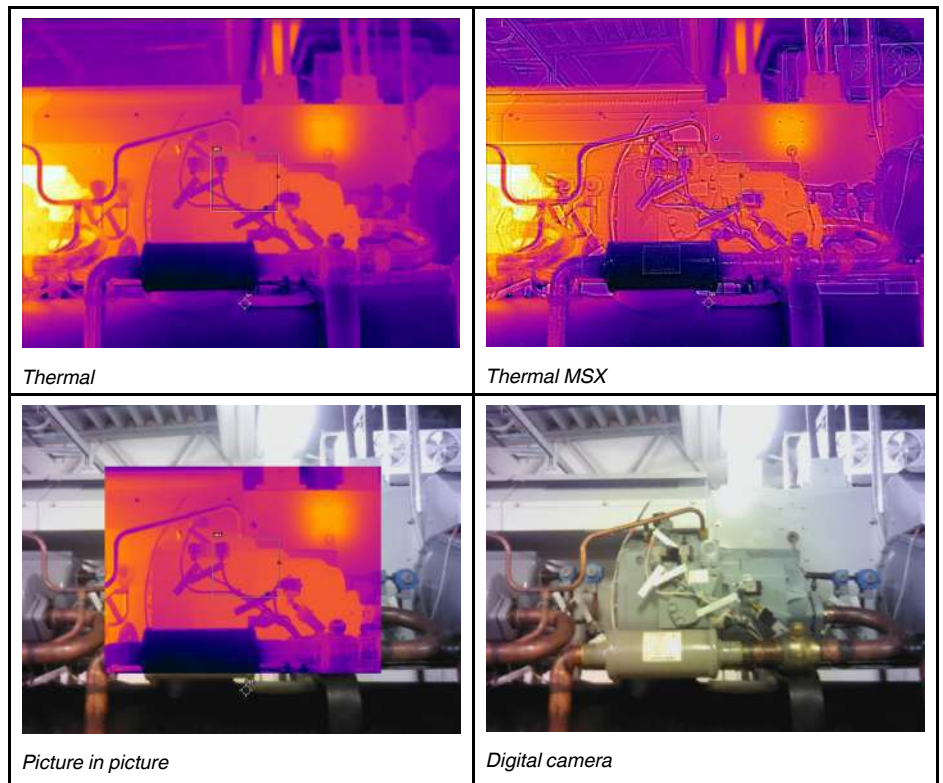

12.2 Image examples

This table explains the different types of image modes.



12.3 Selecting an image mode

Follow this procedure:

1. Push the navigation pad to display the menu system.
2. Select  (*Image mode*) and push the navigation pad. This displays a submenu.
3. Use the navigation pad to select one of the following:
 -  (*Thermal MSX*).
 -  (*Thermal*).
 -  (*Picture in picture*).
 -  (*Digital camera*).
4. Push the navigation pad to confirm and exit the menu mode.
5. If *Picture in picture* mode is selected, you can at this point move and resize the infrared image frame. (For some camera models, the image frame is locked in the center and cannot be moved.) Do the following:
 - 5.1. To activate the *Picture in picture* tool, touch a corner of the infrared image frame. The tool is now displayed showing five handles, one in the middle and one in every corner of the frame.
 - 5.2. To move the frame, touch and hold the middle handle and drag the frame.
 - 5.3. To resize the frame, touch and hold one of the corner handles and drag the corner of the frame.









13.1 General

To measure a temperature, you can use one or more measurement tools, e.g., a spot-meter or a box.



13.2 Adding/removing measurement tools

Follow this procedure:

1. Push the navigation pad to display the menu system.
2. Select  (*Measurement*) and push the navigation pad. This displays a submenu.
3. Use the navigation pad to select one of the following:
 - Select  (*No measurements*) to remove all tools.
 - Select  (*Center spot*) to add a center spot.
 - Select  (*Hot spot*) to add a hot spot detection within a box area.
 - Select  (*Cold spot*) to add a cold spot detection within a box area.
 - Select (depending on the camera model)  (*User preset 1*) to add user preset 1 or  (*3 spots*) to add three spots.
 - Select (depending on the camera model)  (*User preset 2*) to add user preset 2 or  (*Hot spot - Spot*) to add a hot spot and a spot and display the temperature difference.
4. Push the navigation pad to confirm and exit the menu mode.











13.3 Editing user presets

Note The availability of this feature is dependent on the camera model.

A user preset is a measurement tool, or a group of measurement tools, with predefined characteristics.

Follow this procedure:

1. Push the navigation pad to display the menu system.

2. Select  (*Measurement*) and push the navigation pad. This displays a submenu.
3. Use the navigation pad to select  (*User preset 1*) or  (*User preset 2*).
4. Push and hold the center of the navigation pad. This displays the *Edit user preset* menu.
5. Select  (*Add measurement*) and push the navigation pad. This displays a submenu.
6. Use the navigation pad to select one of the following:
 - Select  (*Add spot*) to add a spot.
 - Select  (*Add box*) to add a box.
 - Select  (*Add circle*) to add a circle.
 - Select  (*Add delta*) to set up a differential calculation.
7. Push the navigation pad. This displays the measurement tool on the screen.
8. Push the navigation pad. This displays a context menu, where you can select one or more of the following actions (depending on the type of tool):
 - Remove the tool.
 - Resize, move, center, and rotate the tool.
 - Set alarms.
 - Display maximum, minimum, average, and area values.
 - Set local parameters.
- When completed, select  (*Done*) and push the navigation pad.
9. When all measurement tools have been added, select  (*Save as user preset*).
10. Push the navigation pad to confirm and exit the menu mode.

13.4 Moving and resizing a measurement tool

13.4.1 General



You can move and resize a measurement tool.

Note When you select another measurement tool, any changes of position and size of the current tool will be lost. If you wish to keep the position and size settings, use the user preset feature, see section 13.3 *Editing user presets*.

13.4.2 Moving a spot

Note You can also move the spot by touching the screen.





Follow this procedure:

1. To select the spot, touch the tool on the screen. The tool is now displayed with a frame.
2. Push the navigation pad—or touch and hold the tool. This displays a context menu.
3. To move the spot, do the following:
 - 3.1. Select  (*Move spot*) and push the navigation pad.
 - 3.2. Push the navigation pad up/down and left/right to move the spot.
4. To center the spot, select  *Center spot* and push the navigation pad.
5. When completed, push the navigation pad and select  (*Done*).
6. Push the navigation pad to confirm and exit the menu mode.

13.4.3 Moving and resizing a box or circle tool

Note You can also move and resize the measurement tool by touching the screen.

Follow this procedure:

1. To select the measurement tool, touch the tool on the screen. The tool is now displayed with one or more handles.
2. Push the navigation pad—or touch and hold the tool. This displays a context menu.
3. Select  (*Move/resize*) and push the navigation pad. This displays a submenu.
4. Use the navigation pad to select one of the following:
 - Select  (*Resize*) to change the size of the tool.
 - Select  (*Move*) to move the tool.
 - Select  (*Center box/circle*) to center the tool.
5. Push the navigation pad up/down and left/right to resize or move the tool.
6. When completed, push the navigation pad and select  (*Done*).
7. Push the navigation pad to confirm and exit the menu mode.

13.5 Changing the measurement parameters

13.5.1 General

For accurate measurements, it is important to set the measurement parameters.

Note During normal operation there is typically no need to change the default measurement parameters, see section 13.5.3 *Recommended values*.

13.5.2 Types of parameters

The camera can use these measurement parameters:

- *External IR window compensation*, i.e., the temperature of any protective windows, external lenses (e.g., the close-up lens), etc., that are set up between the camera and the object of interest. If no protective window, protective shield, or external lens is used, this value is irrelevant and should be left inactive.
- *Object distance*, i.e., the distance between the camera and the object of interest.

Note The camera can be configured to automatically measure the distance when an image is saved. With this setting, the *Object distance* parameter in the image data is automatically updated with the measured distance when an image is saved. (There is no effect on the *Object distance* setting in live mode.) For more information, see section 6.3 *Laser distance meter and laser pointer*.

- *Atmospheric temperature*, i.e., the temperature of the air between the camera and the object of interest.
- *Relative humidity*, i.e., the relative humidity of the air between the camera and the object of interest.
- *Reflected temperature*, which is used when compensating for the radiation from the surroundings reflected by the object into the camera. This property of the object is called “reflectivity.”
- *Emissivity*, i.e., how much radiation an object emits, compared with the radiation of a theoretical reference object at the same temperature (called a “blackbody”). The opposite of emissivity is reflectivity. The emissivity determines how much of the radiation originates from the object as opposed to being reflected by it.

Note There is an *Emissivity mode* setting, which you can use to enter the emissivity by material instead of by value. Select  (*Settings*) > *Device settings* > *User interface options* > *Emissivity mode* > *Select from materials table*.

Emissivity is the most important measurement parameter to set correctly. If the *Emissivity* is set to a low value, the *Reflected temperature* also becomes important. The parameters *Object distance*, *Atmospheric temperature*, and *Relative humidity* are relevant for longer distances. The *External IR window compensation* must be activated if a protective window or external lens is used.

13.5.3 Recommended values

If you are unsure about the values, the following are recommended:

Object distance	1.0 m (3.3 ft.)
Atmospheric temperature	20°C (69°F)
Relative humidity	50%
Reflected temperature	20°C (69°F)
Emissivity	0.95

13.5.4 Procedure







You can set the measurement parameters globally. You can also change the *Emissivity*, *Reflected temperature*, and *Object distance* parameters locally for a measurement tool.

Local parameters are normally only effective for a fixed setup, where each measurement tool is set for a specific object of interest. For a general handheld application, the global parameters are usually sufficient.

Note *Emissivity* and *Reflected temperature* are the two most important measurement parameters to set correctly in the camera.

13.5.4.1 Setting global parameters

Follow this procedure:



1. Push the navigation pad to display the menu system.
2. Select  (*Measurement parameters*) and push the navigation pad. This displays a submenu.
3. Use the navigation pad to select one or more of the global measurement parameters:
 -  (*External IR window compensation*).
 -  (*Object distance*).
 -  (*Atmospheric temperature*).
 -  (*Relative humidity*).
 -  (*Reflected temperature*).
 -  (*Emissivity*).
4. Push the navigation pad to display a dialog box.
5. Use the navigation pad to change the parameter.
6. Push the navigation pad to confirm and exit the menu mode.

13.5.4.2 Changing local parameters

You can change the local parameters for a measurement tool.

A *P* next to the measurement tool on the screen indicates that local parameters have been activated for the tool.

Follow this procedure:









1. To select the measurement tool, touch the tool on the screen. The tool is now displayed with one or more handles.
2. Push the navigation pad—or touch and hold the tool. This displays a context menu.
3. Select  (*Use local parameters*) and push the navigation pad.
4. Push the navigation pad to activate the use of local parameters. This displays a submenu.
5. Use the navigation pad to select one or more of the local measurement parameters.
6. Push the navigation pad to display a dialog box.
7. Use the navigation pad to change the parameter.
8. Push the navigation pad. This closes the dialog box.
9. When completed, push the navigation pad and select  (*Done*).
10. Push the navigation pad to confirm and exit the menu mode.

Note When you select another measurement tool, the local parameters are reset. If you wish to keep the local parameter settings, use the user preset feature, see section 13.3 *Editing user presets*.

13.6 Displaying values in the result table

For the box and circle tools, you can set the camera to display the maximum, minimum, average, and area values in the result table.

Follow this procedure:

1. To select the measurement tool, touch the tool on the screen. The tool is now displayed with one or more handles.
2. Push the navigation pad—or touch and hold the tool. This displays a context menu.
3. Use the navigation pad to select  (*Max/Min/Avg*).
4. Push the navigation pad. This displays a submenu.
5. Use the navigation pad to select one or more of the following:
 - Select  (*Max*) to display the maximum value.
 - Select  (*Min*) to display the minimum value.
 - Select  (*Avg*) to display the average value.
 - Select (depending on the tool)  or  (*Area*) to display the area of an object within the measurement tool⁷. Area measurements require that the laser is enabled (*Settings > Device settings > Lamp & laser > Enable lamp & laser*). For more information, see section 7.6 *Measuring areas*.
 - Select  (*Max & min markers*) to display the maximum and minimum markers (the hot/cold spots).
6. Push the navigation pad to toggle the function between inactive and active.
7. When completed, push the navigation pad down to close the submenu.
8. Select  (*Done*) and push the navigation pad.

⁷ The availability of this feature is dependent on the camera model.





13.7 Creating and setting up a difference calculation

A difference calculation gives the difference between the values of two known measurement results.

Note

- You can set up a difference calculation when previewing an image or when editing an image in the archive.
- Depending on the camera model, you can also set up a difference calculation when defining user presets or by selecting the measurement tool *Hot spot - Spot*.
- This procedure assumes that you have previously laid out at least one measurement tool on the screen.

Follow this procedure:

1. To set up a difference calculation, do the following:
 - If you are defining user presets, select  (*Add measurement*) and then select  (*Add delta*).
 - If you are editing an image in the archive, select  (*Measurement*) and then select  (*Add delta*).
2. Push the navigation pad. This displays a dialog box where you can select the measurement tools that you want to use in the difference calculation. You can also select a fixed-temperature reference.
3. Push the navigation pad. The result of the difference calculation is now displayed on the screen.

13.8 Setting a measurement alarm

13.8.1 General

You can make the camera trigger an alarm when certain measurement conditions are met.



13.8.2 Types of alarm

You can choose between the following alarm types:

- *Above*: Triggers an alarm when the temperature is above the preset alarm temperature.
- *Below*: Triggers an alarm when the temperature is below the preset alarm temperature.

13.8.3 Alarm signals

When an alarm is set, the symbol  is displayed in the result table.

When an alarm is triggered, the value in the result table is displayed in red (above alarm) or blue (below alarm) and the symbol  (above alarm) or  (below alarm) is blinking. You can also set an audible alarm (there will be a “beep” when the alarm is triggered).

13.8.4 Procedure

There are different procedures for setting up an alarm for a spot, for a box or circle, and for a difference calculation.

13.8.4.1 Setting up an alarm for a spot

Follow this procedure:

1. To select the spot, touch the tool on the screen. The tool is now displayed with a frame.
2. Push the navigation pad—or touch and hold the tool. This displays a context menu.
3. Select  (*Set alarm on spot*) and push the navigation pad. This displays a dialog box.
4. In the dialog box, you can define the settings for the alarm.
 - *Alarm condition*: The condition that triggers the alarm. Applicable values are *Above*, *Below*, or *Off*.
 - *Alarm limit*: The temperature value that will be the critical condition when an alarm is triggered or not.
 - *Alarm sound*: Applicable values are *Beep* or *No sound*.
5. Push the navigation pad. This closes the dialog box.

13.8.4.2 Setting up an alarm for a box or circle

Note This procedure assumes that you have previously set the camera to display at least one value (maximum, minimum, or average) in the result table. For more information, see section 13.6 *Displaying values in the result table*.

Follow this procedure:



1. To select the measurement tool, touch the tool on the screen. The tool is now displayed with one or more handles.
2. Push the navigation pad—or touch and hold the tool. This displays a context menu.
3. Select  (*Set alarm*) and push the navigation pad. This displays a dialog box.
4. In the dialog box, you can define the settings for the alarm.
 - *Alarm condition*: The condition that triggers the alarm. Applicable values are *Above*, *Below*, or *Off*.
 - *Select measurement*: Applicable settings are the values you have previously defined (*Max*, *Min*, and/or *Avg*).
 - *Alarm limit*: The temperature value that will be the critical condition when an alarm is triggered or not.
 - *Alarm sound*: Applicable values are *Beep* or *No sound*.
5. Push the navigation pad. This closes the dialog box.

13.8.4.3 Setting up an alarm for a difference calculation

Note

- You can set up an alarm for a difference calculation when defining user presets (depending on the camera model), or when editing an image in the archive.
- This procedure assumes that you have previously set up a difference calculation.

To set up an alarm for a difference calculation, do the following:

1. If you are editing an image in the archive, select  (*Measurement*).
2. Select  (*Select*) and push the navigation pad. This displays a dialog box.
3. Select *Delta* and push the navigation pad. This displays a context menu.
4. Select  (*Set alarm on delta*) and push the navigation pad. This displays a dialog box.

5. In the dialog box, you can define the settings for the alarm.
 - *Alarm condition*: The condition that triggers the alarm. Applicable values are *Above*, *Below*, or *Off*.
 - *Alarm limit*: The temperature value that will be the critical condition when an alarm is triggered or not.
 - *Alarm sound*: Applicable values are *Beep* or *No sound*.
6. Push the navigation pad. This closes the dialog box.

Working with color alarms and isotherms



14.1 Color alarms

By using color alarms (isotherms), anomalies can easily be discovered in an infrared image. The isotherm command applies a contrasting color to all pixels with a temperature above, below, or between the set temperature levels. The camera also features isotherm types that are specific to the building trade: condensation and insulation alarms.



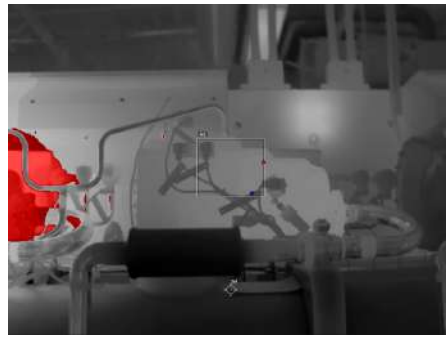
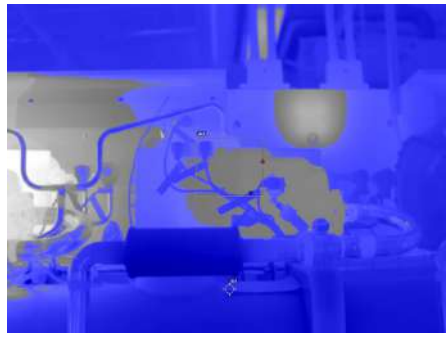
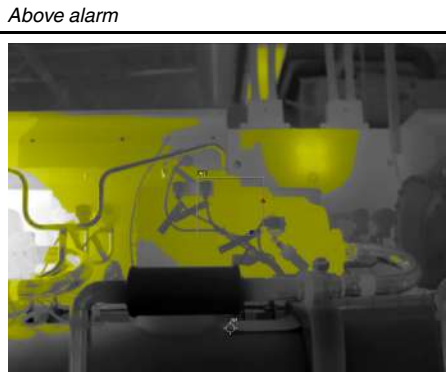

You can make the camera trigger the following types of color alarms:

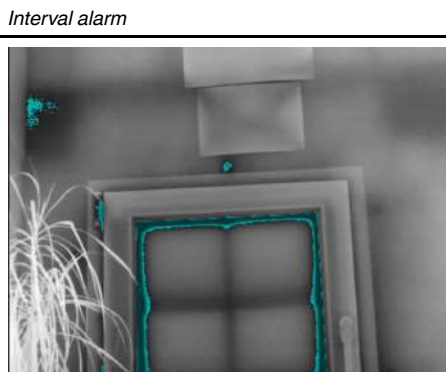
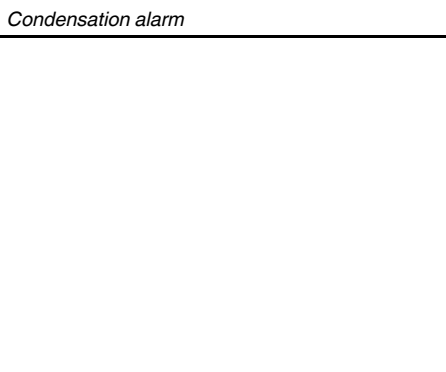
- *Above alarm*: This will apply a contrasting color to all pixels with a temperature above the specified temperature level.
- *Below alarm*: This will apply a contrasting color to all pixels with a temperature below the specified temperature level.
- *Interval alarm*: This will apply a contrasting color to all pixels with a temperature between two specified temperature levels.
- *Condensation alarm*: Triggers when the camera detects a surface where the relative humidity exceeds a preset value.
- *Insulation alarm*: Triggers when there is an insulation deficiency in a wall.

This table explains the different color alarms (isotherms).

14.1.1 Setting up above, below, and interval alarms

1. Push the navigation pad to display the menu system.
2. Select  (*Color*) and push the navigation pad. This displays a submenu.
3. Use the navigation pad to select one of the following:
 -  (*Above alarm*).
 -  (*Below alarm*).
 -  (*Interval alarm*).
4. Push the navigation pad. This displays a dialog box where you can define the settings for the alarm.

For the *Above alarm* and *Below alarm*, the following parameters can be set:

 - *Temperature limit*.
 - *Palette*.

For the *Interval alarm*, the following parameters can be set:

 - *Low temperature*.
 - *High temperature*.
 - *Palette*.
5. Push the navigation pad. This closes the dialog box.

14.1.2 Building isotherms

Note The Condensation and Insulation alarms are not supported by all camera models.

14.1.2.1 About the Condensation alarm



To detect areas with potential moisture problems, you can use the *Condensation alarm*. You can set the relative humidity above which the isotherm will colorize the image.

14.1.2.2 About the Insulation alarm

The *Insulation alarm* can detect areas where there may be an insulation deficiency in the building. It will trigger when the insulation level (which is called the thermal index in the camera) falls below a preset value of the energy leakage through a wall.

Different building codes recommend different values for the insulation level, but typical values are 60–80% for new buildings. Refer to your national building code for recommendations.

14.1.2.3 Setting up condensation and insulation alarms

1. Push the navigation pad to display the menu system.
2. Select  (*Color*) and push the navigation pad. This displays a submenu.
3. Use the navigation pad to select one of the following:
 -  (*Condensation alarm*).
 -  (*Insulation alarm*).

4. Push the navigation pad. This displays a dialog box where you can define the settings for the alarm.

For the *Condensation alarm*, the following parameters can be set:

- *Atmospheric temperature*: The current atmospheric temperature.
- *Relative humidity*: The current relative humidity.
- *Relative humidity limit*: The relative humidity level at which you want the alarm to be triggered. A relative humidity of 100% means that water vapor condenses from the air as liquid water (= dewpoint). A relative humidity of about 70% or above can cause mold.

For the *Insulation alarm*, the following parameters can be set:

- *Indoor temperature*: The current indoor temperature.
- *Outdoor temperature*: The current outdoor temperature.
- *Thermal index*: The insulation level (an integer between 0 and 100).

5. Push the navigation pad. This closes the dialog box.

15.1 General

You can save additional information with an infrared image by using annotations. Annotations make reporting and post-processing more efficient by providing essential information about the image, e.g., conditions and information about where an image is taken.

Annotations are added to the image file and can be viewed and edited in the camera or in a FLIR Thermography software.



- You can set the camera to display annotation tools when an image is saved. Select  (Settings) > Save options & storage > Add annotation after saving.
- You can also add annotations to a saved image in the image archive.

Note This section describes the procedures for adding annotations to a saved image in the image archive. Adding annotations when saving an image works in a similar way.

15.2 Adding a note

You can add a text note to the image file. Using this feature, you can annotate images by entering free-form text.

Follow this procedure:





1. Open the image in the image archive.
2. Push the navigation pad to display the top toolbar.
3. On the top toolbar, select the  icon and push the navigation pad.
4. On the right toolbar, select the  icon and push the navigation pad.
5. A soft keyboard is displayed, where you can enter text by touching the screen.
6. When completed, touch *Done* on the soft keyboard.

15.3 Adding a text comment table

You can save a table with textual information to the image file. This feature is a very efficient way of recording information when you are inspecting a large number of similar objects. The idea behind using a table with textual information is to avoid filling out forms or inspection protocols manually.

The camera ships with an example text comment table template. You can also create your own templates. For more information, see section 15.3.1 *Creating a text comment table template*.

Follow this procedure:

1. Open the image in the image archive.
2. Push the navigation pad to display the top toolbar.
3. On the top toolbar, select the  icon and push the navigation pad.
4. On the right toolbar, select the  icon and push the navigation pad. This displays a table.
5. (Optional step.) On the top toolbar, do one of the following:
 - To clear the content of the current table, select the  icon and push the navigation pad.
 - To select another table template, select the  icon and push the navigation pad.

6. For each row in the table, do the following:

- Push the navigation pad. This displays the predefined values.
- Push the navigation pad up/down to select a predefined value. Push the navigation pad to confirm.
- Instead of selecting a predefined value, you can select the keyboard  icon and enter other text by touching the screen.

Note Text entered by the keyboard will be saved to the text comment table template. Next time you add a text comment table annotation, the entered text will be displayed as a predefined value.

7. When completed, select *Save & Exit* at the bottom of the table. Push the navigation pad to confirm.

15.3.1 Creating a text comment table template

You can create a text comment file manually. You can also create a text comment file using a FLIR Thermography software.

15.3.1.1 Manually creating a table template

A text comment file (*.tcf) is an annotation format that is proprietary to FLIR Systems. It defines a table structure that can be used to add text table annotations to FLIR images. You can create text comment files (*.tcf files) and use these files as table templates in the camera.

The camera ships with an example text comment table file: `example_text_comment.tcf`. The file is stored on the memory card in the subfolder `\TextTableTemplates`. You can make a copy of the example file and modify it using a text editor such as Microsoft Notepad.

When creating or modifying a text comment file, keep the following rules in mind:

1. Lines starting with “#” are regarded as comments and will be ignored.
2. Lines that start with “<” and end with “>” are labels and will appear on the left-hand side of the table.
3. Non-empty lines under a label line are regarded as values and will be displayed as options to the label above.
4. When you save the file, select UTF-8 encoding. With UTF-8 encoding, the file will support all languages currently supported by the camera.
5. The template will be updated by the camera if you add or remove values in the text table annotations dialog in the camera. This enables you to modify its content while you are working with the camera.
6. The camera will find all text table template files if:
 - They are placed on the memory card in the subfolder `\TextTableTemplates`.
 - They have an ASCII filename and the file extension `.tcf`. (ASCII characters include a–z, A–Z, 0–9, and basic punctuation, and spaces can be used. The file can contain non-ASCII text, but the filename must be ASCII.)

15.3.1.1.1 Example mark-up structure

The file format for the text comment table template is *.tcf. This code sample is an example mark-up structure of such a file, and shows how the mark-up appears in a text editor such as Notepad.

```
<Site>
Company A
Company B
<Location>
Substation A
<Object>
Engine
Vent
```

```

Vault
Door
<ObjectID>
Ala1
Alb2
Alc3
<Deviation>
Overload
Moisture
Draft
<Remedy>
Replace
Fix
No action
<Severity>
Critical
Non-critical
<Severity>







```

15.4 Adding a voice annotation

A voice annotation is an audio recording that is saved to the infrared image file. The recording can be played back in the camera, and in image analysis and reporting software from FLIR Systems.

The voice annotation is recorded using the built-in microphone. You can also use a Bluetooth-enabled headset. For information on how to pair a headset with the camera, see section 21 *Pairing Bluetooth devices*.



Follow this procedure:





1. Open the image in the image archive.
2. Push the navigation pad to display the top toolbar.
3. On the top toolbar, select the  icon and push the navigation pad.
4. On the right toolbar, select the  icon and push the navigation pad.
5. A context menu is displayed.
6. To start a recording, select  (*Record*) and push the navigation pad.
7. To stop the recording, select  (*Stop*) and push the navigation pad.
8. To listen to the recording, select  (*Play*) and push the navigation pad.
9. To delete the recording, select  (*Delete*) and push the navigation pad.
10. When completed, select  (*Done*) and push the navigation pad.

15.5 Adding a sketch

You can add a freehand drawing to an infrared image.

Follow this procedure:

1. Open the image in the image archive.
2. Push the navigation pad to display the top toolbar.
3. On the top toolbar, select the  icon and push the navigation pad.
4. On the right toolbar, select the  icon and push the navigation pad.
5. You are now in sketch mode. Draw the sketch by touching the screen.



6. (Optional step.) Push the navigation pad. This displays a context menu. Do one or more of the following:
- To change the color of the sketch tools, select  (*Draw*) and push the navigation pad. Select the color and push the navigation pad.
 - To erase, select  (*Eraser*) and push the navigation pad. Erase parts of the sketch by touching the screen.
 - To add an arrow, circle, or cross, select  (*Stamp sketch*) and push the navigation pad. Select the type of stamp and push the navigation pad. The stamp is displayed in the center of the screen. You can move the stamp by using the navigation pad or by touching the screen. When completed, push the navigation pad.
 - To clear, select  (*Clear all*) and push the navigation pad.
 - When the sketch is completed, select  (*Save*) and push the navigation pad.

Programming the camera (time-lapse)

Note The availability of this feature is dependent on the camera model.

You can program the camera to save images periodically (time-lapse).

Follow this procedure:

1. Push the navigation pad to display the menu system.
 2. Select  (*Settings*) and push the navigation pad. This displays the *Settings* menu.
 3. Use the navigation pad to select *Recording mode > Time-lapse*.
 4. Push the navigation pad. This displays a dialog box where you can set the save conditions:
 - *Save interval*: Use the navigation pad to set the time interval between each saved image.
 - *Total number of images*: Periodic saving will stop when the set number of images have been saved.
- Note** If you select “∞,” the camera will keep on saving images until the memory card is full or until you manually stop the time-lapse.
5. Push the navigation pad. This closes the dialog box.
 6. Push the back button  repeatedly to exit the *Settings* menu.
 7. The time interval is displayed at the top of the screen.
 8. To start the time-lapse (periodic saving), pull and release the trigger.
 9. To manually stop the time-lapse, pull and release the trigger.
 10. When the time-lapse is completed, an information screen is displayed. Push any button or touch the screen to return to the live image.



17.1 General

You can record and save video clips to the memory card.



Note The camera can be configured to save video in *.mpg or *.csq format. Select  (*Settings*) > *Save options & storage* > *Video compression*.

- *Mpeg (*.mpg)*: Mpeg recordings cannot be edited after the file has been saved.
- *Radiometric storage (*.csq)*⁸: A *.csq file supports full radiometry but is only supported by FLIR Systems software. The file does not include any visual image information. With this setting, only *Thermal* image mode is supported when recording video. If any other image mode is active when *Video* recording mode is selected, the camera will auto-switch to *Thermal* image mode.

17.2 Recording a video clip

1. Push the navigation pad to display the menu system.
2. Select  (*Settings*) and push the navigation pad. This displays the *Settings* menu.
3. Use the navigation pad to select *Recording mode* > *Video*.
4. Push the back button  to exit the *Settings* menu.
5. To start a recording, pull and release the trigger. A counter at the top of the screen displays the duration of the recording.
6. To stop a recording, pull and release the trigger. The recording is automatically saved to the image archive.

17.3 Playing a saved video clip

1. Push the image archive button . This displays the *Gallery* with one or more folders.
2. Select a folder and push the navigation pad.
3. Select the video clip you want to play and push the navigation pad.
4. Push the navigation pad to display the top toolbar.
5. On the top toolbar, select the  icon and push the navigation pad.
6. To play or pause the video clip, push the navigation pad.

8. The availability of this format is dependent on the camera model.

18.1 General

FLIR Inspection Route is a solution that streamlines thermal inspections and simplifies data collection and reporting. The solution includes FLIR software and camera support for preparation, inspection, and post-processing.

With the Inspection Route function, the camera guides the operator along a predefined route of inspection points, where images and data are collected in a structured manner. FLIR Inspection Route speeds up post-processing and reporting by ensuring that nothing is missed and that all inspection results are organized right from the start.

The inspection work flow is defined by a Route file, with a high degree of flexibility. It is possible to configure an automated work flow, where the camera automatically sets the status and steps to the next inspection point when an image is saved. The operator can also manually select the status, add comments, and add more images.

The Route file is used as template when starting an inspection in the camera. It is possible to have multiple Route files in camera and the operator can run multiple inspections based on any of the Route files in the camera.

Reference images provide aiming support, increase quality in decision making in the field, and speeds up data collection by defining a baseline for the user based on a set of predefined parameters.

18.1.1 Work flow

The work flow typically involves the following steps:

1. Prepare one or more Route files, using one of the following methods:
 - The FLIR Thermal Studio application.
 - Your own solution. The FLIR Thermal SDK can be used to build your own export/import software or to interface your existing asset management system.
2. Add the Route file(s) to the camera memory card.
3. Perform one or more inspections based on the Route files available on the memory card.
4. Move the inspection results from the camera using the USB cable or the memory card, or upload the results to FLIR Ignite.
5. Import the results into FLIR Thermal Studio or your own image management and reporting system.
6. Create an inspection report.

18.1.2 FLIR Inspection Route Solution user manual

The FLIR Inspection Route Solution user manual describes how to configure Route files, perform inspections, transfer inspection results, and create inspection reports using a camera with FLIR Inspection Route enabled, the FLIR Thermal Studio application, and the FLIR Ignite cloud service.

To access the FLIR Inspection Route Solution user manual, go to <http://support.flir.com/resources/route>.

18.1.3 First generation FLIR Inspection Route

The first generation of the Inspection Route functionality in the camera was based on an inspection route file in .xml format. The new Inspection Route functionality is based on a Route file in .routex format.

The camera still supports the xml based functionality. However, it is not possible to use a mix of .xml and .routex files on the camera memory card.

If there is an inspection route file (.xml) at the root of the memory card, the camera will start an inspection based on the .xml file when you activate the Inspection Route functionality.

18.1.3.1 User manual

For a description of the xml based FLIR Inspection Route functionality, refer to the user manual for the FLIR Inspection Route Solution, First generation.

To access the user manual, go to <http://support.flir.com/resources/route>.

18.2 Route file

The Route file specifies the structure, consisting of multiple levels of locations, assets, and inspection points. The Route file also specifies the available statuses and the configuration of the camera behavior and includes any reference images.

You can create the Route files in FLIR Thermal Studio.

The Route files must be placed in a folder named *Routes* located at the root of the camera memory card.

18.3 Inspection file

You can start a new inspection based on any of the Route files available in the *Routes* folder on the camera memory card.

During the inspection, the camera stores the inspection results internally. When you pause, finish, upload, or deactivate the Inspection Route function, the camera creates a package — an Inspection file (.route) — that includes all the inspection data (status, comments) and images for each inspection point.

The camera stores the Inspection file (.route) in a folder named *Inspections* located at the root of the memory card.

18.4 User interface



The Inspection Route overlay consists of the following parts:

- Back arrow
 - Tap to go to the previous inspection point.
- Current point indicator
 - Displays the name of the current inspection point.
 - Displays an image icon if there is an image saved for the inspection point.
 - Displays the status of the inspection point.
- Next arrow
 - Tap to go to the next inspection point.

- Document icon
This icon is displayed if there is a description and/or comment available for the inspection point. A description comes from the Route file and can, for example, include instructions or reminders for the inspection point. Comments are text notes added during the inspection. Tap the icon to display the description and/or comment.
- Reference image

18.4.1 Reference image

You can use the reference image for aiming support. It is possible to switch between the infrared and visual reference image.

When maximized, the reference image covers the entire screen.

With the Overlay functionality enabled, the reference image is transparent and is displayed over the live image.



1. Tap to show or hide the reference image.
2. Tap to switch between the infrared and visual reference images.
3. Tap to enable or disable the Overlay functionality. When enabled, the reference image is transparent.
4. Tap to maximize or minimize the reference image.

18.4.2 Drop-down menu

To display the drop-down menu, tap the current point indicator.

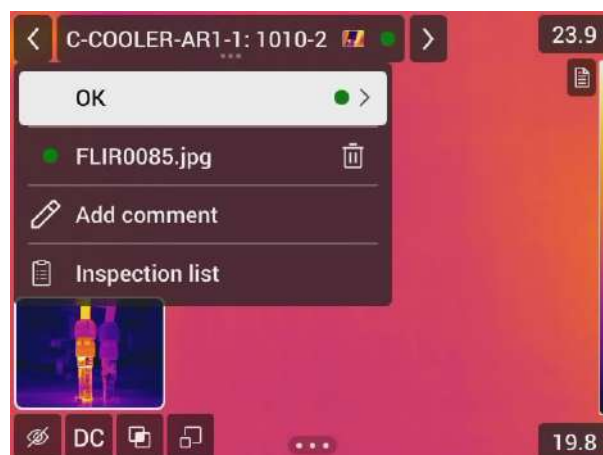

In the drop-down menu it is possible to:

- Set the status of the current inspection point.
- View the filenames of images saved for this inspection point.
- Add comments for the current inspection point.

-
- Open the inspection list, see section 18.5.8 *Inspection list*.

18.5 Perform inspection

This procedure assumes that one or more Route files (.routex) have been created.

18.5.1 General

To perform an inspection, you first have to add one or more Route files to the camera memory card. The Route files must be placed in a folder named *Routes* located at the root of the camera memory card. See also section 18.2 *Route file*.

You can start a new inspection based on any of the Route files available on the camera memory card. During the inspection, the camera stores the inspection results internally. When the inspection is completed, the camera creates an Inspection file with the inspection results and stores the file in a folder named *Inspections* located at the root of the memory card. See also section 18.3 *Inspection file*.

When uploading the inspection results to FLIR Ignite, the camera uploads the Inspection file (.route) to your FLIR Ignite account. Uploading the Inspection file (.route) does not remove the file from the *Inspections* folder located at the root of the memory card.

18.5.2 Add the Route file to the memory card

Note

- You can add multiple Route files (.routex) to the memory card.
- The Route files must be placed in a folder named *Routes* located at the root of the camera memory card.
- Make sure there is no old inspection route file (xml) at the root of the camera memory card. See also section 18.1.3 *First generation FLIR Inspection Route*.

To add the Route file to the memory card, do the following:

1. Connect the camera to the computer with a USB cable or insert the memory card into the computer.
2. Check the root of the memory card. If no *Routes* folder exists, you must create a folder named *Routes* at the root of the memory card.
3. Add the Route file (.routex) to the *Routes* folder.
4. Disconnect the USB cable or insert the memory card into the camera.

18.5.3 Inspection settings

18.5.3.1 Route file settings

The behavior of the camera during the inspection is controlled via settings in the Route file. It is also possible to define these settings in the camera, see section 18.6 *Configuration*.

To use the settings from the Route file, select *Settings > Routing > Inspection settings > Use Route settings = On*.

18.5.3.2 Reference image settings

The camera can be configured to use the settings and parameters from the reference image. For more information, see section 18.7 *Use settings and parameters from reference images*.

To use the settings and parameters from the reference images, select *Settings > Routing > Inspection settings > Reference image > Apply parameters = On*.

18.5.4 Start an inspection

1. Activate the Inspection Route function by selecting *Settings > Routing > Inspection Route = On*.

2. Select *Routes*. This displays a list of the available Routes in the camera.
3. Select one of the Routes.
4. Select *Start Inspection*.

18.5.5 Capture inspection data

1. The live image displays the name of the inspection point to inspect (current point indicator).
If there is a reference image, tap the icons to switch between the infrared and visual reference images, change the size, and make the reference image transparent.
To view a description of the inspection point, e.g., instructions or reminders, tap the document icon.

Note The document icon is only displayed if there is a description and/or comment available for the inspection point.



2. When the camera is in the right position, take an image. The camera automatically saves the image.
Note Depending on the inspection settings, the camera may automatically set the default status and/or continue to the next inspection point after saving an image.
3. To edit the inspection point data, tap the current point indicator. This displays a drop-down menu where you can change the status, add a comment, and delete the image.
Note Make sure the current point indicator displays the inspection point you want to edit. If not, use the back or next arrow.
4. Tap the next arrow to continue to the next inspection point.
5. Continue the inspection until you have completed all inspection points.
Note You can open the inspection list to see the progress of the inspection and make any additional changes. To open the inspection list, tap the current point indicator and select *Inspection list*.
6. When you have completed the inspection, select *Settings > Routing > Inspections*. Select your inspection and then select *Finish*.
7. The camera now creates an Inspection file (.route) with the inspection data and images and stores the file in the *Inspections* folder located at the root of the memory card. See also section 18.3 *Inspection file*.

Note

- You can turn off the camera in the middle of an inspection. The camera will always save all data. When the camera is turned on again, it will display the first uncompleted inspection point.
- You can pause the ongoing inspection and start another inspection. You can at any time resume an inspection and continue from the first uncompleted inspection point.
- While an inspection is ongoing, the camera stores the inspection results internally. The camera does not add the inspection results to the Inspection file (.route) until after you have paused, finished, uploaded, or deactivated the Inspection Route function.

18.5.6 Save an image

When you take an image, the camera automatically saves the image to the memory card.

You can take and save multiple images of the inspection point.

Note For every new image, make sure that the current point indicator displays the inspection point you want to add the image to. If not, use the back or next arrow or select the inspection point from the inspection list, see section 18.5.8 *Inspection list*.

18.5.7 Inspection images

During the inspection, the camera saves the inspection images to the memory card. While an inspection is ongoing, the images are also available in the image archive.

When you pause, finish, upload, or deactivate the Inspection Route function, the camera adds all inspection images to the Inspection file (.route) and the images are no longer available in the image archive. You can always open an Inspection from the *Settings* menu and view the images via the Inspection list, see section 18.5.8 *Inspection list*.

18.5.8 Inspection list

In the inspection list, you can see the progress of the inspection and review the inspection point results.

The content of the inspection list is defined by the Route file. The route structure and names come from the file.

To see the progress and review the results, do the following:

1. Tap the current point indicator. This displays a drop-down menu.
2. Tap *Inspection list*. This displays a list with all inspection routes and their progress.
3. Tap an item in the list to display the next level in the inspection route structure.
4. When you reach a level with inspection points, you can see their status and if they have any images associated.
5. To make changes to an inspection point, tap the inspection point in the list. This takes you to the live view for that inspection point.

18.5.9 Edit inspection point data

You can edit the data for the inspection point displayed by the current point indicator.

To go to another inspection point, use the back or next arrow or select the inspection point from the inspection list, see section 18.5.8 *Inspection list*.

18.5.9.1 Set the status

1. Tap the current point indicator. This displays a drop-down menu.
2. Tap the status you want to set. The set status is indicated by a check mark in the menu and by a color in the current point indicator.

Note

- The available statuses are defined by the Route file.
- Depending on the configuration, it may be necessary to take an image before a status can be set.

18.5.9.2 Delete an image

1. Tap the current point indicator. This displays a drop-down menu.
2. Tap  to delete the image. This displays a window.
3. To delete the image, tap *Delete*.

18.5.9.3 Add a comment

1. Tap the current point indicator. This displays a drop-down menu.
2. Tap *Add comment*. This displays a soft keyboard.
3. Enter text by touching the screen.
4. When completed, tap *Done*.
5. The comment is displayed in the drop-down menu. You can also see the comment by tapping the document icon.

18.5.10 Record a video clip

You can record and save video clips of the inspection point. For more information, see section 17 *Recording video clips*.

Note Make sure that the current point indicator displays the inspection point you want to add the video to. If not, use the back or next arrow or select the inspection point from the inspection list, see section 18.5.8 *Inspection list*.

18.5.11 Transfer inspection results

You can upload the inspection results to your FLIR Ignite account or transfer the result files manually using the USB cable or the memory card.

18.5.11.1 Upload results to FLIR Ignite

1. Make sure the camera is connected to the internet.
2. Make sure the camera is paired with your FLIR Ignite account.
3. Select *Settings > Routing > Inspections*.
4. Select the inspection to upload.
5. Select *Upload to Ignite*.
6. The camera now uploads the Inspection file (.route) to your FLIR Ignite account. The Inspection file (.route) includes the inspection data and images.
If the inspection is ongoing, the camera first creates and adds the inspection data and images to the Inspection file (.route) and then uploads the file. When the upload is completed, you can continue the inspection.

Note Uploading the Inspection file (.route) will not remove the file from the *Inspections* folder located at the root of the memory card.

18.5.11.2 Move results manually

1. Connect the camera to the computer with a USB cable or insert the memory card into the computer.
2. Go to the folder named *Inspections* located at the root of the memory card.
3. Save the Inspection file (.route) to the computer.

Note You can also open the Inspection file on the memory card directly from FLIR Thermal Studio.

18.6 Configuration

The behavior of the camera during the inspection is controlled via settings in the Route file. It is possible to override the Route settings and define the settings in the camera.

To define the camera behavior settings in the camera, do the following:

1. Select *Settings > Routing > Inspection settings > Use Route settings = Off*.

2. Camera behavior settings:

- *Auto next*: This setting defines if the camera after saving an image automatically will set the default status and step to the next inspection point. If most inspection points will have the default status, you will save inspection time by enabling the setting. If you often want to set the status or add comments to the inspection points, it may be more convenient to disable the setting.
- *Default status*: This submenu is used to select the status to be set when an image is saved. The options in the submenu come from the Route file.
- *Require image*: This setting defines if the operator must save an image before it is possible to set the status of an inspection point.
- *Delete empty inspection points*: This setting defines if all empty inspection points (no image and no status) will be removed from the Inspection file when the inspection is finished.

18.7 Use settings and parameters from reference images

The camera can be configured to use the settings and parameters from the reference images. At each inspection point, the camera will automatically apply the same measurement tools, measurement parameters (e.g. emissivity, reflected temperature, etc.), temperature scale values, and color palette as in the reference image.

To apply the settings and parameters from the reference images, do the following:

1. Select *Settings > Routing > Inspection settings > Reference image*.
2. To apply the parameter settings from each Reference image, select *Apply parameters = On*.
3. To select what parameters to apply, select *Select parameters*.

The screening alarm can be used to detect temperature anomalies in a series of inspected objects in a similar/fixed setup.

19.1 General

The basics of the screening alarm is to first build up a base of reference temperature samples. When an object is screened, the camera compares the measured temperature with the average of the reference samples. If the camera detects a temperature that is above a specified threshold, an alarm will trigger.

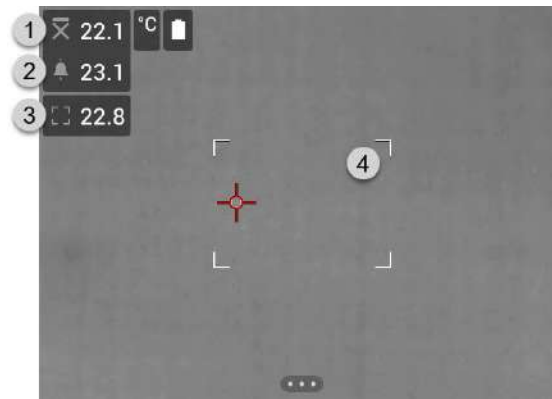

1. Sampled average temperature.
2. Alarm limit.
3. Measured temperature.
4. Measurement box.

The camera detects and measures the temperature of the hottest spot within the measurement box.

An alarm will trigger when the measured temperature is higher than the alarm limit. The camera will also apply a red color to all parts of the image with a temperature above the alarm limit.

The alarm limit is the sum of a sampled average temperature and a specified allowed deviation.

19.2 Work flow

The screening work flow involves the following steps:

1. Activate and configure the screening alarm.
2. Record reference samples.
3. Perform the screening.
4. Record new samples to keep the sampled average up to date.

19.2.1 Activate and configure the screening alarm

1. Activate the screening alarm by selecting  (*Settings*) > *Recording mode* > *Screening*.
2. In the *Screening* dialog box, you can define the settings for the alarm:
 - *Allowed deviation*: The allowed deviation from the sampled average.
 - *Alarm sound*: Beep or no sound when the alarm triggers.

19.2.2 Record reference samples

Before the screening can start, you must record reference samples. These are used to calculate the reference temperature average.

You record the reference samples by screening 10 inspection objects. Make sure these objects have a normal temperature.

1. Aim the camera toward an inspection object with a normal temperature. The object should be within the frame of the measurement box.
2. Adjust the camera focus.

Note It is important to adjust the focus correctly. Incorrect focus adjustment affects the temperature measurement.

3. To record a sample, push the programmable button.

Note Push the programmable button shortly. If you push and hold the button, the sampled average will be reset.

4. Repeat the steps above until 10 samples have been recorded.

19.2.3 Perform the screening

1. Aim the camera toward an inspection object. The object should be within the frame of the measurement box.
2. Adjust the camera focus.

Note It is important to adjust the focus correctly. Incorrect focus adjustment affects the temperature measurement.

3. The camera measures and evaluates the temperature. If the temperature is higher than the alarm limit, an alarm will trigger. The camera will apply a red color to all parts of the image with a temperature above the alarm limit.

4. Optionally: Record a new sample.
Push the programmable button.

Note Push the programmable button shortly. If you push and hold the button, the sampled average will be reset.

Note Every time you push the programmable button, a sample is recorded. If you happen to record a sample when the camera is not aiming at an inspection object, you must reset the sampled average and record 10 new samples. To reset the sampled average, push and hold the programmable button.

Depending on your camera configuration, you can connect the camera to a wireless local area network (WLAN) using Wi-Fi, or let the camera provide Wi-Fi access to other devices.

You can connect the camera in two different ways:

- Setting up the camera as a wireless access point. This method is primarily used with other devices, e.g., an iPhone or iPad.
- Connecting the camera to a Wi-Fi network.

The Wi-Fi functionality is managed from the *Settings* menu. You can also enable/disable Wi-Fi on the swipe-down menu. For more information, see section 6.4.4 *Swipe-down menu*.

20.1 Setting up a wireless access point

1. Push the navigation pad to display the menu system.
2. Select  (*Settings*) and push the navigation pad. This displays the *Settings* menu.
3. Use the navigation pad to select *Connections > Wi-Fi*.
4. Select *Share* and push the navigation pad.
5. (Optional step.) To display and change the parameters, select *Share settings* and push the navigation pad.
 - To change the SSID, select *Network name (SSID)* and push the navigation pad.
 - To change the WPA2 password, select *Password* and push the navigation pad.

Note These parameters are set for your camera's network. They will be used by the external device to connect that device to the network.

- Toggle the switch to enable/disable the firewall for the network shared by the camera.

Note To enable/disable the camera firewall, select *Connections > Advanced > Global firewall*.

20.2 Connecting the camera to Wi-Fi

1. Push the navigation pad to display the menu system.
2. Select  (*Settings*) and push the navigation pad. This displays the *Settings* menu.
3. Use the navigation pad to select *Connections > Wi-Fi*.
4. Select *Connect to network* and push the navigation pad.
5. To display a list of the available networks, select *Available networks* and push the navigation pad.
6. Select one of the available networks and push the navigation pad.

Note Password-protected networks are indicated with a padlock icon, and for these you will need to enter a password the first time you connect to the network. After that the camera will connect automatically to the network. To disable the automatic connection, select *Forget network*.

Note Some networks do not broadcast their existence. They appear in the list as *Untitled*. To connect to such a network, you will be prompted to enter additional parameters.

Note To enable/disable the camera firewall, select *Connections > Advanced > Global firewall*.

You can use the camera with the following Bluetooth devices:

- METERLiNK devices (FLIR meters).
- Bluetooth-enabled headsets.

If supported by your mobile phone, you can also share the phone's internet connection with the camera via Bluetooth.

Note The Bluetooth protocol is limited in terms of data transfer and best suited for upload of single images. For upload of videos and folders with several images, it is recommended to use Wi-Fi.

Before you can use a Bluetooth device with the camera, you need to pair the devices. The Bluetooth functionality is managed from the *Settings* menu. You can also enable/disable Bluetooth on the swipe-down menu. For more information, see section 6.4.4 *Swipe-down menu*.

Follow this procedure:

1. Push the navigation pad to display the menu system.
2. Select  (*Settings*) and push the navigation pad. This displays the *Settings* menu.
3. Use the navigation pad to select *Connections > Bluetooth*.
4. Make sure Bluetooth is enabled by toggling the *Bluetooth* switch.

Note You also need to ensure that the external Bluetooth device is in visible mode. On the mobile phone, you must make sure that Bluetooth is enabled, that the phone is in discovery mode, and that Bluetooth tethering is enabled.

5. Select *Available devices* and push the navigation pad.
6. Wait until a list of available Bluetooth devices is displayed.
7. When a Bluetooth device is found, select the device to add it, and begin the pairing procedure. The device is then ready to be used.

Note

- You can add several devices.
- You can remove a device by selecting the device and then selecting *Unpair device*.
- After adding a METERLiNK device, such as the FLIR MR77 or FLIR DM93, the result from the meter will be visible in the result table and stored with the images. For more information, see section 22 *Fetching data from external FLIR meters*.
- After adding a Bluetooth-enabled headset, it is ready to be used for adding voice annotations.

Fetching data from external FLIR meters

22.1 General

You can fetch data from some external FLIR meters that support Bluetooth and merge this data into the infrared image. When the camera is connected to a FLIR meter via Bluetooth, the measurement value from the meter is displayed in the result table of the camera. The FLIR meter value is also added to the information saved in the image file.

In preview mode and when editing an image in the archive, you can add more than one value from the same FLIR meter. The last added value is displayed below the previous values. The live value is displayed with a dotted outline.

If the screen display for values is full, it is still possible to add more values from the FLIR meter. Added values are then indicated by a box with a number that counts up each time a new value is added.

To find out whether a FLIR meter is supported by the camera, consult the meter documentation.

22.2 Technical support for external meters

Technical support	
Website	http://support.flir.com

22.3 Procedure

Note

- Before you can use a FLIR meter with the camera, you need to pair the devices. For more information, see section 21 *Pairing Bluetooth devices*.
- To add more than one FLIR meter value when saving an image, preview mode must be enabled. Select  (Settings) > Save options and storage > Preview image before saving = On.

Follow this procedure:

1. Turn on the camera.
2. Turn on the FLIR meter.
3. On the FLIR meter, enable Bluetooth mode. Refer to the user documentation for the meter for information on how to do this.
4. On the FLIR meter, choose the quantity that you want to use (voltage, current, resistance, etc.). Refer to the user documentation for the meter for information on how to do this.

Results from the meter will now automatically be displayed in the result table in the top left corner of the infrared camera screen.

5. On the camera, in preview mode and when editing an image in the archive, you can do the following:
 - Push the programmable button to add the value currently displayed by the FLIR meter.
 - Push and hold the programmable button to remove all FLIR meter values from the image.

Note Any function assigned to the programmable button is temporarily disabled when in preview mode or when editing an image in the archive.

22.4 Typical moisture measurement and documentation procedure

The following procedure can form the basis for other procedures using FLIR meters and infrared cameras.

1. Use the infrared camera to identify any potential damp areas behind walls and ceilings.
2. Use the moisture meter to measure the moisture levels at various suspect locations that may have been found.
3. When an area of particular interest is located, store the moisture reading in the moisture meter's memory and identify the measurement area with a handprint or other thermal identifying marker.
4. Recall the reading from the meter memory. The moisture meter will now continuously transmit this reading to the infrared camera.
5. Use the camera to take a thermal image of the area with the identifying marker. The stored data from the moisture meter will also be saved on the image.

22.5 More information

For more information, see the user manuals that are shipped with FLIR meters.

The *Settings* menu includes the following:

- *FLIR Ignite*.
- *Recording mode*.
- *Connections*.
- *Camera temperature range*.
- *Save options & storage*.
- *Device settings*.

23.1 FLIR Ignite

Select FLIR Ignite and follow the on-screen instructions to sign in to your FLIR Ignite account.

After sign in, the following is displayed:

- The FLIR Ignite user account that the camera is paired with.
- The amount of used and available storage space on the FLIR Ignite account.
- *Auto upload* switch: Toggle to enable/disable automatic upload of images.

For more information about FLIR Ignite and online storage of images, see section 9 *Cloud connectivity*.

23.2 Recording mode

The *Recording mode* is used to select:

- *Single shot*: This setting enables single shot mode. In this mode, you save an image by pulling the trigger.
- *Video*: This setting enables video recording mode. For more information, see section 17 *Recording video clips*.
- *Time-lapse*: This setting enables time-lapse mode. For more information, see section 16 *Programming the camera (time-lapse)*.
- *Screening*: This setting enables screening mode. For more information, see section 19 *Screening alarm*.

23.3 Connections

- *Wi-Fi*: This setting defines Wi-Fi networks. For more information, see section 20 *Configuring Wi-Fi*.
 - *Off*: This setting is used to disable Wi-Fi.
 - *Share*: This setting is used to set up the camera as a wireless access point.
 - *Connect to network*: This setting is used to connect the camera to a Wi-Fi network.
- *Bluetooth*: This setting defines Bluetooth connectivity. For more information, see section 21 *Pairing Bluetooth devices*.
- *Advanced*: This submenu includes the following settings:
 - *Global firewall*: This setting is used to enable/disable the camera firewall.

Note

- It is recommended to keep the camera firewall enabled. Only disable the firewall when experiencing problems connecting to legacy applications.
- To enable/disable the firewall for a shared network, see section 20.1 *Setting up a wireless access point*.

- *Trusted connections*: List of trusted applications (which can make connections to the camera).

23.4 Camera temperature range

For accurate temperature measurements, you must change the *Camera temperature range* setting to suit the expected temperature of the object you are inspecting.

Available temperature range options are dependent on the camera model. The unit (°C or °F) depends on the temperature unit setting, see section 23.6 *Device settings*.

23.5 Save options & storage

- *Inspection route*⁹: This setting is used to activate and configure the Inspection Route function. For more information, see section 18 *Inspection Route*.
- *Preview image before saving*: This setting defines if a preview image will be displayed before the image is saved.
- *Add annotation after saving*: This setting defines if an annotation tool will be displayed when the image has been saved. Available options are:
 - *Save*: No annotation tool will be displayed.
 - *Save & add note*: The note annotation tool will be displayed.
 - *Save & add table*: The table annotation tool will be displayed.
 - *Save & add voice annotation*: The voice annotation tool will be displayed.
 - *Save & add sketch*: The sketch annotation tool will be displayed.
 - *Save & add any annotation*: The annotation tool menu will be displayed.
- *Image resolution*¹⁰: This setting defines the resolution of the images captured by the camera. Available options are *Normal* and *UltraMax*. For more information, see section 8.1.4 *About UltraMax*.
- *Video compression*: This setting defines the storage format for video clips. Available options are:
 - *Mpeg (*.mpeg)*: MPEG recordings cannot be edited after the file has been saved.
 - *Radiometric storage (*.csq)*¹¹: A CSQ file supports full radiometry but is only supported by FLIR Systems software. The file does not include any visual image information. With this setting, only *Thermal* image mode is supported when recording video.
- *Video frame rate*: This setting is used to select the frame rate for video recordings.
- *Video microphone*: This setting is used to turn on/off the microphone.
- *Photo as separate JPEG*: For the *Thermal MSX*, *Thermal*, and *Picture in picture* image modes, a visual image is always saved in the same JPEG file as the thermal image. Enabling this setting saves an extra low-resolution visual image as a separate JPEG file.
- *Digital camera*: This setting is used to turn on/off the digital camera. Turning off the digital camera can for example be required in restricted areas and in confidential (e.g. doctor/patient) situations. When the digital camera is off, the images modes *Thermal MSX* and *Picture in picture* are disabled.
- *Measure distance*¹²: This setting defines if the laser distance meter will be used to measure the distance when an image is saved. With this setting, the *Object distance* parameter (see section 13.5 *Changing the measurement parameters*) in the image data is automatically updated with the measured distance when an image is saved. (There is no effect on the *Object distance* setting in live mode.)
- *File naming format*: This setting defines the naming format for new image/video files. The setting has no impact on already saved files in the archive. Available options are:
 - *DCF*: DCF (Design rule for Camera File system) is a standard that specifies the naming method of image files (and much more). With this setting, the name of a saved image/video file will be FLIRxxxx, where xxxx is an incremental counter.

9. This item is dependent on the camera model.

10. This item is dependent on the camera model.

11. This item is dependent on the camera model.

12. This item is dependent on the camera model.

Example: FLIR0001. (When the counter has reached 9999, the file name will change to IR_yyyyy.jpg.)

- *Date prefix*: A prefix will be added to the filename, including the date and the text “IR_” for images and “MOV_” for videos. Examples: IR_2015-04-22_0002 and MOV_2015-04-22_0003. The date format will follow the *Date & time format* setting, see section 23.6 *Device settings*.
- *Date + time only*: The filename will only include the date and time of capture (YYYYMMDDhhmmssff).

Note With the *Date prefix* and *Date + time only* settings, the files may not automatically be detected by third-party applications.

- *Delete all saved files...*: This displays a dialog box where you can choose to permanently delete all the saved files (images and videos) from the memory card or to cancel the delete action.

23.6 Device settings

- *Language, time & units*: This submenu includes settings for a number of regional parameters:
 - *Language*.
 - *Temperature unit*.
 - *Distance unit*.
 - *Time zone*.
 - *Date & time*.
- *Focus*¹³: This submenu includes the following settings:
 - *Autofocus*: When autofocusing, the infrared camera can use one of the following focus methods:
 - *Contrast*: The focus is based on maximizing the image contrast.
 - *Laser*: The focus is based on a laser distance measurement. The laser is on when the camera is autofocusing.
 - *Continuous autofocus*: This setting is used to enable/disable continuous autofocus.
- *Display settings*: This submenu includes the following settings:
 - *Screen rotation*: This setting defines if the orientation of the overlay graphics will change according to how you hold the camera.
 - *Image overlay information*: This setting specifies what image information the camera will display as an overlay on the image. For more information, see section 6.4.5 *Image overlay information*. You can select the following information to display:
 - *Compass*.
 - *Date & time*.
 - *Emissivity*.
 - *Reflected temperature*.
 - *Distance*.
 - *Relative humidity*.
 - *Atmospheric temperature*.

Note This setting only specifies what information to overlay on the image. All image information is always saved to the image file and is available in the image archive.

- *Screen brightness*: The screen brightness slider is used to control the brightness of the screen.

Note You can also control the screen brightness on the swipe-down menu. For more information, see section 6.4.4 *Swipe-down menu*.

13. This item is dependent on the camera model.

-
- *Update*: Check for updates and install new firmware versions. The camera must be connected to the internet. See also section 25 *Updating the camera*.
 - *Geolocation*: This submenu includes the following settings:
 - *GPS*: This setting is used to enable/disable the GPS.
 - *Compass*: This setting is used to enable/disable the compass and to calibrate the compass. For more information, see section 7.17 *Calibrating the compass*.
 - *Lamp & laser*: This submenu includes the following settings:
 - *Enable lamp & laser*: This setting is used to enable the camera lamp and the laser.
 - *Enable lamp & laser + Use lamp as flash*: This setting is used to enable the flash function. When the flash function is enabled, the camera lamp will flash when an image is saved.
 - *Disable all*: This setting is used to disable the camera lamp, laser, and flash function.
 - *Auto power off*: This setting defines how soon the camera is automatically turned off.
 - *User interface options*: This submenu includes the following settings:
 - *Auto adjustment method*: This setting is used to select the color distribution method for the automatic image adjustment mode. For more information, see section 11.3 *Adjusting the infrared image*.
 - *Histogram*: The colors are distributed based on the thermal content of the image.
 - *Linear*: The colors are distributed evenly from the lowest to the highest temperature.
 - *Auto adjustment region*: This setting is used to set the region used for auto image adjustment. For more information, see section 11.3 *Adjusting the infrared image*.
 - *Manual adjustment using touch*: This setting is used to enable/disable the touch functionality for manual image adjustments. For more information, see section 11.3 *Adjusting the infrared image*.
 - *Manual adjustment mode*: This setting specifies the type of manual image adjustment mode. Available options are *Level, Max, Min* and *Level, Span*. For more information, see section 11.3 *Adjusting the infrared image*.
 - *Emissivity mode*: This setting specifies how the measurement parameter emissivity will be entered. Available options are *Select values* and *Select from materials table*. For more information, see section 11.6 *Changing the measurement parameters*.
 - *Color theme*: This setting is used to select *Light* or *Dark* color user interface theme.
 - *Volume*: This submenu is used to control the volume of the built-in speaker.
 - *Reset options*: This submenu includes the following settings:
 - *Reset default camera mode...*: This setting will affect the image mode, color palette, measurement tools, and measurement parameters. Saved images will not be affected.
 - *Reset device settings to factory default...*: This setting will affect all camera settings, including regional settings. Saved images will not be affected. The camera will be restarted and you will be prompted to set the regional settings.
 - *Reset image counter...*: This setting will reset the numbering of the image file-names. To prevent image files being overwritten, the new counter value will be based on the highest existing filename number in the image archive.
- Note** When a reset option is selected, a dialog box is displayed with more information. You can choose to execute the reset action or to cancel.
- *Camera information*: This submenu displays information about the camera. No changes can be made.
 - *Model*.
 - *Serial number*.
 - *Part number*.
 - *Software*: The version of the software.
 - *FPGA*: The version of the FPGA firmware.

- *Storage*: The used and free space on the memory card.
- *Lens*: The field of view of the lens.
- *Battery*: The remaining battery capacity (in percent).
- *Calibration*¹⁴: This submenu displays lens–camera calibration information.
 - *Calibrate lens...*: This will start the lens–camera calibration wizard. For more information, see section 7.16 *Calibrating the lens–camera combination*.
- *Register camera...*: This will start the registration wizard. For more information, see section 3.2 *Register your camera*.
- *Licenses*: Open-source license information.
- *Regulatory*: Displays regulatory information about the camera. No changes can be made.

14. This item is dependent on the camera model.

24.1 Camera housing, cables, and other items

Use one of these liquids:

- Warm water
- A weak detergent solution

Equipment:

- A soft cloth

Follow this procedure:

1. Soak the cloth in the liquid.
2. Twist the cloth to remove excess liquid.
3. Clean the part with the cloth.



CAUTION

Do not apply solvents or similar liquids to the camera, the cables, or other items. This can cause damage.

24.2 Infrared lens

Use one of these liquids:

- A commercial lens cleaning liquid with more than 30% isopropyl alcohol.
- 96% ethyl alcohol (C₂H₅OH).

Equipment:

- Cotton wool



CAUTION

If you use a lens cleaning cloth it must be dry. Do not use a lens cleaning cloth with the liquids that are listed above. These liquids can cause material on the lens cleaning cloth to become loose. This material can have an unwanted effect on the surface of the lens.

Follow this procedure:

1. Soak the cotton wool in the liquid.
2. Twist the cotton wool to remove excess liquid.
3. Clean the lens one time only and discard the cotton wool.



WARNING

Make sure that you read all applicable MSDS (Material Safety Data Sheets) and warning labels on containers before you use a liquid: the liquids can be dangerous.



CAUTION

- Be careful when you clean the infrared lens. The lens has a delicate anti-reflective coating.
- Do not clean the infrared lens too vigorously. This can damage the anti-reflective coating.

24.3 Infrared detector

Even small amounts of dust on the infrared detector can result in major blemishes in the image. To remove any dust from the detector, follow the procedure below.

Note

- This section only applies to cameras where removing the lens exposes the infrared detector.
- In some cases the dust cannot be removed by following this procedure: the infrared detector must be cleaned mechanically. This mechanical cleaning must be carried out by an authorized service partner.

**CAUTION**

In Step 2 below, do not use pressurized air from pneumatic air circuits in a workshop, etc., as this air usually contains oil mist to lubricate pneumatic tools.

Follow this procedure:

1. Remove the lens from the camera.
2. Use pressurized air from a compressed air canister to blow off the dust.

To take advantage of our latest camera firmware, it is important that you keep your camera updated.

There are several ways to update the camera:

- When the camera is connected to the internet, the camera automatically searches for firmware updates. Via the *Settings* menu, you can download and install new firmware versions Over-The-Air (OTA) when they become available.
- Connect the camera to a computer with a USB cable and use the FLIR Camera Updater application to update the camera.
- Download an update package and update the camera manually. For more information, go to <https://support.flir.com>.

25.1 Prepare for update Over-The-Air (OTA)

Camera update Over-The-Air (OTA) is a new feature.

If your camera has an earlier firmware version, you must first manually update the camera to the latest version before your camera can be updated Over-The-Air (OTA).

For more information, go to <https://support.flir.com>.

To see which version is installed on your camera, select *Settings > Device settings > Camera information > Software*.

25.2 Update the camera Over-The-Air (OTA)

Note If a new firmware version is available, there will be a notification on the *Settings* menu.

To install a new firmware version, do the following:

1. Make sure the camera battery is fully charged.
2. Make sure the camera has Wi-Fi enabled and is connected to the internet.
3. Select *Settings > Device settings > Update*.
4. If an update is available, select *Download* to download the installation package.
5. Select *Install* to start the installation.
6. When the installation is completed, the camera will automatically restart.

25.3 Update via USB cable with the FLIR Camera Updater

The FLIR Camera Updater is a Windows application used to update the camera.

To update your camera, you must log in to your FLIR account or sign up for a new account. You must also register the camera.

25.3.1 Install the FLIR Camera Updater

1. Go to <https://support.flir.com>. Find the software download area and search for FLIR Camera Updater.
2. Download the FLIR Camera Updater installer package.
3. Start the installation by double-clicking the executable installer file.
4. Follow the instructions in the setup wizard.

25.3.2 Connect the camera

1. Connect the camera to the computer, using the USB cable.
2. Turn on the camera.
3. Run the FLIR Camera Updater application.

4. Sign in to your FLIR account or sign up for a new account.
5. The application automatically connects to the camera.
6. If the camera is not registered, select *Product registration* and complete the registration.
7. If a newer firmware version is available, you can select to update the connected camera.

25.3.3 Update notifications

The FLIR Camera Updater can send notifications if there is a new update available for your previously connected devices.

[See next page]

Exx incl. IR Lens std.

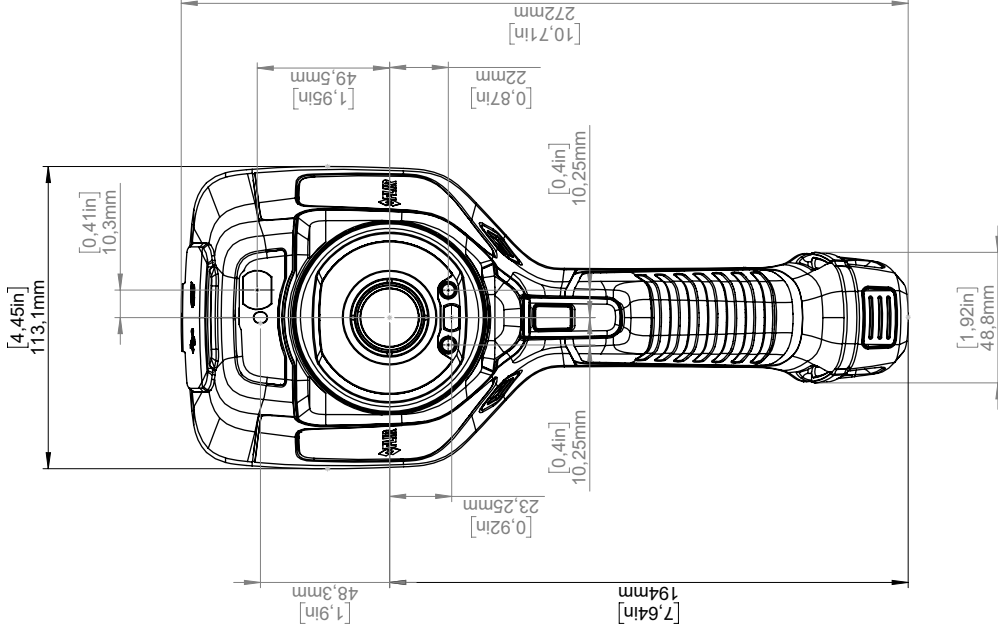
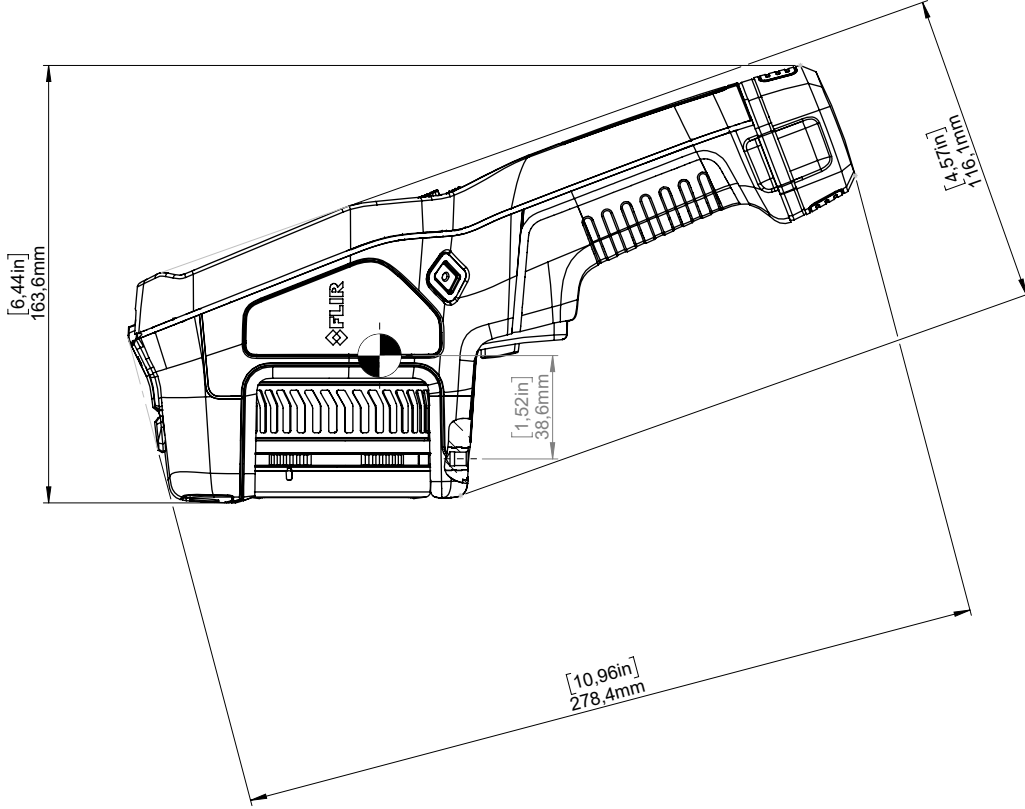
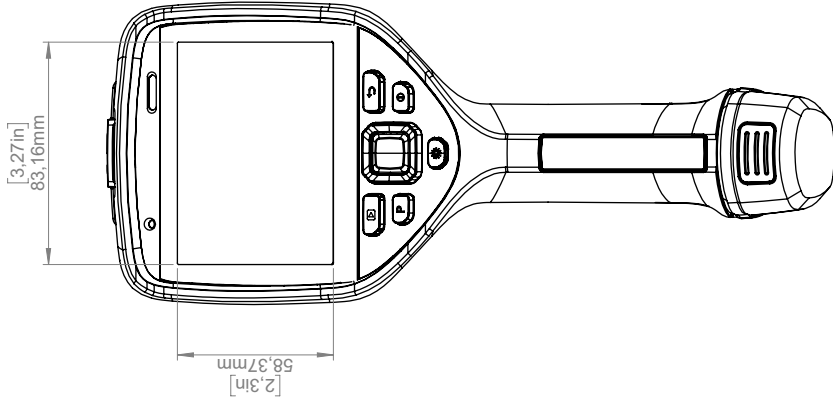

FLIR SYSTEMS AB
 Överträdelse härav bekräftar med stöd av gällande lag.
 sin helhet eller delar utan vårt medgivande.
 Denna handling får ej delges annan, kopieras!

FLIR SYSTEMS AB
 Any infringement will lead to legal proceedings.
 This document must not be communicated or
 copied completely or in part, without our permission.

Modified by A. AGARDSON	Approved by AKZE	Modified 2023-09-29	FLIR
This document does not contain any export-controlled information.			Size A3
Denomination Basic dimension drawing Exx			Scale 1:2
			Sheet 1(3)
			Rev T130127

A B C D E F G

1 2 3 4 5 6 7 8 9 10

A B C D E F G

1 2 3 4 5

Exx incl. IR Lens DFOV 17/29mm

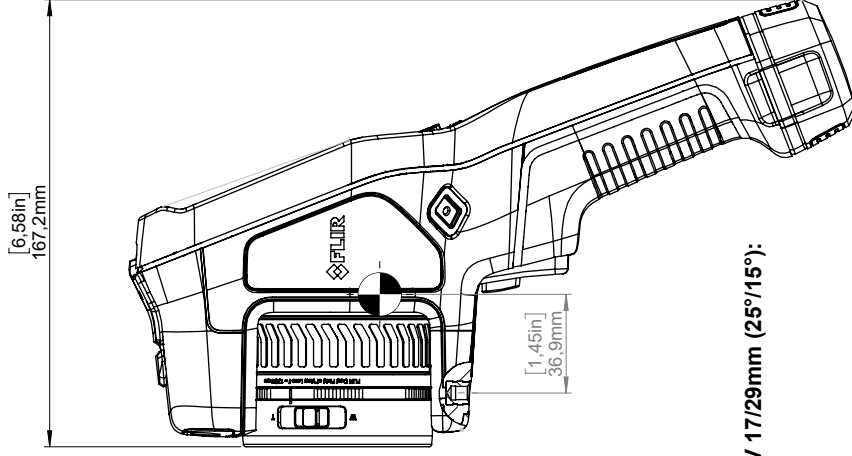

Weight including IR Lens DFOV 17/29mm (25°/15°):
approx. 1.16 kg

Modified by A. AGARDSON	Approved by AKZE	Modified 2023-09-29	FLIR
This document does not contain any export-controlled information.			Sheet 2(3)
Denomination Basic dimension drawing Exx			Rev E
Size A3	Scale 1:2	Drawing No T130127	

Exx incl. IR Lens 5mm

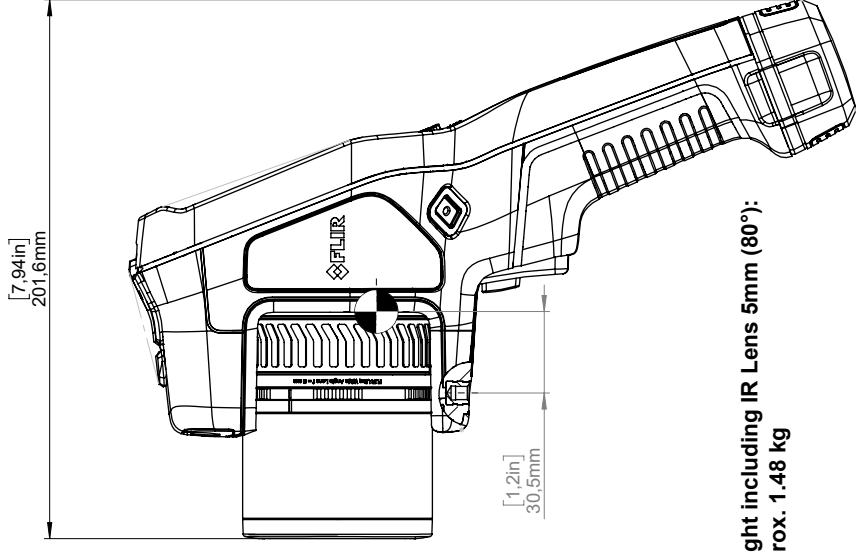

Weight including IR Lens 5mm (80°):
approx. 1.48 kg

Modified by A. AGARDSON	Approved by AKZE	Modified 2023-09-29	FLIR
This document does not contain any export-controlled information.			Sheet 3(3)
Denomination Basic dimension drawing Exx			Rev E
Size A3			Drawing No T130127
Scale 1:2			

Declaration of conformity

The full text of the Declaration of conformity is available at the following internet address:
<http://support.flir.com/resources/5v82>.

28.1 Introduction

Calibration of a thermal camera is a prerequisite for temperature measurement. The calibration provides the relationship between the input signal and the physical quantity that the user wants to measure. However, despite its widespread and frequent use, the term “calibration” is often misunderstood and misused. Local and national differences as well as translation-related issues create additional confusion.

Unclear terminology can lead to difficulties in communication and erroneous translations, and subsequently to incorrect measurements due to misunderstandings and, in the worst case, even to lawsuits.

28.2 Definition—what is calibration?

The International Bureau of Weights and Measures¹⁵ defines *calibration*¹⁶ in the following way:

an operation that, under specified conditions, in a first step, establishes a relation between the quantity values with measurement uncertainties provided by measurement standards and corresponding indications with associated measurement uncertainties and, in a second step, uses this information to establish a relation for obtaining a measurement result from an indication.

The calibration itself may be expressed in different formats: this can be a statement, calibration function, calibration diagram¹⁷, calibration curve¹⁸, or calibration table.

Often, the first step alone in the above definition is perceived and referred to as being “calibration.” However, this is not (always) sufficient.

Considering the calibration procedure of a thermal camera, the first step establishes the relation between emitted radiation (the quantity value) and the electrical output signal (the indication). This first step of the calibration procedure consists of obtaining a homogeneous (or uniform) response when the camera is placed in front of an extended source of radiation.

As we know the temperature of the reference source emitting the radiation, in the second step the obtained output signal (the indication) can be related to the reference source’s temperature (measurement result). The second step includes drift measurement and compensation.

To be correct, calibration of a thermal camera is, strictly, not expressed through temperature. Thermal cameras are sensitive to infrared radiation: therefore, at first you obtain a radiance correspondence, then a relationship between radiance and temperature. For bolometer cameras used by non-R&D customers, radiance is not expressed: only the temperature is provided.

28.3 Camera calibration at FLIR Systems

Without calibration, an infrared camera would not be able to measure either radiance or temperature. At FLIR Systems, the calibration of uncooled microbolometer cameras with a measurement capability is carried out during both production and service. Cooled cameras with photon detectors are often calibrated by the user with special software. With this type of software, in theory, common handheld uncooled thermal cameras could be calibrated by the user too. However, as this software is not suitable for reporting

15. <http://www.bipm.org/en/about-us/> [Retrieved 2017-01-31.]

16. <http://jcg.m.bipm.org/vim/en/2.39.html> [Retrieved 2017-01-31.]

17. <http://jcg.m.bipm.org/vim/en/4.30.html> [Retrieved 2017-01-31.]

18. <http://jcg.m.bipm.org/vim/en/4.31.html> [Retrieved 2017-01-31.]

purposes, most users do not have it. Non-measuring devices that are used for imaging only do not need temperature calibration. Sometimes this is also reflected in camera terminology when talking about infrared or thermal imaging cameras compared with thermography cameras, where the latter are the measuring devices.

The calibration information, no matter if the calibration is done by FLIR Systems or the user, is stored in calibration curves, which are expressed by mathematical functions. As radiation intensity changes with both temperature and the distance between the object and the camera, different curves are generated for different temperature ranges and exchangeable lenses.

28.4 The differences between a calibration performed by a user and that performed directly at FLIR Systems

First, the reference sources that FLIR Systems uses are themselves calibrated and traceable. This means, at each FLIR Systems site performing calibration, that the sources are controlled by an independent national authority. The camera calibration certificate is confirmation of this. It is proof that not only has the calibration been performed by FLIR Systems but that it has also been carried out using calibrated references. Some users own or have access to accredited reference sources, but they are very few in number.

Second, there is a technical difference. When performing a user calibration, the result is often (but not always) not drift compensated. This means that the values do not take into account a possible change in the camera's output when the camera's internal temperature varies. This yields a larger uncertainty. Drift compensation uses data obtained in climate-controlled chambers. All FLIR Systems cameras are drift compensated when they are first delivered to the customer and when they are recalibrated by FLIR Systems service departments.

28.5 Calibration, verification and adjustment

A common misconception is to confuse *calibration* with *verification* or *adjustment*. Indeed, calibration is a prerequisite for *verification*, which provides confirmation that specified requirements are met. Verification provides objective evidence that a given item fulfills specified requirements. To obtain the verification, defined temperatures (emitted radiation) of calibrated and traceable reference sources are measured. The measurement results, including the deviation, are noted in a table. The verification certificate states that these measurement results meet specified requirements. Sometimes, companies or organizations offer and market this verification certificate as a "calibration certificate."

Proper verification—and by extension calibration and/or recalibration—can only be achieved when a validated protocol is respected. The process is more than placing the camera in front of blackbodies and checking if the camera output (as temperature, for instance) corresponds to the original calibration table. It is often forgotten that a camera is not sensitive to temperature but to radiation. Furthermore, a camera is an *imaging* system, not just a single sensor. Consequently, if the optical configuration allowing the camera to "collect" radiance is poor or misaligned, then the "verification" (or calibration or recalibration) is worthless.

For instance, one has to ensure that the distance between the blackbody and the camera as well as the diameter of the blackbody cavity are chosen so as to reduce stray radiation and the size-of-source effect.

To summarize: a validated protocol must comply with the physical laws for *radiance*, and not only those for temperature.

Calibration is also a prerequisite for *adjustment*, which is the set of operations carried out on a measuring system such that the system provides prescribed indications corresponding to given values of quantities to be measured, typically obtained from measurement standards. Simplified, adjustment is a manipulation that results in instruments that measure correctly within their specifications. In everyday language, the term “calibration” is widely used instead of “adjustment” for measuring devices.

28.6 Non-uniformity correction

When the thermal camera displays “Calibrating...” it is adjusting for the deviation in response of each individual detector element (pixel). In thermography, this is called a “non-uniformity correction” (NUC). It is an offset update, and the gain remains unchanged.

The European standard EN 16714-3, Non-destructive Testing—Thermographic Testing—Part 3: Terms and Definitions, defines an NUC as “Image correction carried out by the camera software to compensate for different sensitivities of detector elements and other optical and geometrical disturbances.”

During the NUC (the offset update), a shutter (internal flag) is placed in the optical path, and all the detector elements are exposed to the same amount of radiation originating from the shutter. Therefore, in an ideal situation, they should all give the same output signal. However, each individual element has its own response, so the output is not uniform. This deviation from the ideal result is calculated and used to mathematically perform an image correction, which is essentially a correction of the displayed radiation signal. Some cameras do not have an internal flag. In this case, the offset update must be performed manually using special software and an external uniform source of radiation.

An NUC is performed, for example, at start-up, when changing a measurement range, or when the environment temperature changes. Some cameras also allow the user to trigger it manually. This is useful when you have to perform a critical measurement with as little image disturbance as possible.

28.7 Thermal image adjustment (thermal tuning)

Some people use the term “image calibration” when adjusting the thermal contrast and brightness in the image to enhance specific details. During this operation, the temperature interval is set in such a way that all available colors are used to show only (or mainly) the temperatures in the region of interest. The correct term for this manipulation is “thermal image adjustment” or “thermal tuning”, or, in some languages, “thermal image optimization.” You must be in manual mode to undertake this, otherwise the camera will set the lower and upper limits of the displayed temperature interval automatically to the coldest and hottest temperatures in the scene.

FLIR Systems was established in 1978 to pioneer the development of high-performance infrared imaging systems, and is the world leader in the design, manufacture, and marketing of thermal imaging systems for a wide variety of commercial, industrial, and government applications. Today, FLIR Systems embraces five major companies with outstanding achievements in infrared technology since 1958—the Swedish AGEMA Infrared Systems (formerly AGA Infrared Systems), the three United States companies In-digo Systems, FSI, and Inframetrics, and the French company Cedic.

Since 2007, FLIR Systems has acquired several companies with world-leading expertise:

- NEOS (2019)
- Endeavor Robotics (2019)
- Aeryon Labs (2019)
- Seapilot (2018)
- Acyclica (2018)
- Prox Dynamics (2016)
- Point Grey Research (2016)
- DVTEL (2015)
- DigitalOptics micro-optics business (2013)
- MARSS (2013)
- Traficon (2012)
- Aerius Photonics (2011)
- TackTick Marine Digital Instruments (2011)
- ICx Technologies (2010)
- Raymarine (2010)
- Directed Perception (2009)
- OmniTech Partners (2009)
- Salvador Imaging (2009)
- Ifara Tecnologías (2008)
- Extech Instruments (2007)

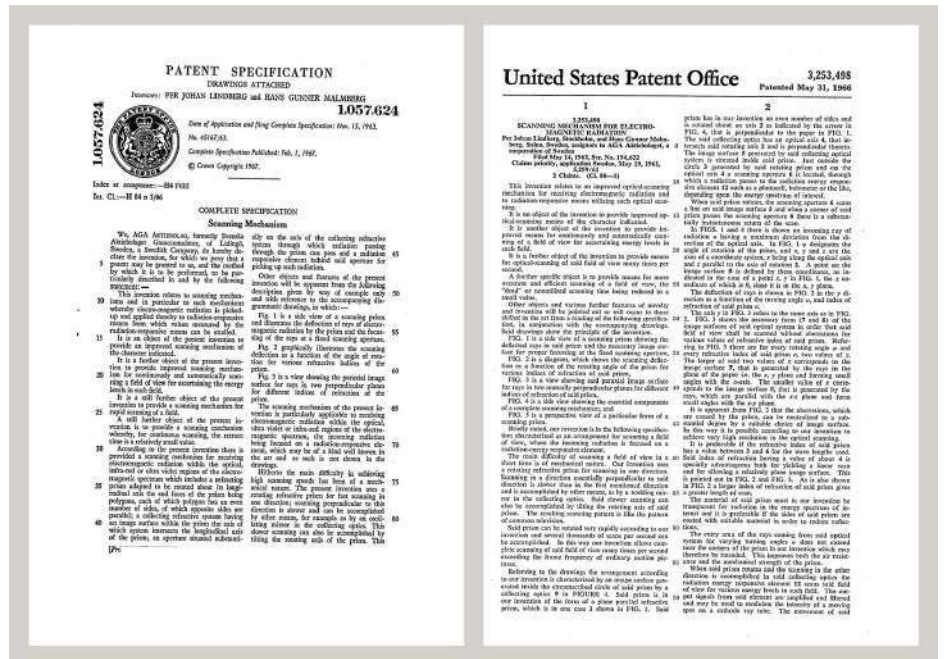

Figure 29.1 Patent documents from the early 1960s

FLIR Systems has three manufacturing plants in the United States (Portland, OR, Boston, MA, Santa Barbara, CA) and one in Sweden (Stockholm). Since 2007 there is also a manufacturing plant in Tallinn, Estonia. Direct sales offices in Belgium, Brazil, China,

France, Germany, Great Britain, Hong Kong, Italy, Japan, Korea, Sweden, and the USA—together with a worldwide network of agents and distributors—support our international customer base.

FLIR Systems is at the forefront of innovation in the infrared camera industry. We anticipate market demand by constantly improving our existing cameras and developing new ones. The company has set milestones in product design and development such as the introduction of the first battery-operated portable camera for industrial inspections, and the first uncooled infrared camera, to mention just two innovations.



1969: Thermovision Model 661. The camera weighed approximately 25 kg (55 lb.), the oscilloscope 20 kg (44 lb.), and the tripod 15 kg (33 lb.). The operator also needed a 220 VAC generator set, and a 10 L (2.6 US gallon) jar with liquid nitrogen. To the left of the oscilloscope the Polaroid attachment (6 kg (13 lb.)) can be seen.



2015: FLIR One, an accessory to iPhone and Android mobile phones. Weight: 36 g (1.3 oz.).

FLIR Systems manufactures all vital mechanical and electronic components of the camera systems itself. From detector design and manufacturing, to lenses and system electronics, to final testing and calibration, all production steps are carried out and supervised by our own engineers. The in-depth expertise of these infrared specialists ensures the accuracy and reliability of all vital components that are assembled into your infrared camera.

29.1 More than just an infrared camera

At FLIR Systems we recognize that our job is to go beyond just producing the best infrared camera systems. We are committed to enabling all users of our infrared camera systems to work more productively by providing them with the most powerful camera–software combination. Especially tailored software for predictive maintenance, R & D, and process monitoring is developed in-house. Most software is available in a wide variety of languages.

We support all our infrared cameras with a wide variety of accessories to adapt your equipment to the most demanding infrared applications.

29.2 Sharing our knowledge

Although our cameras are designed to be very user-friendly, there is a lot more to thermography than just knowing how to handle a camera. Therefore, FLIR Systems has founded the Infrared Training Center (ITC), a separate business unit, that provides certified training courses. Attending one of the ITC courses will give you a truly hands-on learning experience.

The staff of the ITC are also there to provide you with any application support you may need in putting infrared theory into practice.

29.3 Supporting our customers

FLIR Systems operates a worldwide service network to keep your camera running at all times. If you discover a problem with your camera, local service centers have all the equipment and expertise to solve it within the shortest possible time. Therefore, there is no need to send your camera to the other side of the world or to talk to someone who does not speak your language.



Website

<http://www.flir.com>

Customer support

<http://support.flir.com>

Copyright

© 2023, FLIR Systems, Inc. All rights reserved worldwide.

Disclaimer

Specifications subject to change without further notice. Models and accessories subject to regional market considerations. License procedures may apply. Products described herein may be subject to US Export Regulations. Please refer to exportquestions@flir.com with any questions.

Publ. No.: T810587
Release: AH
Commit: 94731
Head: 94786
Language: en-US
Modified: 2023-12-07
Formatted: 2023-12-11